

PHYSICS

Visit us at 3bscientific.com



Student Experiments
Mechanics
Waves

Energy and Environment
Thermodynamics
Optics

Electricity and Magnetism
Atomic and Nuclear Physics
Laboratory Equipment



Dr. Johannes Recht, *Business Field Manager Natural Sciences*

Dear Customer,

Are you fascinated by physics? Are you looking for opportunities to make your classes more exciting and more interesting? Would you like to be able to rely on your equipment sets and apparatus? Then have a look at this catalogue and take inspiration from the many new items inside. First let us point out some of the highlights of our constantly growing assortment of physics equipment:

Our high-quality **student experiment kits** have now been expanded to cover the following topics:

- Solar energy
- Electricity
- Ultrasonic waves
- Mechanical oscillations and waves

All student experiments kits naturally include detailed experiment instructions for both teachers and students.

The subject of **mechanics** is represented by an inexpensive version of Kater's reversible pendulum along with two new experiments for the investigation of elastic deformation and for the determining the modulus of elasticity, i.e. the shear modulus.

The section covering the subjects of **sound and ultrasound** has also been supplemented with some exceptional innovations:

- All new Kundt's tube with custom-made peripheral equipment
- Quincke's tube for investigating resonance
- The "Sound propagation in rods" and "Stereophonic hearing" equipment sets
- Equipment for experiments on ultrasonic computer tomography

Additional **highlights** include a compact solution for carrying out the Millikan experiment, the newly added Pockel's cell as well as apparatus for investigating the Hall effect in metals. In addition to this, we have upgraded the well-established ESCOLA analogue multimeter to make it even safer than before.

We hope you enjoy browsing through our catalogue and look forward to your feedback and orders. Naturally, our team of experts is always at your disposal should you need personal consultation.

With kind regards,

Dr. Johannes Recht
Business Field Manager Natural Sciences

► **New:** 3B Scientific® Physics Experiments Catalogue for Schools and Colleges with over 100 demonstration and practical experiments.

All you have to do is contact us and we will be happy to send you a copy of our experiment catalogue. You can find the catalogue to view as a PDF, for downloading or for ordering under "Request catalogue" in the "Customer Service" area of our web site.



Committed to quality

3B Scientific provides you with good quality at fair prices. Our sophisticated quality management complies with the ISO 9001 standards and the Worlddidac Quality Charter and is regularly approved by independent experts.

That's something you can rely on.



CONTENTS

4 NEW PRODUCTS	99 Mechanical waves	210 Charger and Discharger
8 STUDENT EXPERIMENTS	103 Sound	211 Electro-chemistry
8 3B STUDENT <i>Kit</i>	111 Ultrasound	214 Magnetism
15 Acoustics kit	120 ENERGY AND THE ENVIRONMENT	216 Magnetic fields
16 Student experiment kits (SEK)	120 Fuel cells / Solar energy	222 Conductors in magnetic fields
32 Kröncke optical system for student exercises	121 Greenhouse effect	224 Induction
34 Basic student experiments	122 Weather	228 Demountable transformer
35 Light box	123 Noise	231 Tesla coil transformer
36 Regenerative energy	124 HEAT AND THERMODYNAMICS	231 Free electrons in gases and in vacuum
37 Gas detector GASTEC	124 Thermometer	246 ATOMIC AND NUCLEAR PHYSICS
38 COMPUTER AIDED EXPERIMENTATION	128 Equivalent of heat	246 Periodic table of the elements
38 3B NET <i>lab</i> [™]	129 Calorimeters	247 Scanning tunneling microscope
39 3B NET <i>log</i> [™]	130 Thermal expansion	248 Model crystals
40 Sensors	133 Heat flow	249 Molecule building sets
47 Fourier analysis	134 Radiation of heat	250 Atomic orbitals
48 MECHANICS	136 Heat conduction	251 Millikan's experiment
48 Mechanics on a whiteboard	137 Gas laws	252 Fundamentals of atomic physics
49 Measurement of time	141 Cyclic processes	254 Franck-Hertz experiment
50 Measurement of length	146 LIGHT AND OPTICS	258 Fluorescence of sodium
51 Volume measurement	146 Optics on a whiteboard	258a-h X-ray apparatus
52 Dynamometers	149 Geometric optics	259 Radioactivity
53 Helical Springs	150 Kröncke optics	262 ESR/NMR
54 Balance weights	152 NEVA optical system	264 Hall effect in semiconductors
56 Gravitation / Astronomy	153 Optics using an optical bench U	265 Hall effect in metals
57 Statics	154 Optics using an optical bench D	266 INSTRUMENTATION
58 Friction	156 Optical lamps on stem	266 Power supplies
59 Simple machines	157 Optical components on stem	272 Function generators
61 Linear motion	160 Newton's rings / Fresnel mirror	275 Analogue oscilloscopes
64 Motion in a plane	161 Geometrical diaphragms	276 Digital oscilloscopes
67 Free fall / Uniform acceleration	162 Diffraction elements	278 Hand-held analogue measuring instruments
68 Vertical and horizontal trajectories	165 Filters	280 Hand-held digital measuring instruments
71 Physics on a small budget	166 Prisms / Optical crystals	284 Digital counters
72 Rotational motion	168 Faraday Effect	285 Rotational motion
74 Gyroscope	169 Wave optics using a laser	286 Magnetic fields
75 Oscillations	170 Colour	287 Microvoltmeter / Amplifier
83 Buoyancy	172 CCD HD Sensor	288 Laboratory scales
84 Density and volume	173 Pockels effect	290 Magnetic stirrers
86 Pressure	174 Polarisation	291 Heat sources
87 Surface tension	176 Spectrum tubes and spectrum lamps	292 Video cameras
88 Viscosity	178 Spectrometers	294 Microscopes
89 Elastic deformation	182 Mach-Zehnder interferometer	295 Various
90 Vacuum	183 Michelson interferometer	296 LAB MATERIAL
92 Vacuum pumps with hose connections	184 Solid-state laser physics	296 Stands, clamps and accessories
93 Vacuum pumps with flange connections	188 Equipment sets	298 Tubing
94 Aerodynamics	190 Speed of light	299 Experiment leads and cables
95 Laminar flow	191 Eye and vision	301 Various
96 WAVES AND SOUND	192 ELECTRICITY AND MAGNETISM	302 Glassware
96 Wave optics	192 Electrostatics	303 HISTORICAL EXPERIMENTS
98 Water waves	198 Electrical circuits	304 ALPHABETICAL INDEX
	206 3B Plug-in component system	314 NUMERICAL INDEX
		318 MORE PRODUCT RANGES

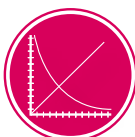

LEGEND

This tip names some experiments from our physics & engineering experiments catalogue which are suitable for the product. You can find these experiments on our web site 3bscientific.com by searching for the number listed.

UE2020200

NEW PRODUCTS

Apparatus for Measuring Young's Modulus

U8557260

page 89

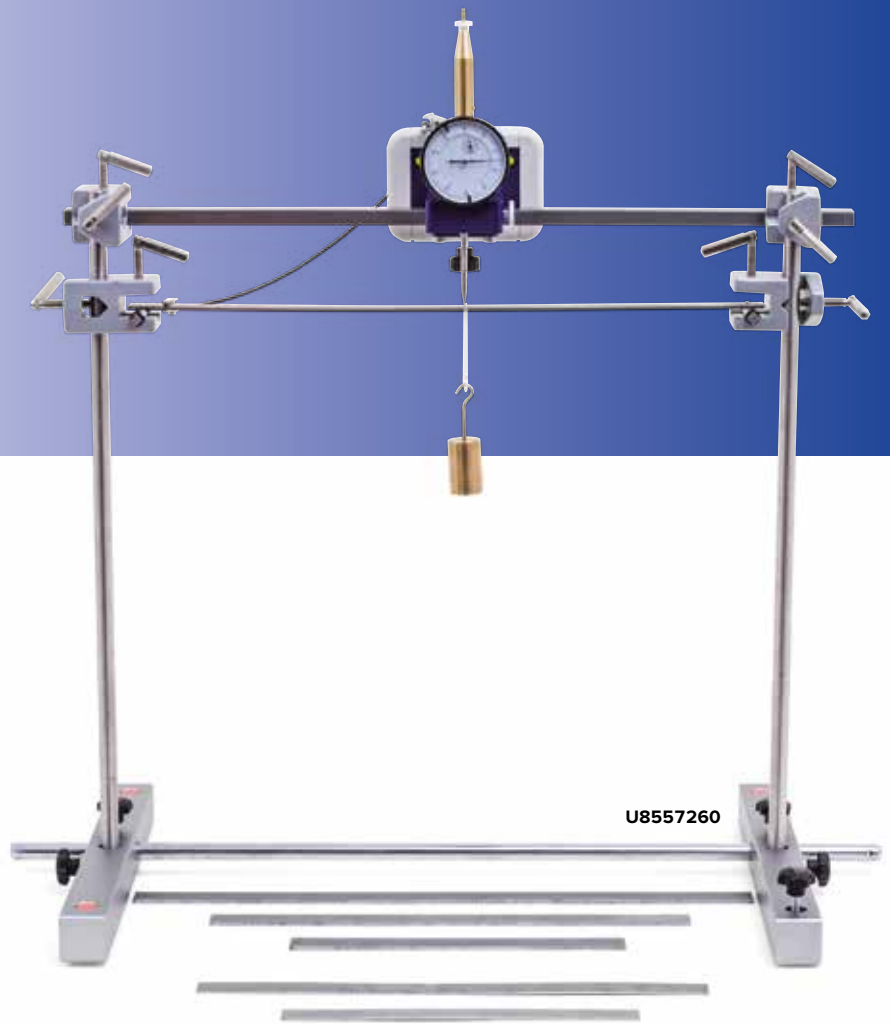

U8557260

Torsion Apparatus

U8557300

page 89

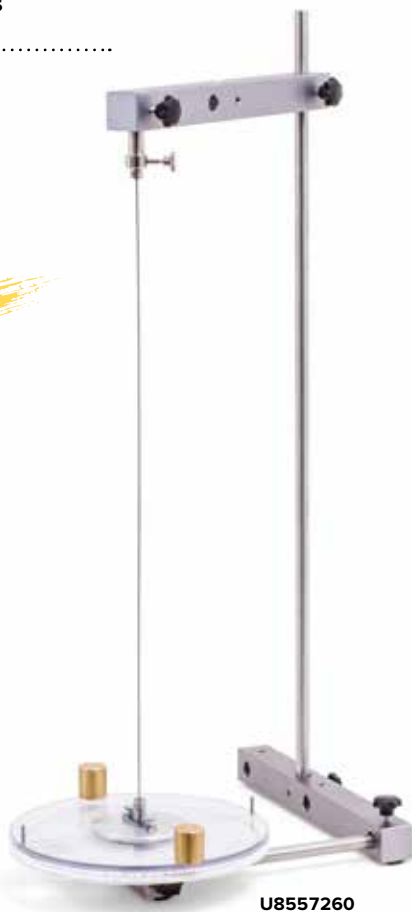

U8557260

Quincke's Resonance Tube

U8557190

page 103



U8557300



U30045

page 77

Kater's Reversible Pendulum
U8557170



U8557250

page 173

Pockels Cell on Stem
U8557250

Millikan's Apparatus (230 V, 50/60 Hz)
U20700-230

Millikan's Apparatus (115 V, 50/60 Hz)
U20700-115



U20700-230

Our low-cost compact solution

page 251

Equipment Set "Sound Propagation in Rods"
(230 V, 50/60 Hz)

U8557180-230

Equipment Set "Sound Propagation in Rods"
(115 V, 50/60 Hz)

U8557180-115

page 107



U8557180-230

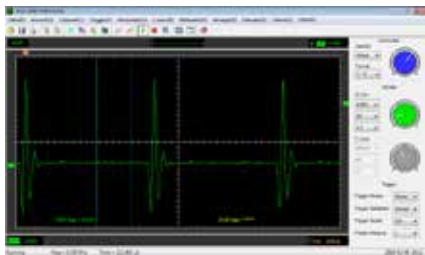

Propagation of longitudinal waves:
wave packets in a long rod

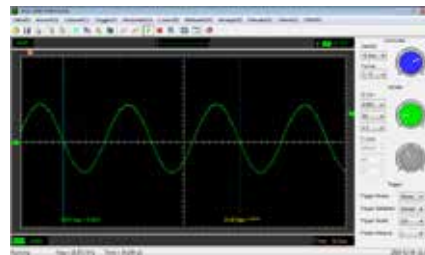

Propagation of longitudinal waves:
Sinusoidal vibration in a short rod

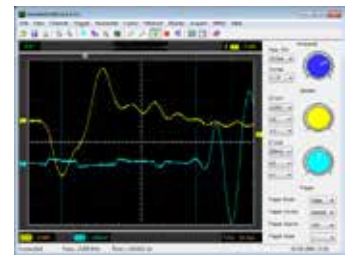

Propagation of shear waves in rods

Hall Effect in Metals

Copper Sample for Hall Effect
U8557400

Zinc Sample for Hall Effect
U8557410

Holder for Hall Effect
U8557420

page 265



New Products

Equipment Set "Stereophonic Hearing"
U8557320

page 107



U8557320

Cat Scan

CT Scanner
U10630

page 119



U10630



U10633

CT Measuring Trough
U10633



U10631

CT Controller
U10631



U10632

CT-Sample
U10632

New Products

3B STUDENT Kit Student Experiments for Lower Secondary Level

The versatile 3B STUDENT Kits allow students in lower secondary level to work independently in setting up and carrying out a comprehensive range of basic experiments on the topics of mechanics, heat, optics, electrostatics and electricity. Detailed instructions for the experiments, divided into pages for students and pages for teachers, help the students to perform the experiments and enable the teachers to make the necessary preparations.

Each equipment set-up enables students to work in pairs and requires a bench area of only 400 mm x 250 mm, which is sufficient to ensure a clear and stable set-up. The robust components are made of anodised aluminium, plastic or glass.

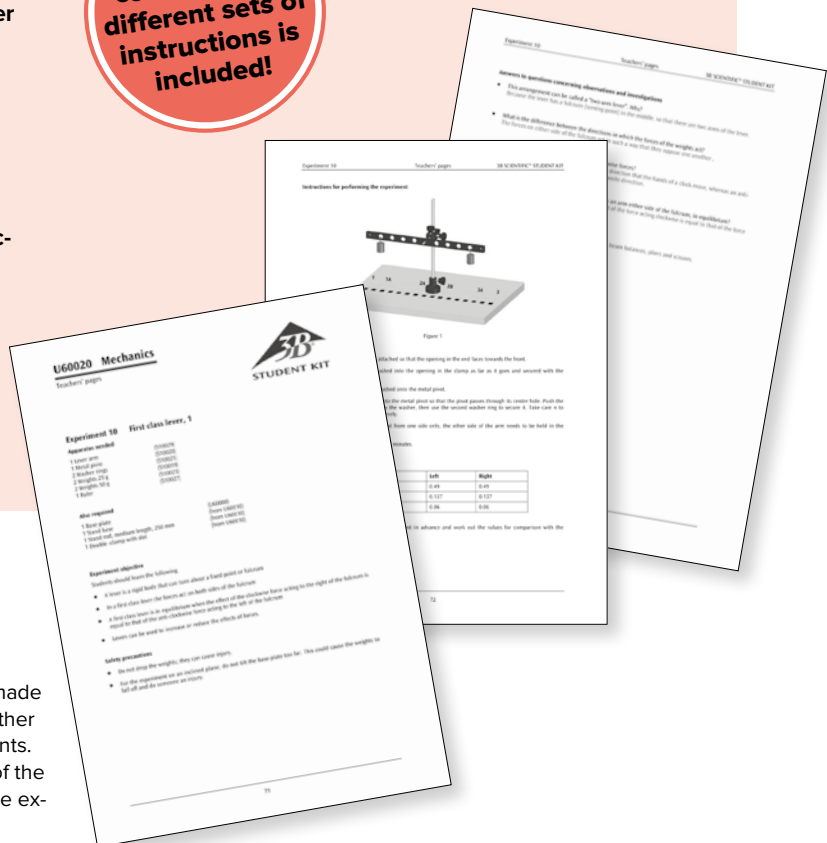
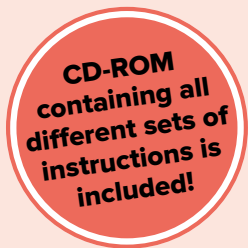

STUDENT Kit – Basic Set

Basic set of apparatus for use with STUDENT Kits for mechanics (U60020) and heat (U60040). Consisting of a robust base-plate made of plastic, stands and clamps made of anodised aluminium and other components that are used in both mechanics and heat experiments. In a robust plastic box with foam inserts moulded to the shapes of the items plus a transparent lid. Includes a CD with instructions for the experiments.

Contents:

- 1 Base-plate
- 2 Stand bases
- 2 Stand rods, 360 mm
- 1 Stand rod, 250 mm
- 2 Stand rods, 100 mm
- 2 Double clamps with slot
- 1 Clip, 8 mm diam.
- 1 Clip 22 mm diam.
- 1 Clip 27 mm diam.
- 1 Beaker, 500 ml
- 1 Test tube
- 1 Glass tube, 50 mm
- 1 Glass tube, 250 mm
- 1 Silicone tube, 500 mm x 6 mm diam.
- 4 g Glycerine
- 1 CD with sets of instructions for experiments

U60011

Please ask for quantity discounts on class sets for 8 pieces and more



U60011

STUDENT Kit – Mechanics

Set of apparatus for carrying out 25 basic student experiments on the mechanics of solids, liquids, and gases. In a robust plastic box with foam inserts moulded to the shapes of the items and a transparent lid. The experiments are designed to occupy as little space as possible on the base-plate of the STUDENT Kit basic set (U60011), while remaining clear and easy to perform. Includes a CD with instructions for the experiments.

U60020

Additionally required:

U60011 STUDENT Kit – Basic Set

Contents:

1 Steel leaf spring	1 Aluminium block
1 Lever arm	1 Wooden block
1 Ruler	1 Silicone tube, 500 mm x 3 mm diam.
1 Pulley	1 Tubing connector
1 Pulley with hook	1 Clip, 8 mm diam.
1 Weight, 100 g	1 Clip, 14 mm diam.
3 Weights, 50 g	1 Syringe, 60 ml
2 Weights, 25 g	1 Syringe, 30 ml
1 Dynamometer, 2 N	1 Plastic sphere
1 Metal pivot	1 Rubber stopper (30 mm x 31/25 mm diam.)
4 Washer rings to fit metal pivot	1 Funnel, 40 mm diam.
1 Pulley with cord	1 U-tube manometer
1 Trolley	1 Measuring cylinder
1 Friction pad	100 g Modelling clay
1 Coil spring	
1 Iron block	



U60020

Includes 25 Experiments on the Subject of Mechanics:

- Effects of forces
- Action and reaction
- Deformation by forces (2 experiments)
- Masses and densities of bodies
- Friction
- Second class lever
- First class lever (2 experiments)
- Fixed pulley
- Moving pulleys
- Combinations of fixed and moving pulleys (block and tackle)
- Inclined plane (2 experiments)
- Connected vessels
- Pressure in liquids
- Principle of the U-tube manometer
- Pressure due to weight of fluids
- Buoyancy in liquids
- Floating and sinking
- Air as a body
- Pressure and volume
- Temperature and volume
- Effects of atmospheric pressure

Equipment Mechanics:

U60020 STUDENT Kit – Mechanics

U60011 STUDENT Kit – Basic Set



First class lever

STUDENT Kit – Heat

Set of apparatus for carrying out 10 basic student experiments on heat. In a robust plastic box with foam inserts moulded to the shapes of the items and a transparent lid. The experiments are designed to occupy as little space as possible on the base-plate of the STUDENT Kit basic set (U60011), while remaining clear and easy to perform. Includes a CD with instructions for the experiments.

Contents:

- 1 Conical flask, 100 ml
- 1 Bimetallic strip
- 1 Concave mirror mounted on stem
- 1 Aluminium rod 200 mm
- 1 Thermometer, -10°C – $+100^{\circ}\text{C}$
- 1 Glass tube with 90° bend
- 1 Rubber stopper, 25 mm x 24/19 mm diam.
- 1 Spirit burner
- 1 Ceramic mat

U60040

Additionally required:
U60011 STUDENT Kit – Basic Set

**Please ask for quantity discounts
 on class sets for 8 pieces and more**

**CD-ROM
 containing all
 different sets of
 instructions is
 included!**



U60040

Includes 10 Experiments on the Subject of Heat:

- Principle of a thermometer
- Heating of solid bodies
- Heating of liquid bodies
- Heating of gases
- Behaviour of bimetallic objects
- Conduction of heat
- Radiation of heat
- Condensation
- Distillation
- Temperature of mixtures

Equipment Heat:

- U60040 STUDENT Kit – Heat**
- U60011 STUDENT Kit – Basic Set**

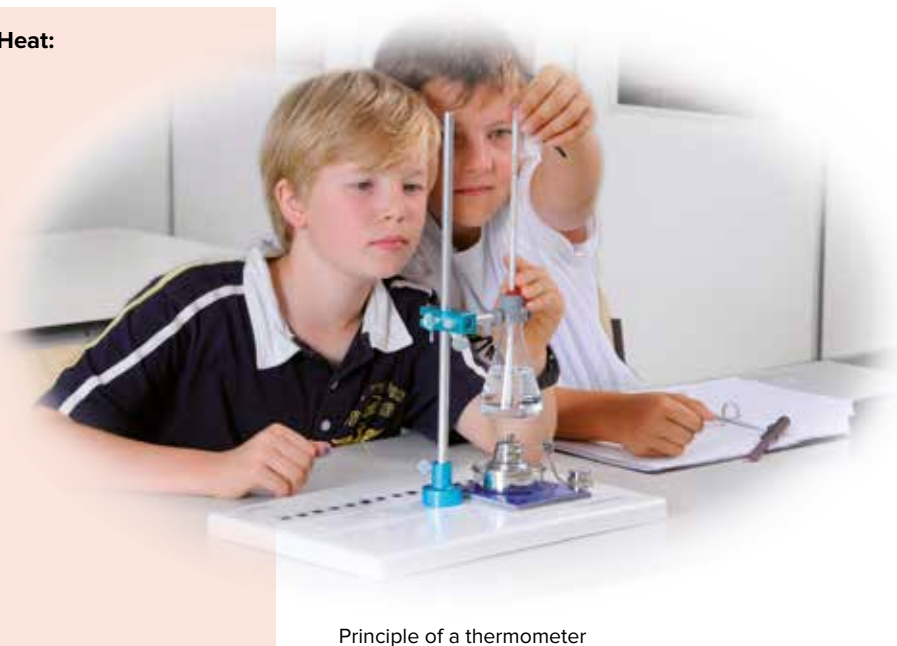

Principle of a thermometer

STUDENT Kit – Optics

Set of apparatus for carrying out 23 basic student experiments in optics. In a robust plastic box with foam inserts moulded to the shapes of the items and a transparent lid. Includes a CD with instructions for the experiments. The experiments are designed to occupy as little space as possible on the included optical bench, while remaining clear and easy to perform.

Contents:

- 2 Lenses, $f = +100$ mm
- 1 Lens, $f = +50$ mm
- 1 Lens, $f = -100$ mm
- 1 Lens, $f = +300$ mm
- 1 Diaphragm holder
- 1 Plug-in power supply unit for optical lights
- 1 Optical light
- 1 Overlay mask protractor
- 1 Projection screen/experiment table
- 1 Optic bench
- 2 Tea lights
- 1 Opaque body
- 1 Single aperture slot
- 1 Triple aperture slot
- 1 Colour slide M-Y-C
- 1 F diaphragm
- 1 Flexible mirror
- 1 Coplanar board
- 1 Semicircular body
- 1 Converging lens
- 1 Diverging lens
- 1 Right-angled prism
- 2 Sheets of graph paper, transparent DIN A5
- 1 Scale



U60050-230
U60050-115

STUDENT Kit Optics (230 V, 50/60 Hz)

U60050-230

STUDENT Kit Optics (115 V, 50/60 Hz)

U60050-115

Includes 23 Experiments on the Subject of Optics:

- Propagation of light
- Light and shadows
- Reflection at a plane mirror
- Concave and convex mirrors
- Refraction of light (2 experiments)
- Refractive index
- Optical lenses (paths of rays)
- Focal point of convergent lenses
- Focal length of convergent lenses
- Formation of images with converging lenses
- Laws of images
- Magnifying glasses
- Function of the eye
- Function of spectacles (2 experiments)
- Principle of a camera
- Principle of a slide projector
- Principle of a Galilean telescope
- Principle of an astronomical telescope
- Principle of a microscope
- Breaking down light into its components
- Mixing of colours

Equipment Optics:

U60050-230 STUDENT Kit – Optics (230 V, 50/60 Hz)

or

U60050-115 STUDENT Kit – Optics (115 V, 50/60 Hz)



Principle of a slide projector

new

STUDENT Kit – Electricity

Set of apparatus for carrying out 28 fundamental student experiments on electricity. Stored in a tough Gratnells tray with foam inlay featuring recesses moulded to the shape of the apparatus and covered by a transparent lid. Circuits are assembled using components in plug-in housings plugged into a plug-in board. Power is supplied via 2 D-cell, LR20, 1.5 V batteries (batteries not included) or via an external power supply. Includes a CD with instructions for the experiments.

U60070.....

STUDENT Kit – Electricity



Contents:

- 1 Plug-in Board for Components
- 2 Battery Holders
- 1 Set of Conductors and Non-Conductors
- 1 Set of 10 E10 lamps; 1.3 V, 60 mA
- 1 Set of 10 E10 lamps; 3.8 V, 300 mA
- 3 E10 lamp sockets
- 2 Change-over switches
- 1 Toggle switch, single pole
- 1 Push-button (NO), single pole
- 1 Roll of chrome-nickel wire
- 1 Roll of constantan wire
- 1 Roll of iron wire
- 1 Set of 10 connecting plugs
- 6 Connecting plugs, 4 mm
- 6 Crocodile clips
- 1 Potentiometer, 220 Ω
- 1 Linear Resistor, 47 Ω, 2 W
- 2 Linear Resistors, 100 Ω, 2 W
- 2 Zinc plates
- 2 Copper plates
- 2 Carbon plates
- 1 Glass trough
- 1 Set of 3 experiment leads, red
- 1 Set of 3 experiment leads, blue
- 1 Roll of experiment cord
- 1 Weight, 50 g
- 1 Tea candle

Includes Instructions for 28 Experiments on Electricity:

- Simple electric circuits (2x)
- Electrical conductors and insulators
- Production of heat and light
- Various sources of electricity *
- Conduction in liquids *
- Single-pole change-over switches (SPDT)
- Two-way switches
- Measurement of current in a simple electric circuit **
- Measurement of voltage in a simple electric circuit **
- Incandescent lamps connected in series
- Incandescent lamps connected in parallel
- Terminal voltage and open-circuit (no-load) voltage **
- Batteries connected in series and parallel **
- Battery made from a lemon **
- Relationship between voltage and current determined by varying voltage * / **
- How electrical power depends on other variables in an electric circuit * / **
- How electrical work depends on other variables in an electric circuit * / **
- Ohmic resistance * / **
- How electrical resistance depends on temperature (2x) * / **
- How electrical resistance depends on the length of the wire * / **
- How electrical resistance depends on the cross section of the wire * / **
- How electrical resistance depends on the material of the wire * / **
- Resistivity * / **
- Resistors connected in series * / **

- Resistors connected in parallel * / **
- Variable resistors
- Potentiometers * / **

Equipment Electricity:

U60070 STUDENT Kit – Electricity

U117601-230 DC power supply, 0 – 12 V, 3 A (230 V; 50/60 Hz)

or

U117601-115 DC power supply, 0 – 12 V, 3 A (115 V; 50/60 Hz)

(for experiments marked *)

U8557330 Analogue Multimeter ESCOLA 30

(for experiments marked **)

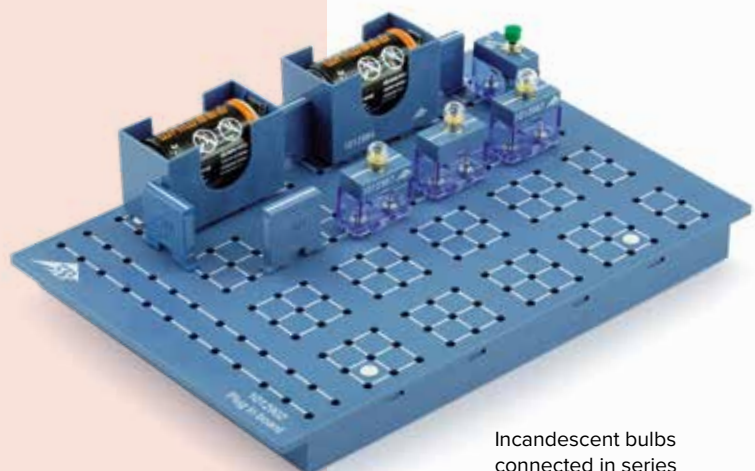

Incandescent bulbs connected in series

Student Experiments

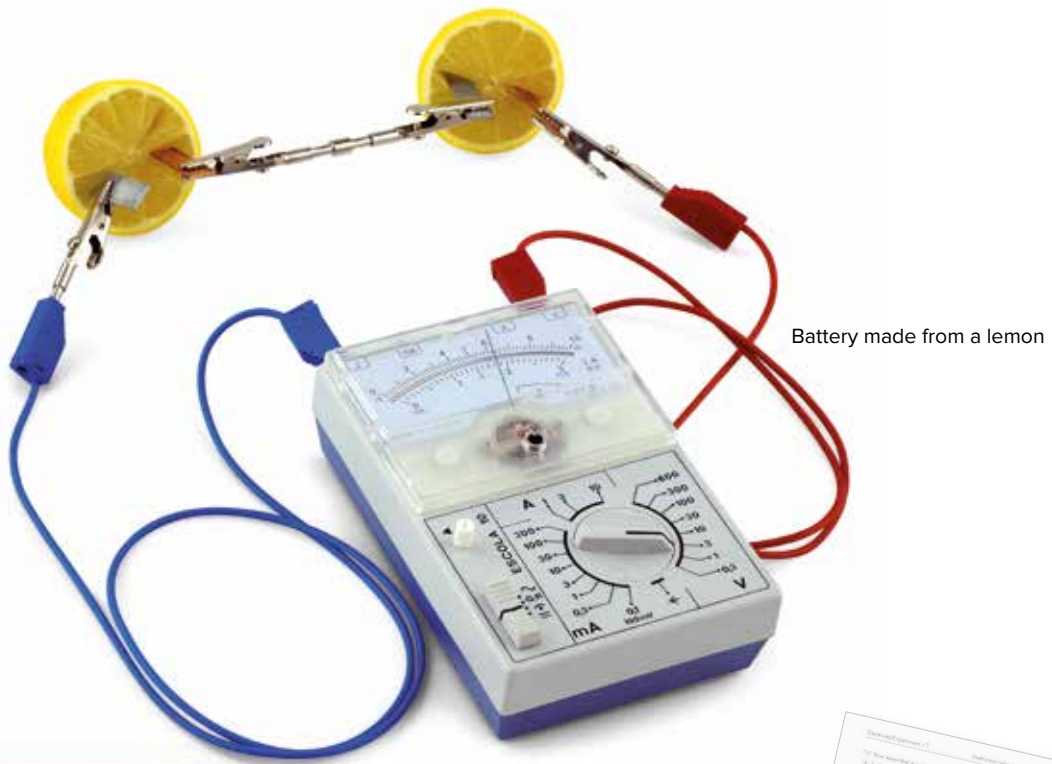

Battery made from a lemon

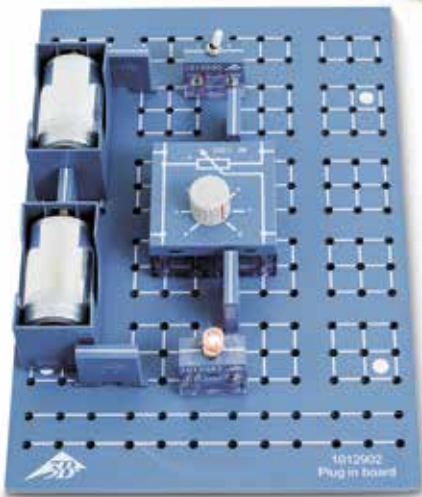

Variable resistors

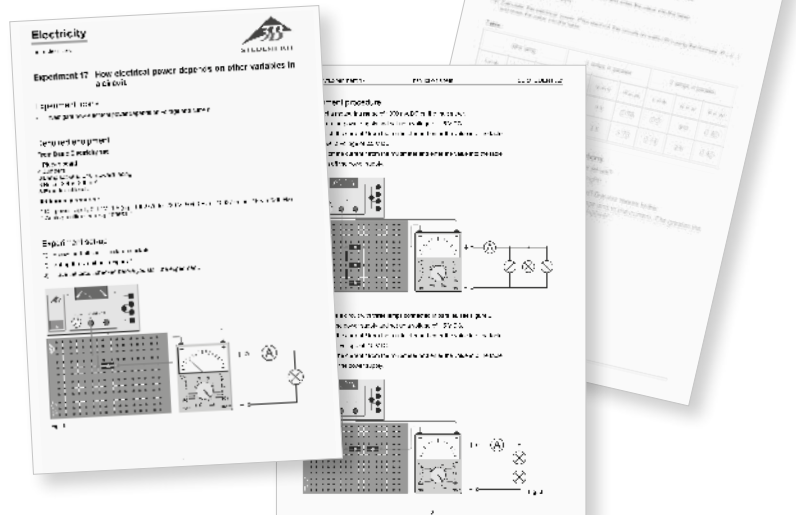

Please ask for quantity discounts on class sets for 8 pieces and more

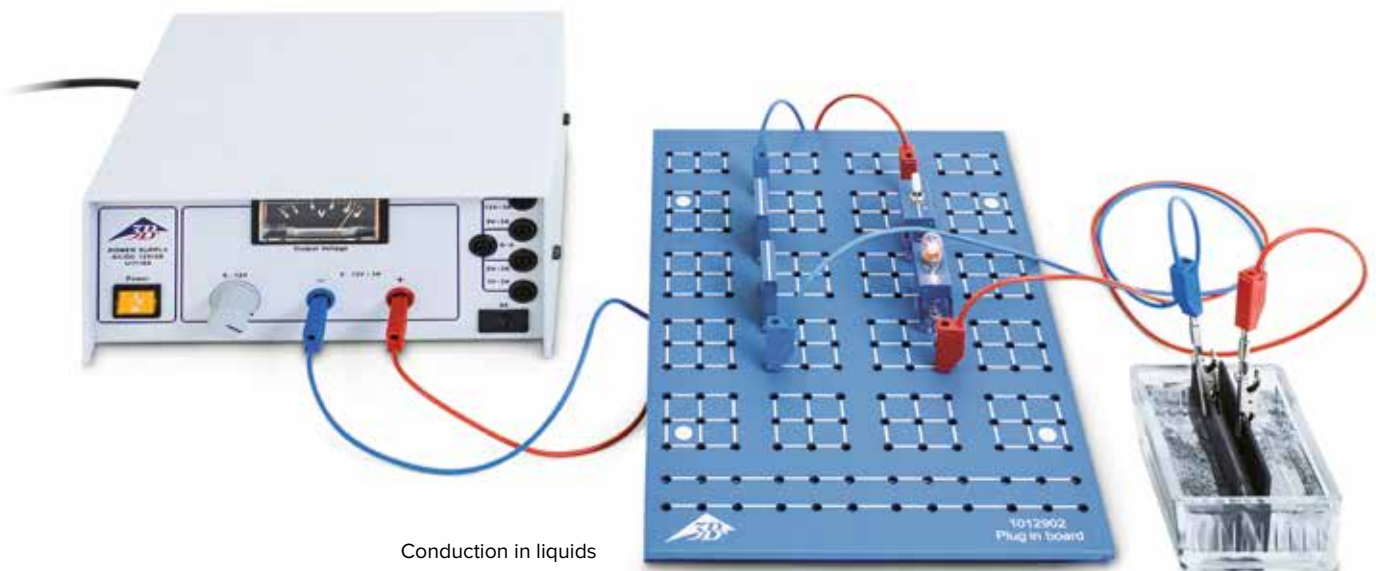

Conduction in liquids

STUDENT Kit – Electrostatics

Set of apparatus for carrying out 15 basic student experiments on electrostatics. Including electroscopes, charge indicator, charge storage unit and Piezo charger. In a robust plastic box with foam inserts moulded to the shapes of the items and a transparent lid. Includes a CD with instructions for the experiments. The experiments are designed to occupy as little space as possible in the apparatus frame, while remaining clear and easy to perform.

Contents:

- 1 Stand base
- 1 Apparatus frame
- 2 Aluminium rods
- 1 Aluminium rod with magnet
- 1 Electroscope
- 1 Plastic plate, angled
- 1 Plastic rod
- 1 Glass rod
- 1 Conductor body
- 1 Set of needles
- 1 Spinner
- 1 Pendulum bob (polystyrene)
- 1 Screw-on needle
- 1 Set of plasticine
- 2 Experiment leads
- 1 Set of balloons
- 1 Set of papers with 1 plastic cloth
- 1 Set of metal strips
- 1 Piezo charger
- 1 Faraday cage
- 1 Faraday cup
- 1 Charge indicator
- 1 Charge storage unit
- 2 Capacitor plates
- 1 Dielectric

U60060

**Please ask for quantity discounts
on class sets for 8 pieces and more**

**CD-ROM
containing all
different sets of
instructions is
included!**



U60060

Includes 15 Experiments on the Subject of Electrostatics:

- Electrostatic charging of hair
- Forces on uncharged particles
- Charge indicator
- Forces between charged bodies
- Build your own electroscope
- Electroscope
- “Shock of hair”
- Demonstrating charge on a capacitor
- “Charge pendulum”
- “Spinner”
- Charging due to induction
- Transfer of charge using a “charge spoon”
- Faraday’s cup
- Faraday’s cage
- Plate capacitor

Equipment Electrostatics:

U60060 Student Kit – Electrostatics

“Shock of hair”

Acoustics Kit

Complete set of equipment for carrying out more than 30 student experiments on acoustics. In plastic tray with foam inlay.
 Dimensions: 530x375x155 mm³ approx.
 Weight: 4.5 kg approx.

Contents:

- 1 Monochord, with ruler and musical scale
- 1 Steel string
- 1 Perlon string
- 1 Spring balance on support
- 1 Reed pipe with 8 valves
- 1 Tuning fork with plotter pen, 21 Hz
- 1 Tuning fork, 440 Hz
- 1 Light-metal tuning fork, 1700 Hz
- 1 Pipe
- 1 Variable-length closed air column
- 1 Tuned open air column
- 1 Chladni disc with rod
- 1 Bell dome
- 1 Galton whistle
- 1 Kundt pipe with retaining clip
- 5 g Lycopodium powder in sprinkling cellar
- 1 Metallophone with beater
- 1 Rope for demonstrating waves
- 1 Helmholtz resonator, 70 mm diam.
- 1 Helmholtz resonator, 52 mm diam.
- 1 Helmholtz resonator, 40 mm diam.
- 1 Helmholtz resonator, 32 mm diam.
- 1 Screw clamp
- 1 Plastic block
- 1 Plunger



Acoustics Kit

U8440012

Representation of oscillations with a tuning fork with plotter pen

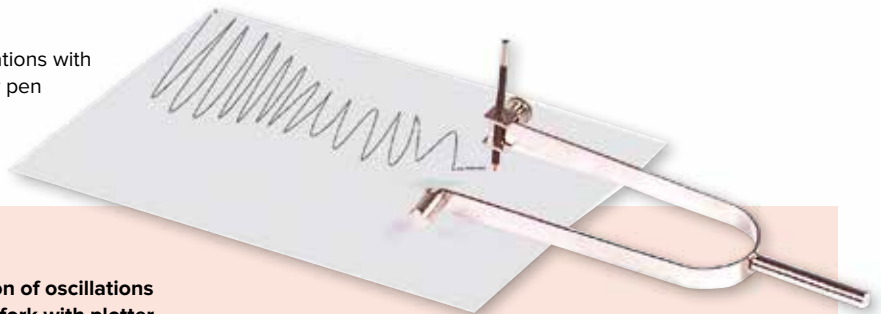

Experiment Topics:

- Noise, bangs, pure tones
- Vibrating air columns
- Whistles and pipes
- Vibrating bars, plates and bells
- Infra-sound
- Ultra-sound
- Tuning fork with plotter pen
- Travelling waves along a rope
- Velocity of propagation of sound
- Moving sources of sound (Doppler effect)
- Plate vibrations (Chladni figures)
- Vibrations of a bell
- Standing waves on a rope, overtones
- Sounds of musical instruments
- Representation of oscillations with a tuning fork with plotter pen
- Timbre of the human voice
- Measurement of wavelength (Kundt figures)
- Resonance
- Helmholtz ball resonators
- Sound analysis
- Loudness
- Pitch of string instruments
- Pitch of wind instruments
- Reed pipe
- C-major scale and its intervals
- Triads, harmonies
- Semitones, major and minor

The acoustics kit allows students to carry out numerous experiments on acoustics independently. A wide variety of sound sources are studied to begin with and the concepts of noise, bangs and tones as well as pitch and loudness are investigated. Waves along a rope are used to illustrate harmonic vibrations and overtones. There is also some extensive study of various different musical instruments. Different high-pitched tones are generated by means of a monochord and the ensuing intervals are calculated experimentally. These studies are expanded to other instruments and can easily lead over to a study of musical notes.

Student Experiments

Student Experiment Kits (SEK)

With the comprehensive and practical student experiment kits students can independently carry out numerous experiments on mechanics, heat, optics, electricity and magnetism, solar energy, oscillations and waves, or radioactivity. To help them there are detailed instructions for all the experiments. Each of the experiments only requires a small amount of space, but nevertheless an easily understood and stable set-up is always assured. The prescribed layouts for the experiment set-ups make it possible for teachers to quickly assess the progress and success achieved by individual students conducting the experiments.

SEK Mechanics

Set of equipment for carrying out 23 student experiments on the mechanics of solids. In a tough plastic box containing a foam insert with cut-outs for the equipment and featuring a transparent lid. Includes CD with experiment instructions. Experiments are set up and performed on the SEK base plate (U8408035) so that they are compact but still clear in their layout and objectives.

U8501000



Contents:

- 2 Stand rods with external and internal thread, 400 mm
- 1 Stand rod with external thread, 400 mm
- 2 Stand rods, 110 mm
- 2 Double clamps
- 1 Beam balance
- 2 Weighing pans with holders
- 1 Scale for balance
- 1 Axle rod for pulleys
- 1 Rolling pin with add-on weights
- 1 Block and tackle with two pulleys and two hooks
- 1 Block and tackle with two pulleys and one hook
- 1 Multiple pulley
- 1 Plastic pulley, 40 mm
- 4 Weights, 25 g
- 1 Weight, 50 g
- 1 Weight, 100 g
- 1 Magnetic base
- 1 Adjustable bracket
- 2 S-shaped hooks, 1 g
- 2 S-shaped hooks, 2 g
- 2 S-shaped hooks, 5 g
- 4 O-rings
- 1 Body for friction and inertia experiments
- 1 Set of plastic strips for friction experiment
- 1 Dynamometer 1 N
- 1 Dynamometer 2 N
- 1 Leaf spring, 330 mm
- 1 Coil spring with 2 eyelets, approx. 5 N/m
- 100 m of twine
- 2 Pointers
- 1 Measuring cylinder
- 1 Stand base for measuring cylinder
- 3 Strips of velour paper
- 1 Set square
- 1 Ruler

Please ask for quantity discounts on class sets for 8 pieces and more

Includes 23 Experiments on the Subject of Mechanics:

- Hooke's law
- Calibrating a dynamometer
- Deformation of a leaf spring
- Addition of forces acting along the same line
- Resolution of a force into two components
- Investigation of inertia
- Types of friction
- Laws of static and kinetic friction
- Equilibrium conditions for a first-class lever
- Equilibrium conditions for second and third-class levers
- Forces, paths and work with fixed pulleys
- Forces, paths and work with non-fixed pulleys
- Forces, paths and work with block and tackle
- Forces, paths and work with multiple pulleys
- Forces on an inclined plane
- Determining the volume of solid bodies
- Determining the mass of solid bodies (beam balance)
- Determination of density
- Determining the nature of a material by measuring density
- Specific weight and buoyancy
- Period of a string pendulum
- Determining gravitational acceleration with the aid of a string pendulum
- Period of a spring oscillator

Equipment mechanics:

U8501000 SEK Mechanics

U8408035 SEK Base Plate

SEK Base Plate

Tilt-resistant stainless-steel base with five special threads for the tilt-free insertion of stand rods, threads for mounting a dismantling transformer and numerous expansion slots for the insertion of electrical components. With stable and nonslip rubber feet. Dimensions: 400x245x15 mm³ approx.

U8408035

CD-ROM containing all different sets of instructions is included!

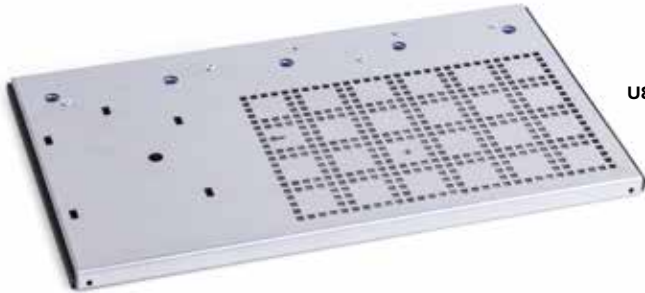

U8408035

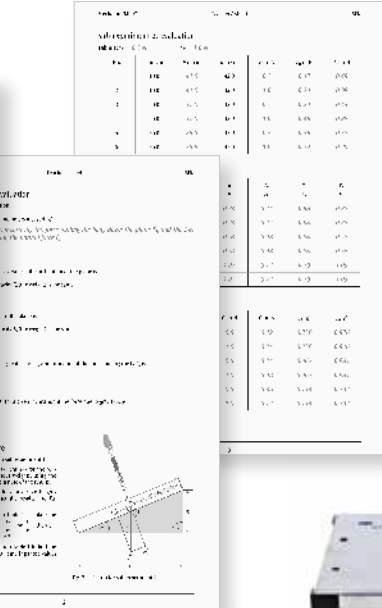
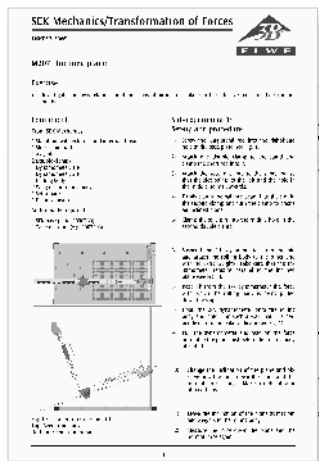

Block and tackle

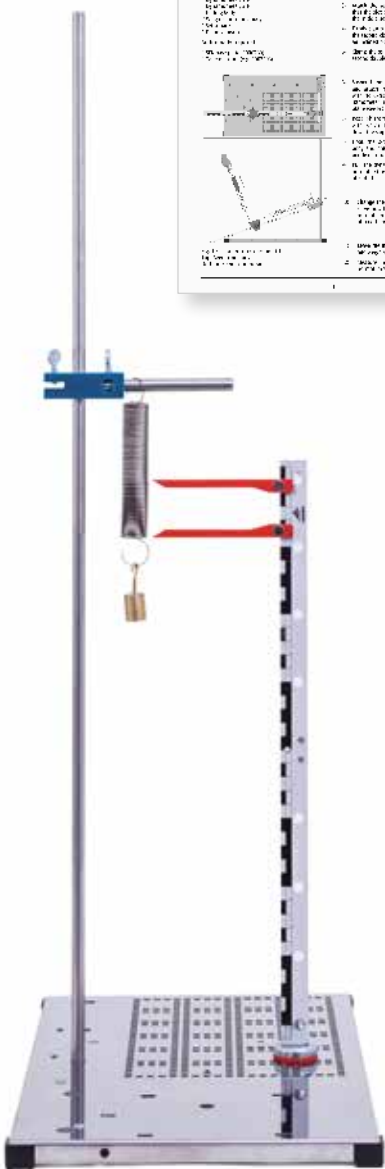

Hooke's law



Second and third-class levers

SEK Mechanics

Student Experiments

SEK Heat

Set of equipment for carrying out 22 basic student experiments on heat. In a tough plastic box containing a foam insert with cut-outs for the equipment and featuring a transparent lid. Includes CD with experiment instructions. Experiments are set up and performed on the SEK base plate (U8408035) so that they are compact but still clear in their layout and objectives.

U8502000

Contents:

- | | |
|--|--|
| 1 Stand rod with internal and external threads, 400 mm | 2 Thermometers, -10 – 110°C, 1 K, red liquid |
| 4 Wooden rods | 1 Capillary tube |
| 1 Metal tube, short | 1 Bimetal strip with 10-mm stub |
| 1 Pointer/hook | 10 Round filters |
| 1 Stirrer | 10 Sheets of thermal paper |
| 1 Steel tube | 1 Steel body |
| 1 Brass tube | 1 Lead body |
| 1 Aluminium tube | 1 Spirit burner |
| 1 Thermometer without scale, red liquid | 1 Beaker, 100 ml |
| | 1 Conical flask, 100 ml |
| | 1 Test tube holder with rod attachment |
| | 1 Test tube |
| | 1 Measuring cylinder, 50 ml |
| | 1 Calorimeter with heating filament, 200 ml |
| | 1 Rubber stopper with two holes |
| | 2 Rubber stoppers with one hole |
| | 1 10 g weight with hook |
| | 2 Double clamp |
| | 5 ml of food colouring |
| | 10 g of table salt |
| | 1 Holder for metal beaker |
| | 1 Metal beaker, black |
| | 1 Metal beaker, aluminium |
| | 4 g of glycerine |
| | 1 Hose |
| | 2 Round gaskets |
| | 1 Angle scale |
| | 10 Sheets of paper |
| | 5 Sheets of aluminium foil |



U8502000

Includes 22 Experiments on the Subject of Heat:

- Change in the volume of liquids due to heating
- Calibration of a thermometer
- Change in the volume of air due to changes in temperature
- Changes in state of an enclosed volume of air
- Changes in the length of solid bodies when heated
- Linear expansion coefficient
- Investigations using bimetal strips
- Transfer of heat in solid bodies
- Transfer of heat in liquids
- Transfer of heat in gases
- Radiation of heat
- Slowing down the transport of heat
- Temperature changes when liquids are heated
- Fundamental equation of thermodynamics
- Mixing water of differing temperatures, temperature of mixture
- Specific heat capacity of a calorimeter
- Specific heat capacity of metals
- Initial temperature of a metal body heated in a flame
- Conversion of electrical energy into heat
- Temperature changes when ice melts
- Specific latent heat of melting ice
- Boiling and condensation of water
- Distillation
- Evaporation of liquids (what it depends on and heat loss due to evaporation)

Equipment Heat:

U8502000 SEK Heat

U8408035 SEK Base Plate

Please ask for quantity discounts on class sets for 8 pieces and more



Changes in the length of solid bodies when heated

CD-ROM containing all different sets of instructions is included!

SEK Thermodynamics/Heat transfer

K205: Investigation of the transfer of heat

Experiment 1: Heat transfer in solid bodies

Experiment 2: Specific heat capacity of metals

Time	Temperature of water	Temperature of metal
0	20.0	100.0
1	21.0	95.0
2	22.0	90.0
3	23.0	85.0
4	24.0	80.0
5	25.0	75.0
6	26.0	70.0
7	27.0	65.0
8	28.0	60.0
9	29.0	55.0
10	30.0	50.0

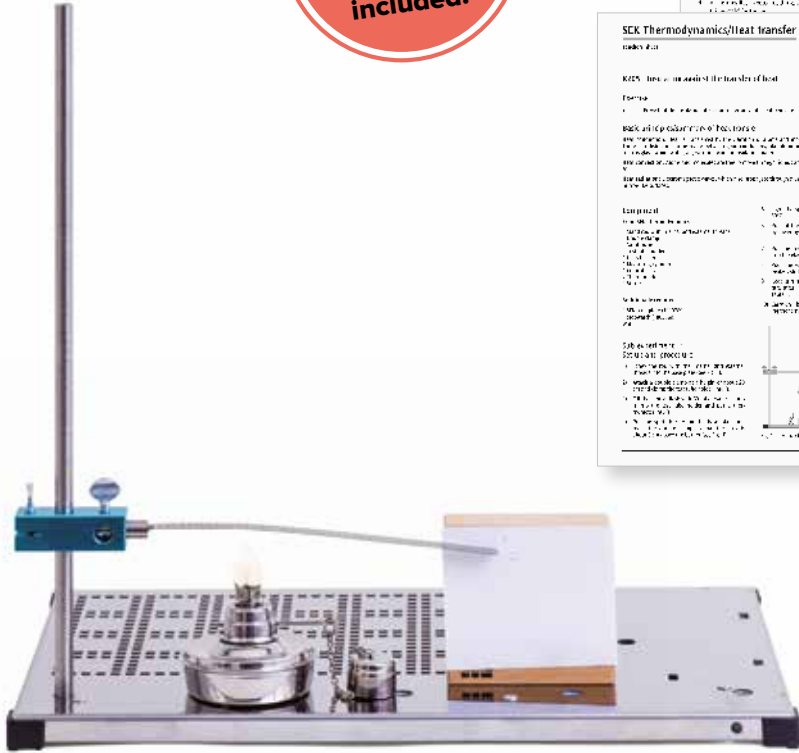

Investigation of a bi-metallic strip

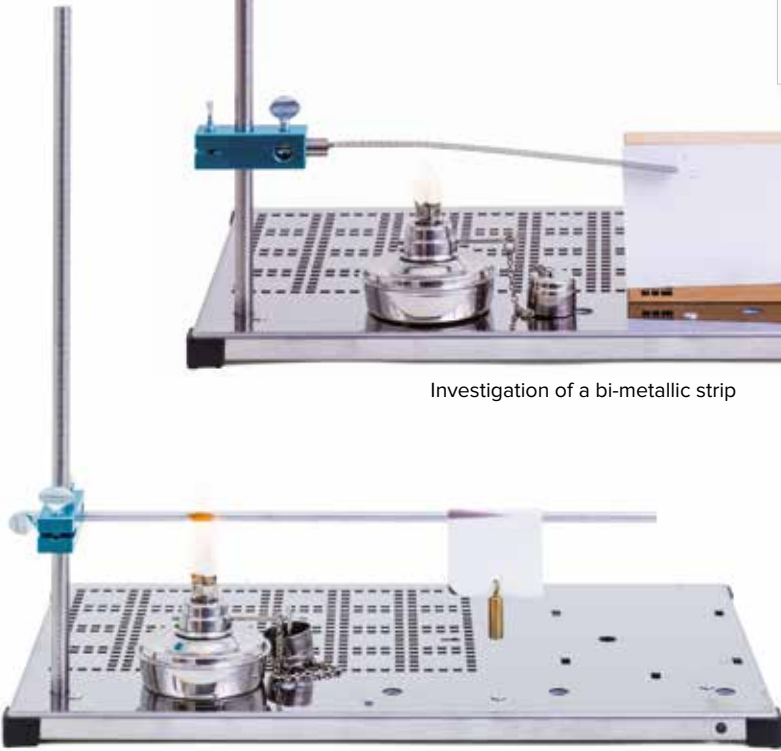

Heat transfer in solid bodies



Specific heat capacity of metals

Thermodynamics/K205 Teachers' sheet SFK

Complete the following:

A Dewar vessel (Thermos flask) is designed to reduce all three kinds of heat transfer to a minimum (heat insulation).

- The mirrored surface of the double-walled glass vessel insulates against much of the heat radiation.
- The partial vacuum inside the double-walled vessel and the insulating layer between the vessel and its lid suppress most of the heat convection and conduction.
- The calorimeter is therefore insulated against losing heat to the surroundings.
- A Thermos flask keeps hot things hot and cold things cold for longer.

Give reasons for the following:

- Refrigerated trolleys (as used on trains) are painted white or silver.
Heat radiation is then reflected away instead of being absorbed.
- The handles of most saucepans are made of plastic.
The plastics used for such handles are poor conductors.
- Foam is good at insulating heat.
This is because the many bubbles of air prevent both conduction and convection of heat.

SEK Electricity and Magnetism

Set of equipment for carrying out 41 student experiments on electricity and magnetism. In a tough plastic box containing a foam insert with cut-outs for the equipment and featuring a transparent lid. Includes CD with experiment instructions. The experiments are set up and performed in a space saving fashion but are still clearly laid out on the SEK base plate (U8408035).

U8506000

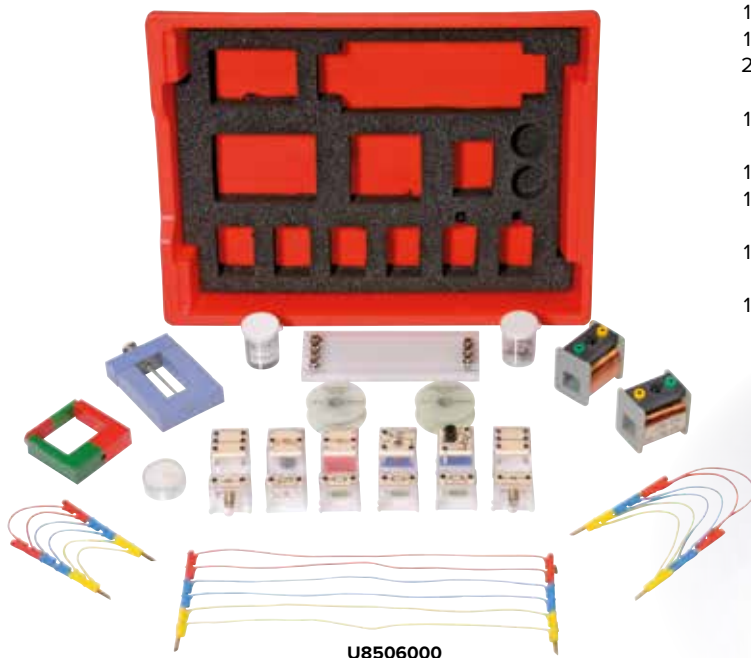

Contents:

- | | |
|--|--|
| 1 Set of experiment leads | 1 Resistor, 47 Ω
(plug-in component) |
| 1 Bar magnet,
65x16x5 mm approx. | 1 Resistor, 1 k Ω
(plug-in component) |
| 1 Horseshoe magnet, ALNICO,
flat | 1 NTC-resistor, 100 Ω
(plug-in component) |
| 1 Resistor board | 2 Lamp sockets, E10
(plug-in components) |
| 1 Transformer core, 20x20 mm | 2 Light bulbs, E10, 7 V |
| 1 Tightening screw | 1 Storage box with 1 set
of threads with washer,
2 threaded bushes, 2 thread-
ed pins, 2 Paper clips, 2 alu-
minium electrodes, constant
wire |
| 1 Coil, 200/400/600 windings | 50 g of iron filings |
| 1 Coil, 400/400/800 windings | 50 m of chrome/nickel wire,
0.2 mm |
| 2 Current branches
(plug-in components) | 50 m of iron wire, 0.2 mm |
| 1 Potentiometer, 100 Ω
(plug-in component) | 1 Tea candle |
| 1 Switch (plug-in component) | |
| 1 Capacitor, 4700 μ F
(plug-in component) | |
| 1 Capacitor, 10 μ F
(plug-in component) | |
| 1 Resistor, 33 Ω
(plug-in component) | |



Transformer under load

**Please ask for quantity discounts
on class sets for 8 pieces and more**

Includes 41 Experiments on the Subject of Electricity and Magnetism:

- Closed circuits
- Conductors and insulators
- Circuits with no branches
- Circuits with branches
- Current in a circuit with no branches
- Current in a circuit with branches
- Initial voltage and terminal voltages
- Voltage in a circuit with no branches
- Voltage in a circuit with branches
- Voltage dividers
- Ohm's law
- Temperature dependence of a resistor (iron wire)
- Current-voltage diagram for a light bulb
- Current-voltage diagram for a thermistor
- Law of resistance
- Resistance in a circuit with no branches
- Resistance in a circuit with branches
- Resistance and voltage in a circuit with no branches
- Resistance and current in a circuit with branches
- Voltage dividers with and without a load
- Voltage-time diagram for charging and discharging of a capacitor
- Current-time diagram for charging and discharging of a capacitor
- Relationship between charge and voltage
- Capacitor in the DC and AC circuit (response)
- Test bodies in a magnetic field
- Magnetic poles
- Magnetic field of a horseshoe magnet and a bar magnet
- Magnetic dipoles
- A coil used as a magnet
- Forces in the magnetic field of a coil
- Induction due to relative motion
- Induction due to changes in magnetic field
- Induction law
- Ohmic resistance in AC and DC circuits
- Capacitors in AC and DC circuits (resistance)
- Coils in AC and DC circuits
- How a transformer works
- Voltage and number of windings for a transformer with no load
- Transformer under load
- Transformer under heavy load
- Thermoelectricity

Equipment Electricity:

- U8506000 SEK Electricity and Magnetism**
- U8408035 SEK Base Plate**
- U8557330 Analogue Multimeter ESCOLA 30**
- U8498030-230 SEK Power Supply (230 V, 50/60 Hz)**
or
- U8498030-115 SEK Power Supply (115 V, 50/60 Hz)**



U8498030-230
U8498030-115

SEK Power Supply

AC/DC power supply for SEK electricity and magnetism kit (U8506000). Housing with attachment hooks for clamping into the SEK base plate (U8408035).

Voltages: 1.5/ 3.0/ 4.5/ 6.0 V AC/DC

SEK Power Supply (230 V, 50/60 Hz)

U8498030-230

SEK Power Supply (115 V, 50/60 Hz)

U8498030-115

CD-ROM
containing all
different sets of
instructions is
included!

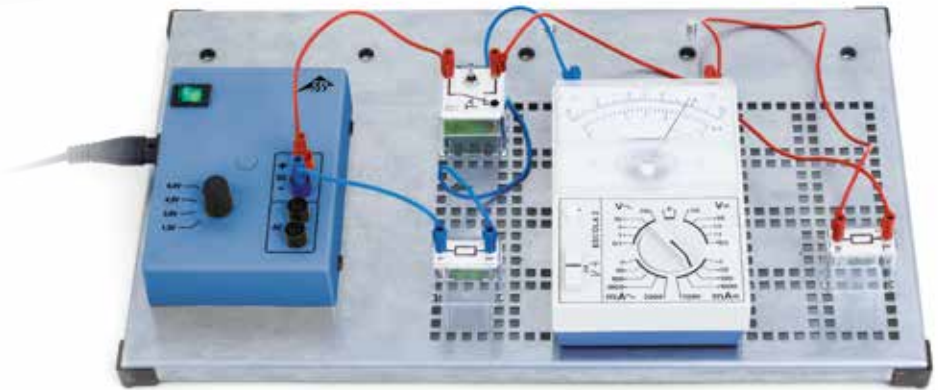

Electric current in circuits with no branches

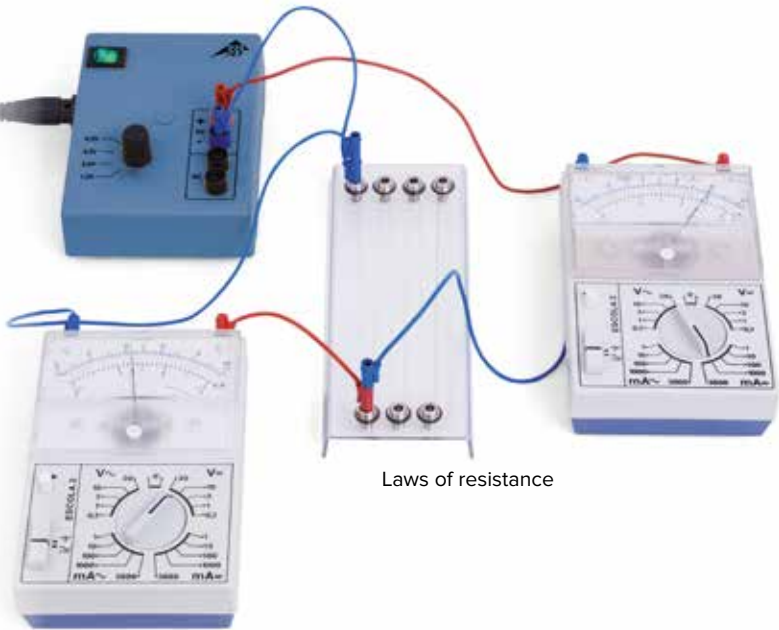

Laws of resistance

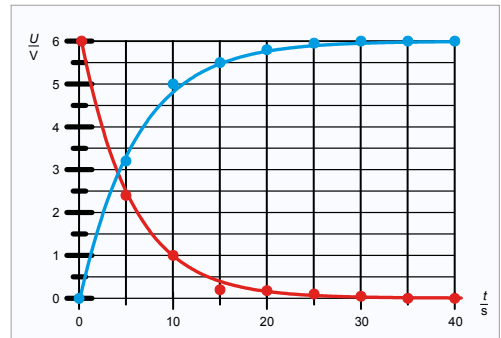

Capacitor: charging (blue) and discharging (red)

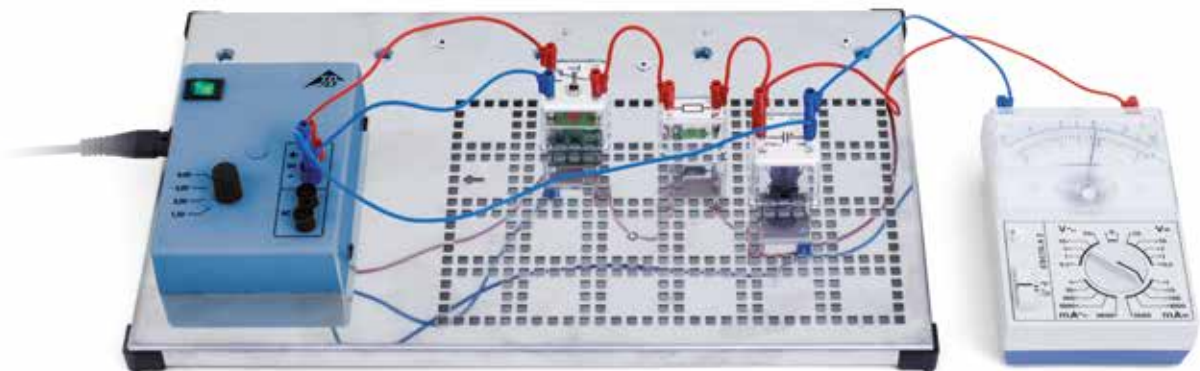

Charging and discharging of a capacitor (voltage)

SEK Optics

Set of equipment for carrying out 38 student experiments on ray optics. In a tough plastic box containing a foam insert with cut-outs for the equipment and featuring a transparent lid. Includes CD with experiment instructions. The experiments are designed to be compact but still easy to see when set up and carried out on the supplied optical bench or the SEK base plate (U8408035). In both cases, the optical components are attached in non-slip fashion by magnets. Supplied overlays designate where the components are to be placed.

SEK Optics (230 V, 50/60 Hz)

U8503000-230

SEK Optics (115 V, 50/60 Hz)

U8503000-115

Contents:

1 Optical bench	1 Semi-circular body
1 Optical lamp, 5 V, 2 W	1 Diverging lens, flat model
1 Plug-in power supply, 100 – 240 V, 50/60 Hz	1 Converging lens, flat model
4 Tea candles	1 Right-angled prism
1 Plastic container	1 Rectangular block
1 Slide holder, magnetic	1 Objects for casting shadows
1 F-shaped slide	1 Flexible mirror, magnetic
1 Slide with triple and quintuple slits	1 Projection screen/ Experimenttable
1 Slide with single slit	2 Lenses, $f = +50$ mm
1 Object for use as an image	1 Lens, $f = +100$ mm
1 Colour filter, red	1 Lens, $f = +300$ mm
1 Colour filter, blue	1 Lens, $f = -100$ mm
1 Acrylic block with holder	1 Set of overlays



U8503000-230
U8503000-115

CD-ROM
containing all
different sets of
instructions is
included!

Includes 38 Experiments on the Subject of Optics:

- Propagation of light, light beams and rays
 - Transparency
 - Light and shadow
 - Umbra and penumbra
 - Reflection from a plane mirror
 - Concentration of light by a concave mirror
 - Reflection and path of light for a concave mirror
 - Reflection and path of light for a convex mirror
 - Characteristics of the image from a plane mirror
 - When light passes from air into glass / Determination of refractive index
 - When light passes from glass into air / Determination of refractive index
 - Determination of critical angle for total internal reflection (glass to air)
 - Ray diagrams for a rectangular glass block, laws
 - Ray diagrams for a glass prism
 - Total internal reflection inside a prism
 - Path of light through a converging lens
 - Determination of focal length for a converging lens
 - Ray diagrams with parallel ray and ray through centre of lens (converging lens)
 - Path of light through a diverging lens
 - Determination of focal length for a diverging lens
 - Ray diagrams with parallel ray and ray through centre of lens (converging lens)
 - Path of light through a system of lenses
 - Image properties (converging lens)
 - Image magnification and the lens equation
 - Image aberrations with converging lenses
 - Formation of images in the eye
 - Short-sightedness
 - Long-sightedness
 - Astigmatism
 - Cameras
 - Slide projectors
 - Microscopes
 - Galileo telescope
 - Kepler's telescope
 - Terrestrial telescope
 - Separation of light into a spectrum
 - Recomposition of spectral colours
 - Additive mixing of colours, complementary colours
- Equipment Optics:
U8503000-230 SEK Optics (230 V, 50/60 Hz)
or
U8503000-115 SEK Optics (115 V, 50/60 Hz)



Reflection and path of light for a convex mirror

Please ask for quantity discounts on class sets for 8 pieces and more

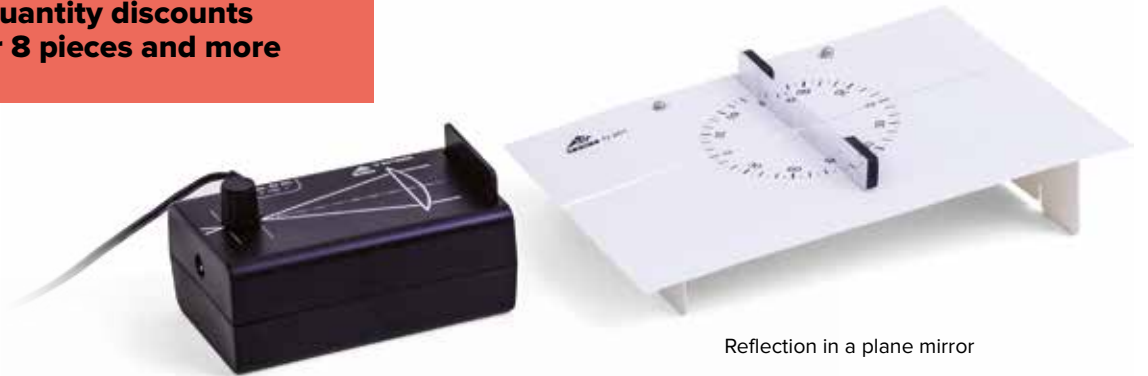

Reflection in a plane mirror

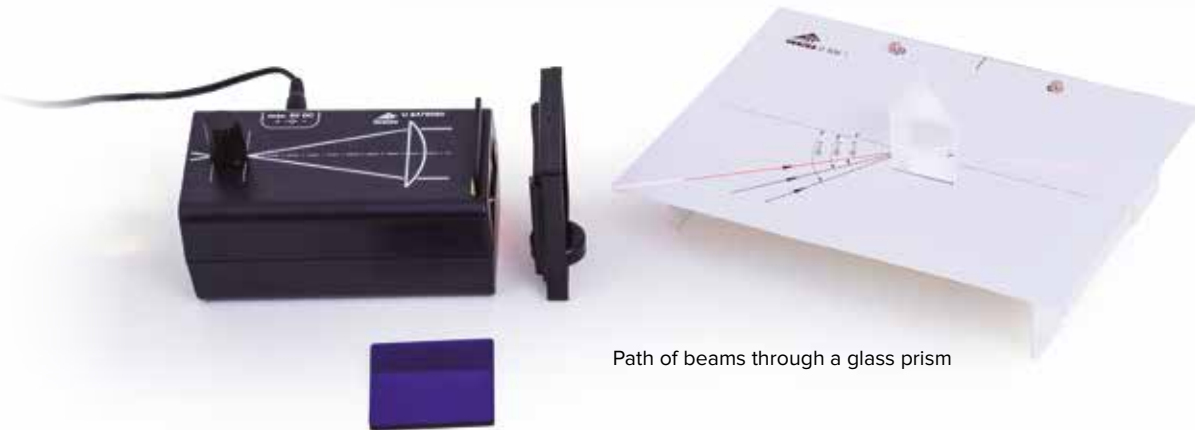

Path of beams through a glass prism



Model microscope

new

SEK Mechanical Oscillations and Waves

Large equipment set for carrying out 23 fundamental experiments on the properties of mechanical oscillations and waves. Stored in a tough Gratnell tray with foam inlay featuring recesses moulded to the shape of the apparatus and covered by a transparent lid. Includes CD with experiment instructions.

SEK Mechanical Oscillations and Waves (230 V, 50/60 Hz)

U61020-230

SEK Mechanical Oscillations and Waves (115 V, 50/60 Hz)

U61020-115

Contents:

- | | |
|------------------------------------|---|
| 1 MEC control unit | 2 Stand rods with external and internal threads |
| 1 Plug-in power supply | 2 Double clamps |
| 2 Dynamic force sensors | 1 Magnetic hooks |
| 1 Eccentric axle motor | 1 Induction coil |
| 1 Stopwatch | 1 Bar magnet |
| 4 Coil springs | 1 Rubber cord |
| 1 Set of 10 weights, 50 g | 1 Roll of twine |
| 1 Base plate | 1 Thread eyelet |
| 1 Cross-strut | 1 Squirrel cage ring |
| 2 Stand rods with external threads | 1 Ruler |
| | 2 BNC cable, 1 m |
| | 1 BNC/4-mm cable |

Please ask for quantity discounts on class sets for 8 pieces and more



U61020-230
U61020-115

Includes Instruction for 23 Experiments on Mechanical Oscillations and Waves:

- Determining spring constants (2x)
- Oscillations of a spring pendulum *
- Oscillations of two “identical” spring pendulums * / **
- In-phase and 180° out-of-phase oscillations of two “identical” spring pendulums * / **
- Excitation of a motionless spring pendulum by a moving one * / **
- Superposition of the oscillations of two spring pendulums * / **
- Spring pendulums connected in line * / **
- Spring pendulums connected parallel to one another * / **
- Intrinsic oscillation of a spring pendulum *
- Types of oscillation for a coil spring pendulum *
- String pendulums (2x)
- Seconds pendulums
- Galileo’s interrupted pendulum
- Damped oscillations of string pendulums (2x) *
- Standing waves along a rope (2x) *
- Reflection of waves along a rope *
- Speed of propagation of waves along a rope (2x) *
- Oscillation of strings *

Equipment Mechanical Oscillations and Waves:
U61020-230 SEK Mechanical Oscillations and Waves (230 V, 50/60 Hz)
 or
U61020-115 SEK Mechanical Oscillations and Waves (115 V, 50/60 Hz)

Dual-channel Oscilloscope, e.g.
U112491 USB Oscilloscope 2x50 MHz
 (for experiments marked *)

U8557330 Analogue Multimeter ESCOLA 30
 (for experiments marked **)

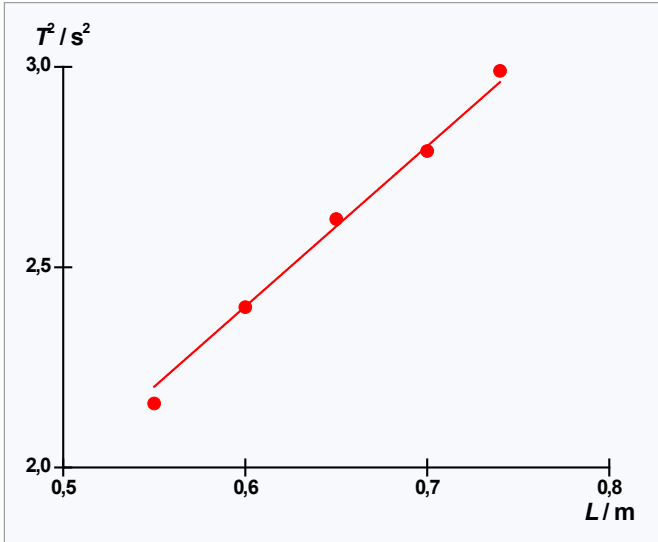

Squares of the period as a function of the length of the pendulum

CD-ROM
containing all
different sets of
instructions is
included!

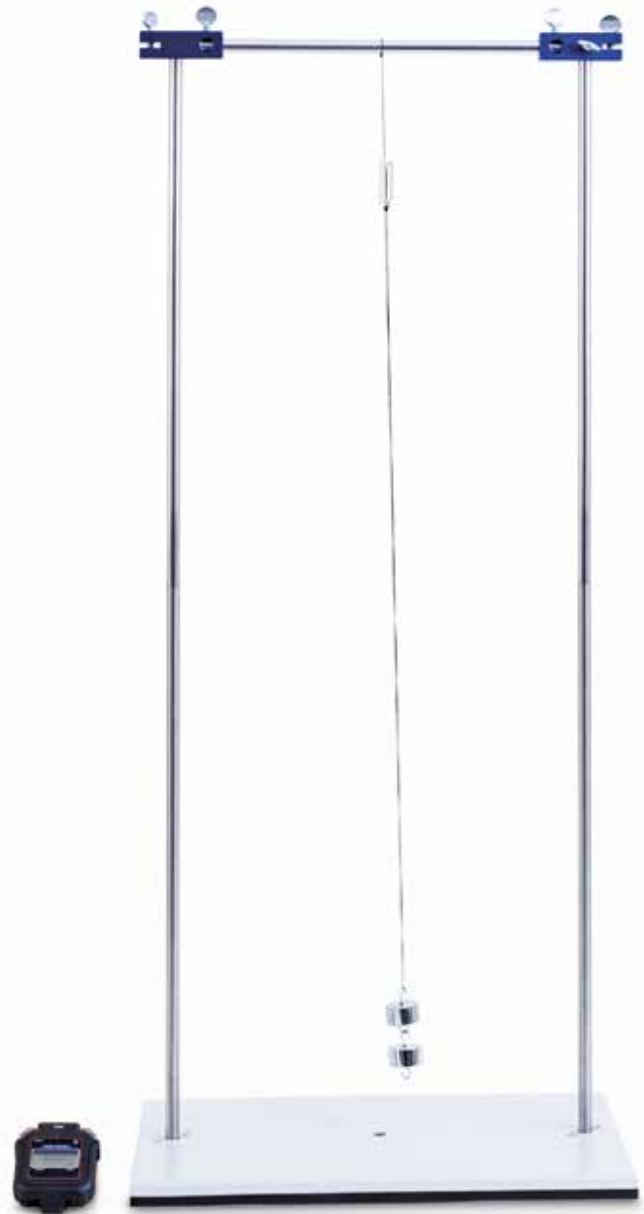

String pendulum

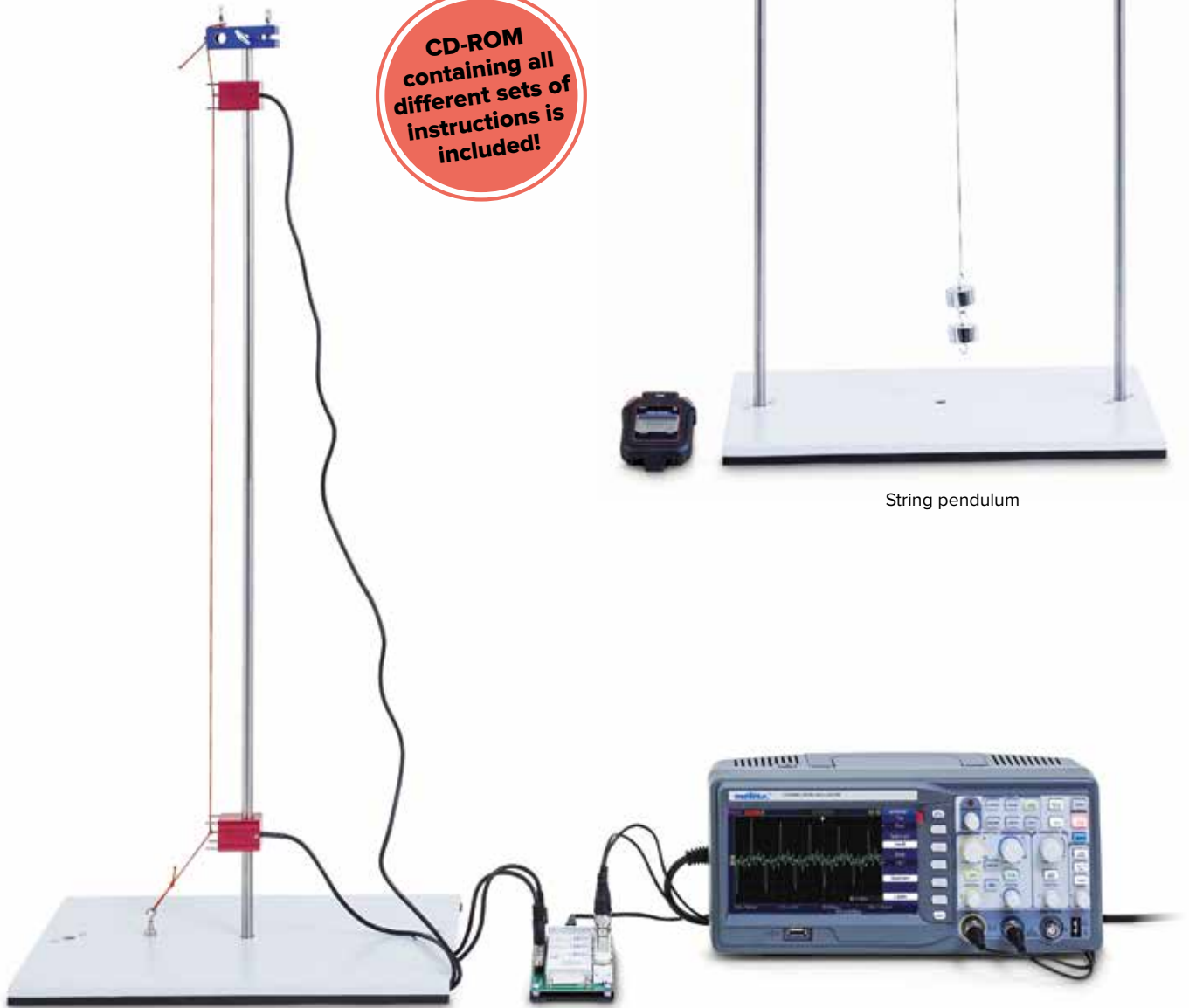

Reflection of waves along a rope

new

SEK – Ultrasonic Waves

Large equipment set incorporating 30 student experiments for demonstrating the fundamental properties of waves using the example of 40 kHz ultrasonic waves. Stored in a tough Grattnell tray with foam inlay featuring recesses moulded to the shape of the apparatus and covered by a transparent lid. Includes CD with experiment instructions. Includes two ultrasonic transmitters, a rod-shaped microphonic sensor for recording and analysing oscillations using a standard oscilloscope and an ultrasonic pen for recording wave fronts along the desktop in the form of lines of the same phase (isophases). Many of the experiments can also be carried out without using an oscilloscope. In order to measure ultrasonic amplitudes, it is sufficient in many cases to use an analogue voltmeter for alternating current if it has a wide enough frequency range.

Contents:

- 1 Ultrasonic control unit
- 2 Ultrasonic transmitters, 40 kHz
- 1 Ultrasonic pen
- 1 Holder for ultrasonic pen
- 1 Holder base for ultrasonic pen
- 1 Microphone probe
- 2 Beam splitters
- 3 Clamps for beam splitters
- 1 Fresnel zone plate
- 1 Concave mirrors
- 2 Side pieces for double slit/reflectors
- 1 Centre post for double slit
- 1 Clap for double slit
- 1 Ultrasonic absorber
- 2 BNC cables, 1 m
- 1 Cable, BNC/4-mm
- 1 Plug-in power supply

SEK – Ultrasonic Waves (230 V, 50/60 Hz)

U61010-230

SEK – Ultrasonic Waves (115 V, 50/60 Hz)

U61010-115

CD-ROM
containing all
different sets of
instructions is
included!



U61010-230
U61010-115

**Please ask for quantity discounts
on class sets for 8 pieces and more**

Includes Instruction for 30 Experiments on Ultrasonic Waves

- Display of sound oscillations on an oscilloscope *
- Relationship between oscillations and waves *
- Comparison of oscillations at two points along a wave *
- Analysis of phase relationships using an ultrasonic "pen" *
- Determination of wavelength and velocity of sound
- How velocity of sound depends on temperature
- Transmission characteristic of ultrasonic transmitters **
- Resonance curve for ultrasonic transducers *
- Transmission and reflection of ultrasonic waves **
- Absorption of ultrasonic waves **
- Superimposition of sinusoidal oscillations *
- Constructive and destructive reinforcement when sinusoidal oscillations are superimposed *
- Recording of wave fronts using ultrasonic pen
- Generation and detection of straight wave fronts
- Diffraction of ultrasonic waves by an edge
- Diffraction of ultrasonic waves by a single slit
- Interference between two beams **
- Law of reciprocity for interference between two beams **
- Diffraction by a double slit **
- Phase relationships for diffraction by a double slit I *
- Phase relationships for diffraction by a double slit II **
- Formation of images by a spherical concave mirror **
- Plotting of Fresnel zones **
- Formation of images by a Fresnel zone plate **
- Interference of ultrasonic waves by Lloyd's mirror **
- Design of a simple interferometer **
- Design of a Michelson interferometer **
- Elimination of interference by interrupting the path *
- Generation of standing ultrasonic waves **
- Beats in ultrasonic waves *
- Doppler effect in ultrasonic waves

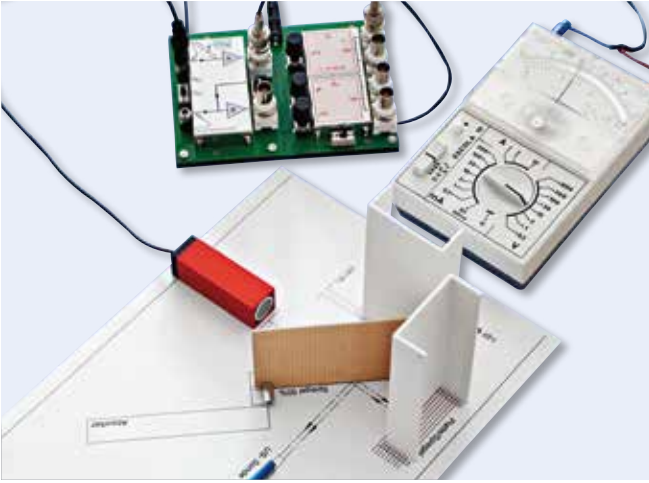

Michelson Interferometer

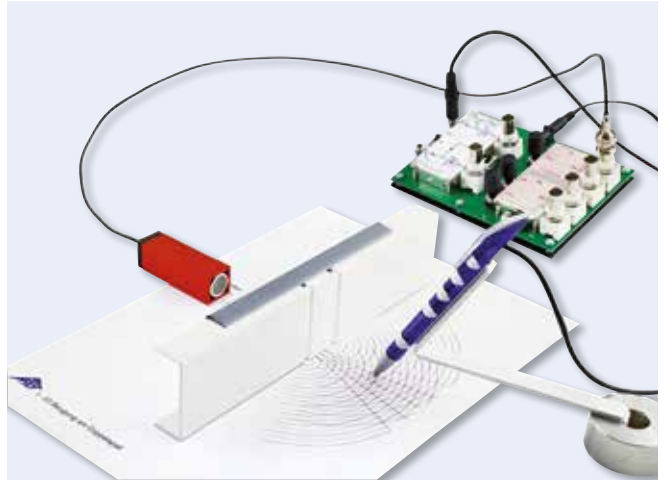

Diffraction by a double slit

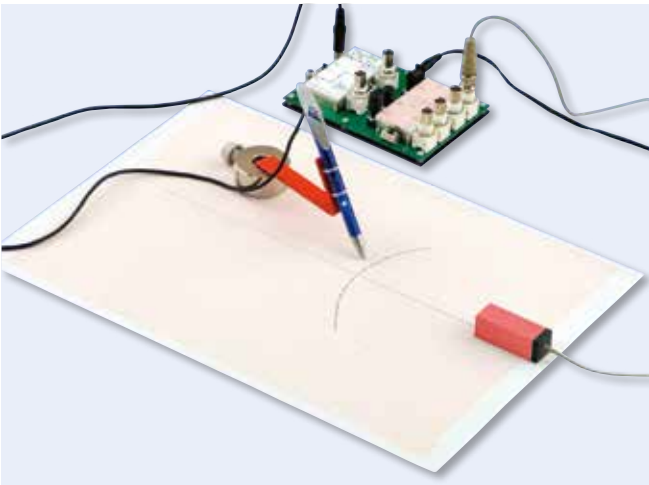

Recording of wave front

Equipment Ultrasonic Waves:

U61010-230 SEK Ultrasonic Waves (230 V, 50/60 Hz)
 or
U61010-115 SEK Ultrasonic Waves (115 V, 50/60 Hz)

Dual-channel Oscilloscope, e.g.
U112491 USB Oscilloscope 2x50 MHz
 (for experiments marked *)

U8557330 Analogue Multimeter ESCOLA 30
 (for experiments marked **)

Additionally required when using an analogue voltmeter which is unsuitable for measuring alternating voltages of frequencies up to 40 kHz:

U8557390 Ultrasonic Adapter Lead

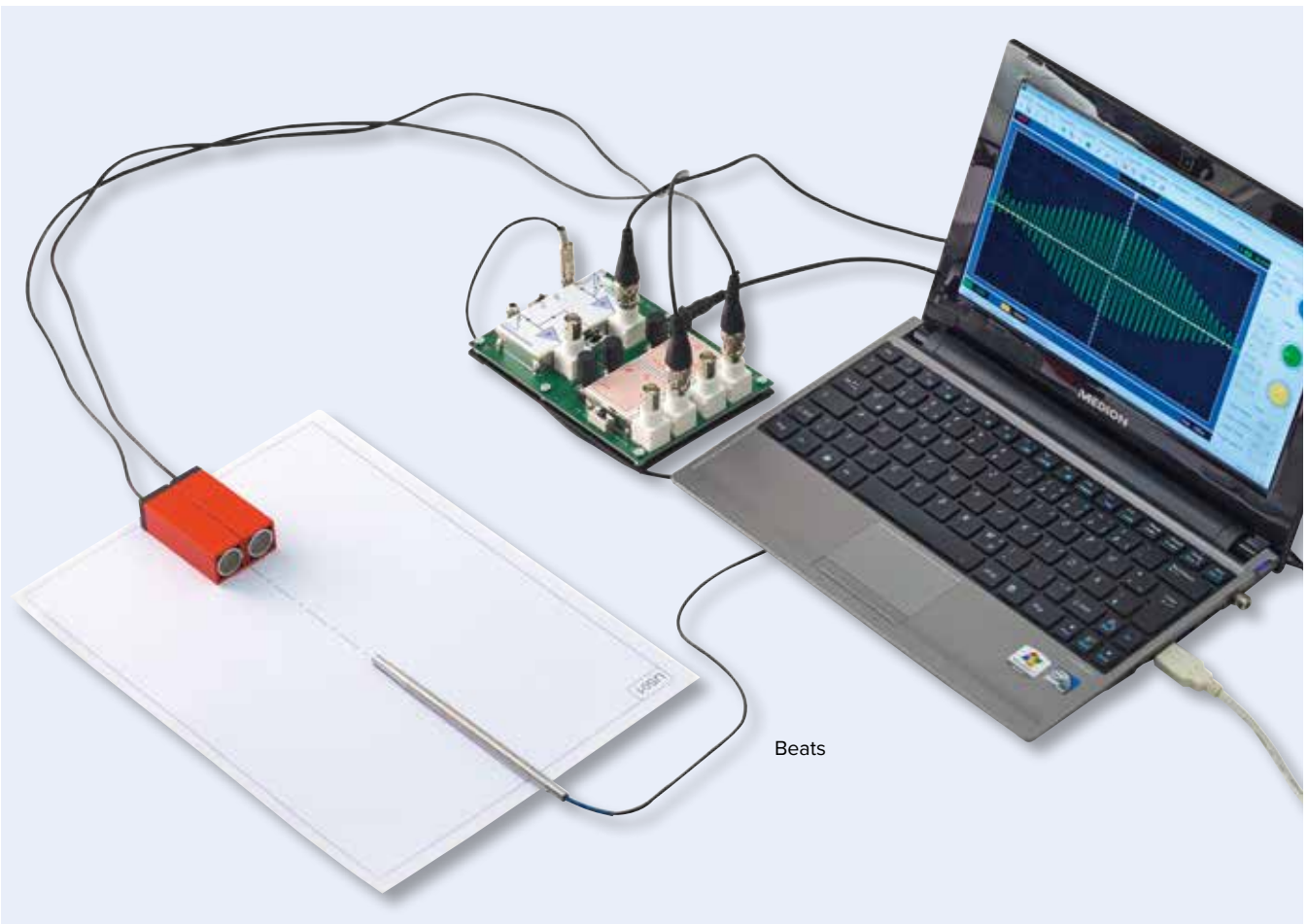

Beats

SEK Radioactivity

Set of apparatus for carrying out 10 basic student experiments on radioactivity. In a robust plastic box with foam inserts moulded to the shapes of the items and a transparent lid. Includes a CD with instructions for the experiments. The experiments are designed to occupy as little space as possible on the supplied base plate, while remaining clear and easy to perform. To determine the count rates, it is recommended that a GAMMASCOUT Geiger counter (U111511) be used (not included).

U8504000

Contents:

- | | |
|---|--------------------------------------|
| 1 Base plate 340x250 mm | 2 Aluminium plates, 0.5 mm |
| 3 Work templates | 1 Aluminium plate, 1 mm |
| 1 Holder for sources and deflecting magnet | 1 Lead plate, 2 mm, in plastic cover |
| 1 Deflecting magnet | |
| 1 Thorium irradiation module (weld filler wire) | |



Please ask for quantity discounts on class sets for 8 pieces and more

Includes 10 Experiments on the Subject of Radioactivity:

- Determining background radiation
- Determining pulse rates for various radioactive preparations
- Statistical distribution of counter pulses
- Determination of equivalent dose for various radioactive preparations
- Penetrative capacity and range of radiation
- Deflection of alpha and beta radiation by a magnetic field*
- Absorption of alpha rays*
- Absorption of beta rays*
- Absorption of gamma rays*
- Inverse square law

Equipment Radioactivity:

U8504000 SEK Radioactivity

U111511 Geiger Counter GAMMASCOUT

*additionally required:

U8483115 Radiation Cartridge ^{226}Ra 4 kBq



Deflection of alpha and beta radiation by a magnetic field

Geiger Counter

Versatile, easy to use and compact precision instrument for measuring α -, β - and γ -radiation. With filter selection switch at the front of the Geiger-Müller counter tube for filtering out types of radiation (γ/β , $\gamma/\alpha/\beta$ or γ only), large display and integrated USB interface. Including USB cable, Windows software, and operating instructions. The following functions and operating modes are available for measurement:

- Standard mode for displaying the current radiation level. Display of the equivalent dose as a numerical value and a bar chart and display of the time until a selected cumulative dose limit is reached (default 5 $\mu\text{Sv/h}$). Also equipped with variable acoustic and optical warning threshold signal and display of average radiation from previous day.
- Pulse counting either permanent or with variable gate time. Gate time adjustable in seconds, minute or hours. Additional optional acoustic count indication.
- Count rate measurement. The pulses registered are measured successively and converted into a count rate (number of pulses per second).
- Integrated display of date and time for correct recording of measured radiation.
- The number of pulses registered is stored in the internal memory. This facilitates recording e.g. of weekly values for up to 10 years.
- Computer docking station. The software enables the measured data to be evaluated and processed on an MS-Windows PC.

Radiation types: α from 4 MeV, β from 0.2 MeV, γ from 0.02 MeV

Measured variables: equivalent dose in Sv/h, mSv/h, $\mu\text{Sv/h}$
pulses/s, pulses/variable time interval

Display: LCD, 4 digit, numerical with display of measured variable, quasi analogue bar chart, operating mode indicators

Radiation detector: End window Geiger-Müller counter tube, stainless steel housing with neon-halogen filling

Measuring length: 38.1 mm

Measuring diameter: 9.1 mm

Mica window: 1.5 – 2 mg/cm²

Gamma sensitivity: 114 pulses/min for ⁶⁰Co radiation = 1 $\mu\text{Sv/h}$ in background radiation energy band

Background rate: 10 pulses per minute approx.

Internal memory: 2 kilobytes

Battery life: 3 years approx.

Dimensions: 163x72x30 mm³ approx.

Weight: 155 g approx.

U111511



U111511

SEK Radioactivity



Absorption of beta radiation from the thorium cartridge

CD-ROM containing all different sets of instructions is included!



U8483115

Note:

Due to the special delivery conditions applying to radiation cartridges, transport costs are higher than usual.

Radiation Cartridge, ²²⁶Ra, 4 kBq

Regulation-exempt radiation source with brass container for shielding. Radium sulphate rolled in gold foil and sealed at one end of a stainless steel cartridge.

Activity: 4 kBq

Weight: 400 g approx.

U8483115

Student Experiments

new

SEK Solar Energy

Large equipment set for carrying out 23 fundamental experiments on solar energy. The basic parameters and properties of solar modules and the aspects which affect their energy efficiency can all be demonstrated by experiment. Contained in a rugged metal case including foam inlay with recesses in the shape of the apparatus. The system allows you to assemble experiments easily and in a compact set-up on or in the lid of the kit's carry case. Includes CD with experiment instructions.

SEK Solar Energy (230 V, 50/60 Hz)

U8498301-230

SEK Solar Energy (115 V, 50/60 Hz)

U8498301-115

Contents:

1 Halogen spotlight	1 Jumper
2 Solar modules	1 Set of experiment leads
2 Digital multimeters	1 Cross piece
1 Lux meter	1 Support brace
1 Digital thermometer	1 Set of items for covering modules
1 Terminal board with resistor cascade	1 Case
1 Power adjuster	

CD-ROM containing all different sets of instructions is included!



U8498301-230
U8498301-115

Includes instruction for 16 Experiments on Solar Energy:

- Illuminance of various light sources
- Parameters affecting the power generated by a solar module
- Shading of solar modules connected in series
- Effect of shading on the terminal voltage of a solar module
- Effect of illuminance on the open-circuit voltage and short-circuit current for a solar module
- Effect of angle of incidence on the open-circuit voltage and short-circuit current for a solar module
- Open-circuit voltage and short-circuit current for solar modules connected in series and in parallel
- Current-voltage characteristic for a solar module
- Current-voltage characteristic for solar modules in series
- Current-voltage characteristic for solar modules in parallel
- Optimum load resistance when the angle of incidence changes
- How the open-circuit voltage and short-circuit current for a solar module depend on temperature
- How power output from solar modules depends on temperature
- Voltage-current characteristic for illuminated and non-illuminated solar modules *
- Setting up a stand-alone power supply network **
- Energy conversion ***

Equipment Solar Energy:

U8498301-230 SEK Solar Energy (230 V, 50/60 Hz)
or
U8498301-115 SEK Solar Energy (115 V, 50/60 Hz)

U33020-230 DC Power Supply 0-20 V (230 V, 50/60 Hz)
or
U33020-115 DC Power Supply 0-20 V (115 V, 50/60 Hz)
(for experiments marked *)

U8498303 Coulombmeter with Rechargeable Battery
U11902 Digital Stopwatch
(for experiments marked **)

U8498304 Geared Motor with Pulley
U300131 Set of Weights 1 g to 500 g, slotted with Holder
U8613283 Experiment Cord
U11902 Digital Stopwatch
(for experiments marked ***)

new

Coulombmeter with Rechargeable Battery

Coulombmeter for measuring the flow of current when storing energy in a rechargeable battery. Charge or consumption can be displayed by means of a voltmeter. Depending on the measuring range selected, 1 V on the voltmeter corresponds to either 0.1, 1 or 10 ampere seconds (As).

- Measuring ranges: 1/10/100 As (max. measurable charge ± 499 As)
- Power supply: 9 V rechargeable battery via DC co-axial power socket
- Load current: max. 500 mA
- Charging current for battery: max. 50 mA
- External power source: Solar panel or DC power supply (max. 12 V DC) with current limiting to 50 mA when there is no load on the coulombmeter
- Connectors: 4-mm safety sockets
- Dimensions: 105x75x45 mm³ approx.
- Weight: 200 g including rechargeable battery and housing

U8498303



U8498303

new

Geared Motor with Pulley

The geared motor with string pulley is used in conjunction with the Solar Energy Student Experiment Kit as a load for demonstrating conversion of energy. The motor is mounted on a base plate and has a pulley attached for a string. Power is supplied via 4-mm safety sockets. Weights of up to approximately 1 kg can be lifted.

- Power supply: max. 12 V DC
- Load current: max. 50 mA
- Torque: 0.41 Nm
- Speed: 76.1 rpm with no load
- Connectors: 4-mm safety sockets
- Dimensions: 105x75x45 mm³ approx.
- Weight: 220 g approx.

U8498304



U8498304

Please ask for quantity discounts on class sets for 8 pieces and more

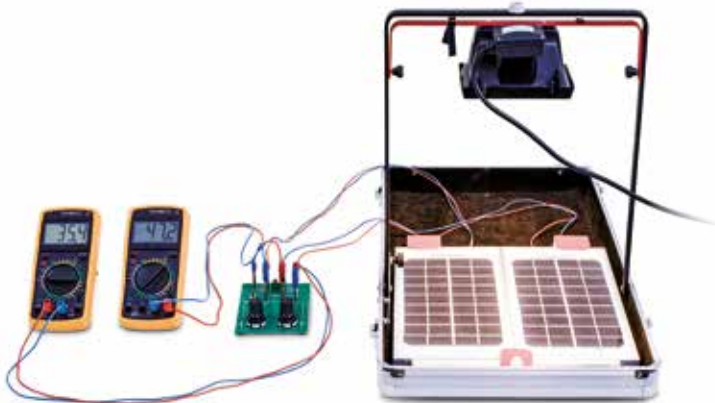

Current-voltage characteristic for solar modules in series



Optimum load resistance when the angle of incidence changes



How power output from solar modules depends on temperature

Kröncke Optical System for Student Exercises

The Kröncke optical system provides robust reliability that has been tried and tested for decades and offers all the precision needed for student exercises and practical courses in numerous experiments on ray and wave optics. The experiments are carried out in traditional fashion using the white light of an incandescent lamp, the filament of which can be projected through an adjustable slit to observe interference in particular.

All optical components are mounted in diaphragms with no stems and can easily be adjusted vertically and with precision into the optical light path when mounted on optical riders. Optical riders can freely move on the U-profile rail of an optical bench and can be attached with a minimum of force.

Basic Set for Kröncke Optical System

Contents:

- 1 Optical lamp
- 1 Transformer 12 V, 25 VA
- 1 Optical bench, 1000 mm
- 6 Optical slides
- 2 Clamps
- 2 Converging lenses, $f = 50$ mm
- 2 Converging lenses, $f = 100$ mm
- 2 Converging lenses, $f = 150$ mm
- 1 Converging lens, $f = 300$ mm
- 1 Converging lens, $f = 500$ mm
- 1 Diverging lens, $f = -100$ mm
- 1 Diverging lens, $f = -500$ mm
- 1 Diaphragm with 1 slit
- 1 Diaphragm with 3 slits
- 1 Photograph in slide frame
- 1 Transparent screen
- 1 White screen
- 1 Set of 4 colour filters
- 1 Ruler, 15 mm
- 1 Set of holes arranged to form the number "1"
- 1 Pinhole aperture, $d = 1$ mm
- 1 Pinhole aperture, $d = 6$ mm

Please ask for quantity discounts on class sets for 8 pieces and more



Basic Set for Kröncke Optical System (230 V, 50/60 Hz)

U8477120-230

Basic Set for Kröncke Optical System (115 V, 50/60 Hz)

U8477120-115

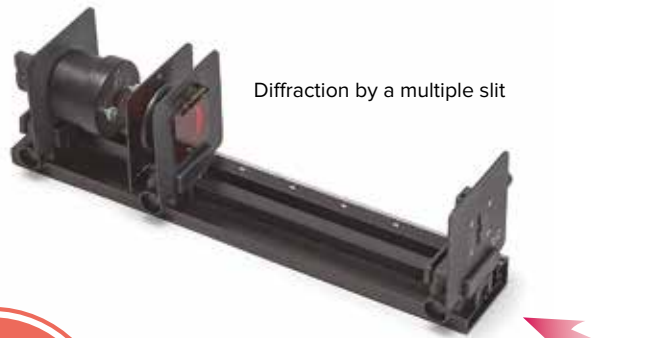

Diffraction by a multiple slit

2m

Includes 12 Experiments on the Subject of Ray Optics:

- Pinhole camera
- Imaging with converging lenses
- Image aberrations
- Images in the eye (eye model)
- Correction of vision
- Magnifying glasses
- Microscopes
- Astronomical telescopes
- Terrestrial telescopes
- Slide projectors

CD-ROM containing all different sets of instructions is included!

Equipment Ray Optics:

U8477120-230 Basic Set for Kröncke Optical System (230 V, 50/60 Hz) or

U8477120-115 Basic Set for Kröncke Optical System (115 V, 50/60 Hz)



Slide projector



Visibility of polarised light in turbid water

Includes 3 Experiments on the Subject of Polarisation:

- Polarisation of transverse waves
- Polariser and analyser
- Visibility of polarised light in turbid water
- Double refraction
- Rotation of planes of polarisation by a sugar solution

Equipment Polarisation:

- U8477120-230** Basic Set for Kröncke Optical System (230 V, 50/60 Hz) or
- U8477120-115** Basic Set for Kröncke Optical System (115 V, 50/60 Hz)
- U8477140** Supplementary Set for Polarisation



U8477140

Supplementary Set for Polarisation

Supplementary set to the Kröncke optics basic set (U8477120-230 or U8477120-115) for carrying out student experiments on the polarisation of light waves.

Contents:

- 1 Pair of polarising filters
- 1 Pinhole aperture, 10 mm
- 1 Rectangular cuvette

U8477140



U8477130

Supplementary Set for Interference

Supplementary set to the Kröncke optics basic set (U8477120-230 or U8477120-115) for carrying out student experiments on the interference of light waves.

Contents:

- 1 Optical bench, 500 mm
- 1 Adjustable slit
- 1 Diaphragm with 9 circular discs
- 1 Diaphragm with 9 circular holes
- 1 Diaphragm with 3 individual slits and 1 double slit
- 1 Diaphragm with 4 multiple slits and grating
- 1 Diaphragm with 3 ruled gratings
- 1 Micrometer screw
- 1 Fresnel mirror

U8477130

Includes 10 Experiments on the Subject of Interferences:

- Fresnel mirror
- Diffraction by small openings and plates
- Diffraction by an air gap
- Diffraction by the wire
- Diffraction by multiple slits
- Diffraction by the grating
- Optical resolution
- Determining the wavelength of light

Equipment Interference:

- U8477120-230** Basic Set for Kröncke Optical System (230 V, 50/60 Hz) or
- U8477120-115** Basic Set for Kröncke Optical System (115 V, 50/60 Hz)
- U8477130** Supplementary Set for Interference

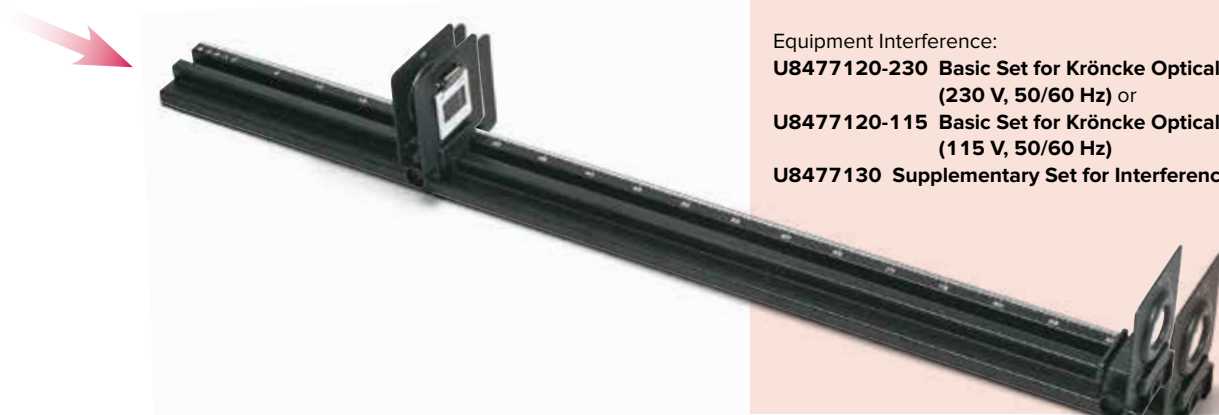

Experiment Topics:

- Displacement-time graphs
- Linear gradients
- Velocity

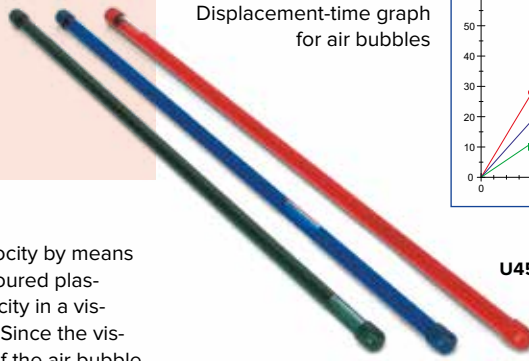

Displacement-time graph for air bubbles

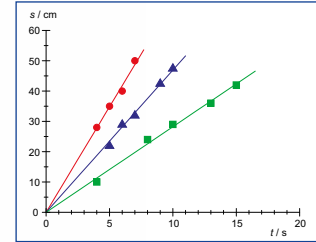

U45060

Constant Velocity Student Kit, 3 Tubes

Set of equipment for investigating the concept of velocity by means of student experiments. Consisting of three small coloured plastic tubes in which an air bubble rises at constant velocity in a viscous liquid, provided the tubes are aligned vertically. Since the viscosities differ, the velocities also differ. The position of the air bubble is plotted against time. The three different resulting straight lines lead to a definition of velocity.

Length: 500 mm approx.
Diameter: 13 mm approx.

U45060

Additionally required:

- U40801 Mechanical Stop Watch, 15 min
- U10073 Pocket Measuring Tape, 2 m

! Advantage

- It is possible to demonstrate both positive and negative velocities.

Constant Velocity Student Kit, 4 Tubes

Set of equipment for investigating the concept of velocity by means of student experiments. It consists of one transparent and three coloured plastic tubes. In the coloured tubes an air bubble rises with constant speed in a viscous fluid as soon as the tube is held vertical. Since the viscosities inside the tubes differ, the velocities with which the bubbles rise in each of them are also different. The transparent tube also contains a plastic ball and a metal ball which sink down the tube thus demonstrating negative velocities. The positions of the bubble or the balls are plotted on a graph. The gradients of the various resulting straight lines lead to a definition of velocity.

Length: 830 mm approx.
Diameter: 13 mm approx.

U45060-4

Additionally required:

- U40801 Mechanical Stop Watch, 15 min
- U10073 Pocket Measuring Tape, 2 m

Displacement-time graph for air bubbles and the balls

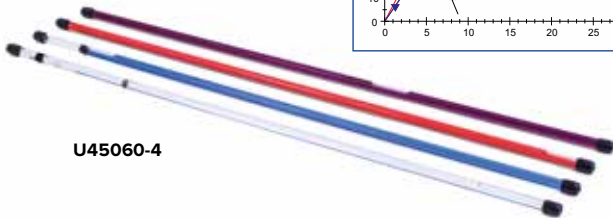
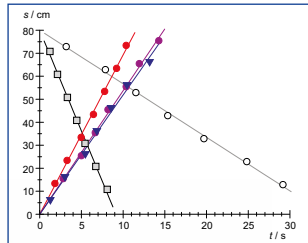

U45060-4

Experiment Topics:

- Determining mass of evacuated air and density of air
- Effect of air pressure on a slightly inflated hot-air balloon and on a suction cap
- Lowering of the boiling point of liquids at decreased air pressure

Vacuum Student Kit

Set of equipment for introducing the fundamentals of vacuum physics by means of student experiments.

Contents:

- 1 Experiment plate with washer
- 1 Vacuum bell jar
- 1 Beaker
- 1 Pressure hose with check valve
- 1 Pressure hose with T-connector and check valve
- 1 Simple hand pump in storage container
- 1 Suction cap
- 2 Balloons

U45052

Additionally recommended:

- U42048-230 Electronic Scales Scout Pro 200 g

Effect of air pressure on a slightly inflated balloon

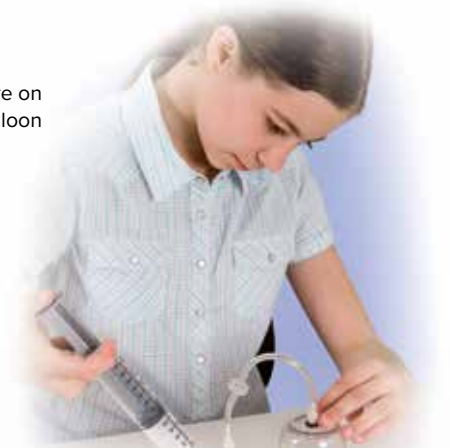

U45052

Experiment Topics:

Colours:

- Coloured light and coloured objects
- Mixture of colours

Shadows:

- Casting shadows
- Coloured shadows

Reflection:

- Reflection from a plane mirror
- Reflected images, image reversal
- Multiple reflections from a mirror
- Reflection from a concave mirror (focal point and spherical aberration)
- Reflection from a parabolic mirror
- Reflection from a convex mirror

Refraction:

- Determining refractive index with a semi-circular object
- Determining refractive index with a parallel block
- Angle of minimum deflection for a prism
- Total internal reflection in a semi-circular object
- Total internal reflection in a prism
- Focal point of a converging lens
- Focal point of a diverging lens
- Spherical aberration



U30011

Light Box

Set of equipment for optical experiments to be carried out on a table, consisting of a light box in a sturdy plastic housing and numerous optical components. Complete set in sturdy wooden storage case. The light box has four light outlets: the two side outlets have two hinged mirrors for experiments on colour mixing and shadows. All openings are equipped with mounts for optical components in 50x50 mm² slide frames. Parallel, convergent and divergent light can be generated by adjusting a converging lens attached in front of the lamp. There are two double-sided slit diaphragms available so that four different beam configurations can be created.

Lamp:	12 V, 36 W
Connections:	4-mm socket
Light box:	175x100x65 mm ³ approx.
Storage case:	250x240x100 mm ³ approx.

U30011

Additionally required:

- U13900-230 Transformer 12 V, 60 VA (230 V, 50/60 Hz)**
or
U13900-115 Transformer 12 V, 60 VA (115 V, 50/60 Hz)

Contents:

- | | |
|---|--|
| 1 Light box | 1 Semi-circular object (transparent acrylic) |
| 8 Colour charts | 1 60° prism (transparent acrylic) |
| 1 Plane mirror (glass) | 1 Asymmetrical 90° prism (transparent acrylic) |
| 1 Concave mirror (metal) | 1 Symmetrical 90° prism (transparent acrylic) |
| 1 Convex mirror (metal) | 2 Slit diaphragms |
| 1 Bi-convex lens, large (transparent acrylic) | 8 Colour filters (in slide frame) |
| 1 Bi-convex lens, small (transparent acrylic) | 1 Pair of connector leads with 4-mm plugs |
| 1 Bi-concave lens (transparent acrylic) | 1 Spare lamp |
| 1 Parallel plate (transparent acrylic) | |

Spare Lamp for Light Box (not shown)

Spare lamp for light box, 12 V, 36 W.

U30039

The experiment system for fuel cells allows students to gradually investigate the world of fuel cells and solar-hydrogen technology in many illustrative and quantitative experiments.

Experiment Topics:

- Current-voltage curve of a solar cell.
- Power curve and efficiency of a solar cell.
- Current-voltage curve of a PEM electrolyser
- Energy efficiency and Faraday efficiency of a PEM electrolyser
- Current-voltage curve of a PEM fuel cell
- Power curve of a PEM fuel cell

Contents:

- 1 Solar-hydrogen cell system consisting of solar module, PEM electrolyser, hydrogen and oxygen reservoirs, PEM fuel cell and fan
- 1 Resistor decade with maximum load capacity of 1 W
- 2 Multimeters
- 3 Connector leads, 50 cm, red
- 3 Connector leads, 50 cm, black
- 1 Stop watch
- 250 ml Distilled water
- 1 Storage case

U109552



U109552

Fuel Cell Experiment System

Solar-hydrogen cell system and accessories for carrying out student experiments. In a tough plastic box with foam inlay.



U109552



Enhance your lessons with a multitude of easily conducted experiments using the GASTEC gas detector.

Experiments:

Analysis of stuffy and of fresh air in a room.

Investigation of how carbon dioxide and oxygen content changes in the atmosphere due to the following processes:

- Burning of a candle.
- Breathing of people and animals.
- Photosynthesis of plants.
- Burning of organic substances.

Gas Analysis Made Child's Play:

- Open glass test tube using the tip to break off both ends and close the ends using protective rubber stoppers.
- Push the test tube into the hand pump and hold it at the required position.
- Suck air into the tube using the pump and wait 30 seconds.
- Take the test tube out of the hand pump and read off the gas content from the degree of coloration.



Basic Student Experiments

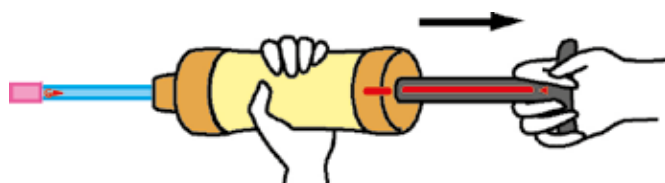

Set of 10 CO₂ Test Tubes, 0.03 – 1.00% by vol. (not shown)
Set of 10 test tubes for the GASTEC gas detector, used for detecting changes in carbon dioxide content in the atmosphere due to combustion processes, for comparison of fresh and stuffy air or observing photosynthesis in plants.

W11731

Set of 10 CO₂ Test Tubes, 0.5 – 8.0% by vol. (not shown)
Set of 10 test tubes for the GASTEC gas detector, used for detecting changes in carbon dioxide content in the atmosphere due to combustion of organic materials or the breathing of people and animals.

W11732

Set of 10 O₂ Test Tubes, 6 – 24% by vol. (not shown)
Set of 10 test tubes for the GASTEC gas detector, used for detecting oxygen content of air in the atmosphere.

W11733

Set of 10 Pairs of Protective Rubber Stoppers (not shown)
Set of spares including 10 pairs of protective rubber stoppers for test tubes used with the GASTEC gas detector.

W11734

GASTEC Gas Detector

Easy to use gas detector for analysing gas content in the atmosphere. For use in countless fundamental experiments. Includes hand pump and accessories for pumping air into specific test tubes, from which the gas content can be read off by means of the degree of colouration of the adsorption material.

Contents:

- 1 Hand pump for pumping in samples
- 1 Break-off tip for test tubes
- 1 Set of 10 pairs of protective rubber stoppers
- 1 Sealing grease
- 1 Carrying case
- 1 Teaching poster with suggested experiments, many illustrations and detailed instructions

W11730

Additionally required:

- W11731 Set of 10 CO₂ Test Tubes, 0.03 – 1.00% by vol.**
- or
- W11732 Set of 10 CO₂ Test Tubes, 0.5 – 8.0% by vol.**
- or
- W11733 Set of 10 O₂ Test Tubes, 6 – 24% by vol.**



W11730

Student Experiments

3B NETlab™:

- Comprehensive range of data processing functions, including tangents, integration, curve matching, all kinds of formula calculations and interpolation.
- Data acquisition with date and time of each measurement.
- Recording and processing several series of measurements.
- Presentation of data in the form of graphs or tables, analogue or digital multimeter functions.
- Easy configuration of sensor and experiments on the basis of predefined experiment files.
- Text windows for comments about the experiment.
- Support for analogue and digital sensors.
- Automatic identification of sensors.

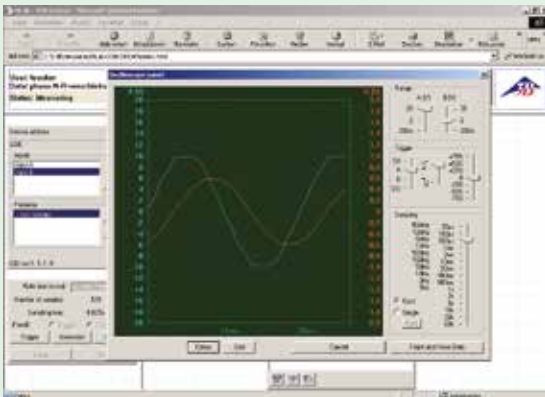

Oscilloscope: Voltage phase shift in RL series resonant circuit

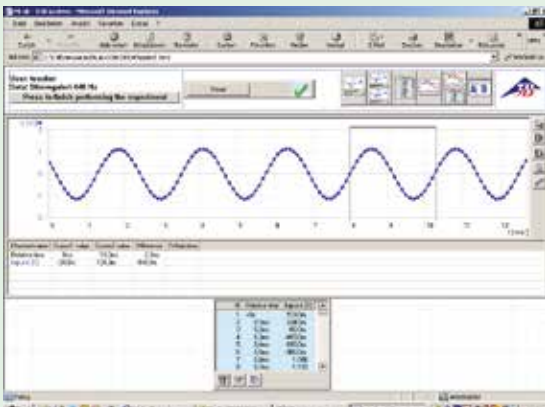

Sound amplitude of a tuning fork as a function of time

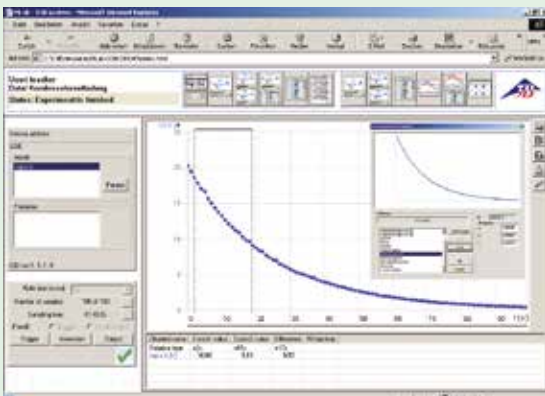

Discharge curve of a capacitor

**3B NETlab™**

3B NETlab™ is a data acquisition and data processing program for the 3B NETlog™ interface that can also be operated in a network. As it is based on ActiveX technology, all the available functions can be integrated into web pages that can be displayed and used with the Microsoft Internet Explorer browser. The main function of 3B NETlab™ is computer aided experimentation for science education. For that purpose, a large number of experiment instructions are available in the form of web pages. Users can navigate through these in the same way as they would browse the Internet and all the operations can be controlled with the help of facilities incorporated into the web pages at appropriate points. Experiment Instructions for carrying out experiments can also be written by teachers using standard HTML tools and the programming environment made available for the purpose. All kinds of Internet tools and technologies, such as multimedia sequences, animations, films, etc. can be incorporated into the experiment files. A software measuring lab is available for solo experimentation that utilizes all the functions of the functions of 3B NETlog™ interface. A wide range of graphical tools is available for processing experimental data. Thanks to its networking capability, 3B NETlab™ is ideally suited for use in schools. It enables teachers to check on the status and results of students' experiments from their own desk. Conversely, an experiment that is being carried out by the teacher can be followed by students on their own monitor screens.

U11310**Licensing:**

3B NETlab™ contains a specified location license for the normal use of the computer program throughout a school or educational establishment, including the preparation of school or student work at home.

System requirements:

Windows XP and Microsoft Internet Explorer up to version 8
 Windows 7 (32-bit and 64-bit) and Microsoft Internet Explorer up to 11 or higher
 Windows 8.1 (32-bit und 64-bit) and Microsoft Internet Explorer up to 11 or higher
 32-bit (x86) or 64-bit (x64) processor with a speed of at least 1 GHz
 At least 1 GB RAM
 At least 500 MB hard disc memory
 Monitor with a resolution of 1024x768 pixels or higher
 USB port

3B NET/log™

3B NET/log™ can be used as an interface for data acquisition linked to a computer, or as a hand held instrument with a data-logger for measurements of current and voltage or in combination with various sensors. It incorporates sensor connectors with automatic identification of sensors. It can be connected to a computer via USB. Can optionally be connected via Ethernet to the same sub-net of an Intranet. Includes USB cable and installation CD with data transfer program and plug in power supply.

- Channels: 2 Differential amplifiers (A and B)
- Measuring ranges: 0 – ±200 mV, 0 – ±2 V, 0 – ±20 V
- Connectors: Two twin 4 mm safety sockets
- Current input:
 - Channel: Parallel to A
 - Measuring ranges: 0 – ±200 mA, 0 – ±2 A
 - Connector: One twin 4 mm safety socket
- Analogue sensor inputs:
 - Channels: 2 (A and B)
 - Connectors: Two 8-pin miniDIN sockets
 - Sensor identification and calibration: Automatic
 - Triggering: Quasi-continuous
 - Sampling rate: 50 kilosamples/s
 - Resolution: 12 bit
- Voltage outputs:
 - Channels: 2 (A' and B'), with common ground connection
 - Voltage amplitude: 0 – ±5 V
 - Connectors: Two twin 4 mm safety sockets
- Analogue sensor outputs:
 - Channels: 2 (A' und B')
 - Connectors: Two 8-pin miniDIN sockets
 - Sampling rate: 10 kilosamples/s
 - Resolution: 12 bit

- Digital Inputs:
 - Channels: 4 (A, B, C, D)
 - A: TTL
 - B: TTL, high-speed sampling rate, 100 kilosamples/s
 - C, D: High-speed optical coupler (galvanically isolated)
 - Connector: One 8-pin miniDIN socket
- Digital outputs:
 - Channels: 6 (A', B', C', D', E', F')
 - Signal: TTL
 - Connector: One 8-pin miniDIN socket
- Additional data:
 - Computer connection: USB port
 - Internal data storage: 128 k
 - Monitor display: Large display (64x122) for data on all channels
- Power supply: 4.5 V DC/300 mA or 3 batteries LR6 AA alternatively 3 NiCd or 3 NiMH rechargeable batteries

3B NET/log™ (230 V, 50/60 Hz)

U11300-230

3B NET/log™ (115 V, 50/60 Hz)

U11300-115

3B NET/log™ with Ethernet Port (230 V, 50/60 Hz)

U11300IP-230

3B NET/log™ with Ethernet Port (115 V, 50/60 Hz)

U11300IP-115





U8533380

U8533381-230
U8533381-115

U11365

Photo Gate

Infra-red photo gate for triggering the 3B NET/og™ unit (U11300-230 or U11300-115) or a digital counter (U8533341-230 or U8533341-115). For time measurements in experiments on free fall, motion on a track or pendulum oscillations and for counting pulses. It can be operated in internal mode using the built-in infra-red light source or in external mode with the aid of a laser pointer, which needs to be obtained separately. It then acts as a wide-range light barrier, allowing it to be used at sporting events, for example. The gate includes an operational indicator light, stand rod with screw thread, M6 bolt for attachment to a roller track (U35001) and connector lead with 8 pin miniDIN plugs.

Barrier spacing:	82 mm
Rise time:	60 ns
Spatial resolution:	< 1 mm
Time resolution:	0.1 ms
Dimensions (without rod):	120x80x22 mm ³

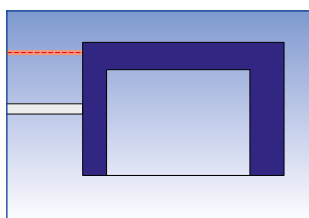

U11365

Additionally required for attaching multiple light barriers to 3B NET/og™ unit:

U11377 Digital Input Box

Also recommended for use connecting of photo gate to external digital counters:

U8533381-230 Connector Box (230 V, 50/60 Hz)

U8533381-115 Connector Box (115 V, 50/60 Hz)

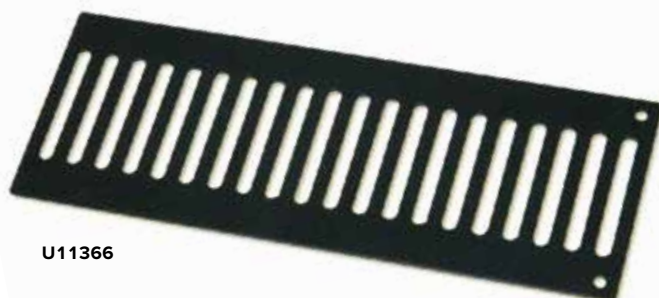

U11366

Connector Box

Connector box for use in connecting light barrier (U11365) or laser reflection sensor (U8533380) to external digital counters. Includes plug-in power supply 12 V AC.

Input: 8-pin miniDIN socket
Output: Two 4-mm safety sockets

Connector Box (230 V, 50/60 Hz)

U8533381-230

Connector Box (115 V, 50/60 Hz)

U8533381-115

Laser Reflection Sensor

Sensor for triggering the 3B NET/og™ unit (U11300-230 or U11300-115) or a digital counter (U8533341-230 or U8533341-115) in time measurements on moving objects. Suitable for opto electronic scanning of light and dark markings on moving objects or in conjunction with a reflecting foil to form a wide spaced obstruction sensor. The intensity of the laser beam is adjusted automatically according to the distance of the object. Includes reflecting foil, stand rod with screw thread and connector lead with 8-pin miniDIN plugs.

Maximum range: 2.5 m
Laser power: <1 mW
Laser protection class: II

U8533380

Additionally required for attaching multiple laser reflection sensors to 3B NET/og™ unit:

U11377 Digital Input Box

Also recommended for use connecting laser reflection sensor to external digital counters:

U8533381-230 Connector Box (230 V, 50/60 Hz)

U8533381-115 Connector Box (115 V, 50/60 Hz)

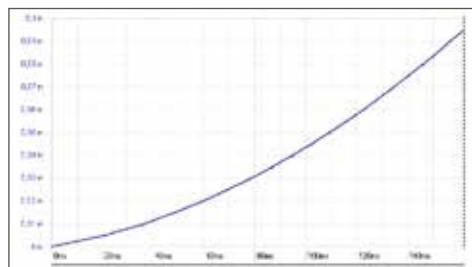

Distance travelled as a function of time

Picket Fence

Aluminium strip with 21 openings for determining gravitational acceleration g from time intervals recorded for a light beam passing through the individual openings of the strip as it falls freely past the beam. Anodised sheet aluminium with two holes for suspension of additional weights to demonstrate that the acceleration is independent of the mass.

Distance between rungs: 10 mm
Dimensions: 205x75 mm² approx.

U11366

Measurement of free fall using a picket fence





U11361



U11354



U11371

Ultrasonic Motion Sensor

Sensor for the measurement of unidimensional motion, e.g. on an air cushion track or in free fall. Can be used in conjunction with a 3B NET/log™ unit (U11300-230 or U11300-115) for manual measurements or for processing measurement data when connected to a computer. Includes connector lead with 8-pin miniDIN plugs and grill for protection against falling objects.

Measurement range: 0.15 m to about 11 m
 Resolution: 2 mm
 Accuracy: ±1%
 Sensor type: Electrostatic 50 kHz converter
 Sampling frequency: 10 Hz

U11361

Acceleration Sensor, ±25g

Sensor for the measurement of unidimensional collisions and all kinds of high acceleration motion. Can be used in conjunction with 3B NET/log™ unit (U11300-230 or U11300-115) for manual measurements or for processing measurement data when connected to a computer. Includes connector lead with 8 pin miniDIN plugs.

Measurement range: 0 – ±250 m/s²
 Resolution: 0.2 m/s²
 Accuracy: ±1%
 Sensor cable: 2 m
 Sensor type: Capacitive acceleration sensor

U11362



U11362

U11363

Acceleration Sensor, ±5g

Sensor for the measurement of unidimensional acceleration, e.g. of a rider on an air cushion track, of a coil spring pendulum or of a lift. Can be used in conjunction with 3B NET/log™ unit (U11300-230 or U11300-115) for manual measurements or for processing measurement data when connected to a computer. Includes connector lead with 8-pin miniDIN plugs.

Measurement range: 0 – ±50 m/s²
 Resolution: 0.03 m/s²
 Accuracy: ±1%
 Sensor cable: 2 m
 Sensor type: Capacitive acceleration sensor

U11363

Displacement Sensor

Sensor with rotating wheel for detecting displacement via a string. Includes stand rod with thread and connector lead with 8-pin miniDIN plugs.

Wheel: 24 mm diam.
 Maximum displacement: 66 mm approx.
 Displacement resolution: 1/8 mm approx.

U11371

Force Sensor, ±50 N

Force sensor for the measurement of unidimensional forces, with tare function. Can be used in conjunction with a 3B NET/log™ unit (U11300-230 or U11300-115) for manual measurements or for processing measurement data when connected to a computer. Includes connector lead with 8 pin miniDIN plugs.

Measurement ranges: 0 – ±5 N, 0 – ±50 N
 Accuracy: ±1%
 Sensor type: Metal strip strain gauges

U11354

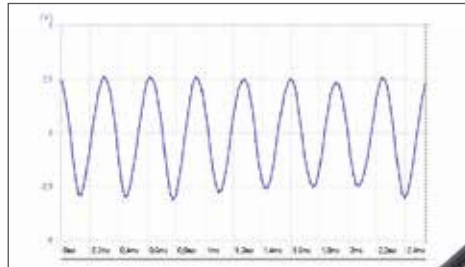

Sound amplitude of a tuning fork as a function of time



U11367

Microphone

Sensor for the measurement of the relative acoustic pressure or for plotting sound wave patterns, e.g. of voices or musical instruments. With built in electret microphone. Can be used in conjunction with a 3B NET/log™ unit (U11300-230 or U11300-115) for manual measurements or for processing measurement data when connected to a computer. Includes connector lead with 8 pin miniDIN plugs.

Frequency range: 50 Hz – 20 kHz
 Microphone cable: 2 m

U11367

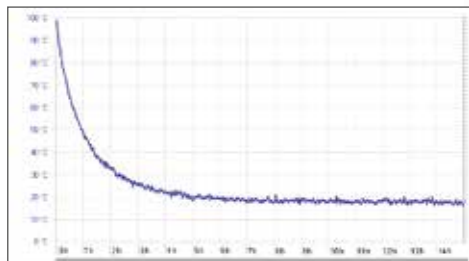

Fall in temperature as a function of time



Demonstration of Newton's law of cooling

UV-A/B Sensor

Sensor box with built-in photodiode for measurements in the UV A / UV B spectra. For use in conjunction with 3B NET/log™ unit (U11300-230 or U11300-115) for manual measurements or measurement acquisition via computer. Includes screw-in aperture, UV-A filter (SCHOTT UG-1) and connector lead with 8-pin miniDIN plugs.

Measuring ranges: 0 – 70 mW/m², 0 – 7 W/m², 0 – 700 W/m²

Max. spectral sensitivity: 21 mA/W approx. at 300 nm

Filter level

for visible light: 50

Sensor type: Titanium dioxide Schottky diode with built-in filter for visible light

U11369



U11360

Temperature Sensor, TC – K

Temperature sensor for the measurement of extremely low and extremely high temperatures, for example in liquid nitrogen or liquid oxygen, or inside a flame. With room temperature compensation. The immersible NiCr-Ni sensors (U11854 and U11855) can also be connected to the sensor box. Can be used in conjunction with a 3B NET/log™ unit (U11300-230 or U11300-115) for manual measurements or for processing measurement data when connected to a computer. Includes connector lead with 8-pin miniDIN plugs.

Measurement range: -270°C to 400°C

Accuracy: 0.2% plus 3°C (-270°C – 0°C)

0.1% plus 2°C (0°C – 400°C)

Resolution: 1°C

Sensor type: NiCr-Ni (type K)

Sensor length: 60 cm approx.

U11331



U11369

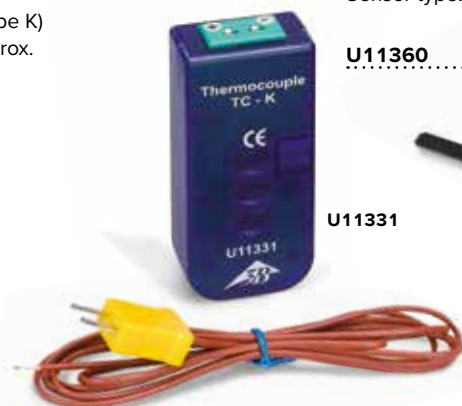

U11331



U11359



U11330

U11329

Temperature Sensor, Pt100

Temperature sensor for the measurement of temperatures in organic liquids, solutions of salts, acids, and bases. The stem and tip of the temperature sensor are of stainless steel. Can be used in conjunction with 3B NET/log™ unit (U11300-230 or U11300-115) for manual measurements or for processing measurement data when connected to a computer. Includes connector lead with 8-pin miniDIN plugs.

Measurement

range: -50°C – 150°C

Resolution: 0.1° C

Accuracy: 0.1% of measured

value plus 0.25°C

Sensor cable: 1 m, with silicone insulation

Sensor type: Pt100 thermo-couple

U11330

Temperature Sensor, Pt100 with Measurement Terminal

Temperature sensor for the measurement of temperatures on the copper tubing of a heat pump (U8440600-230/U8440600-115). Temperature sensor shaft made of rust-proof stainless steel. Tip with matching copper terminal. Can be used in conjunction with 3B NET/log™ unit (U11300-230 or U11300-115) for manual measurements or for processing measurement data when connected to a computer. Includes connector lead with 8-pin miniDIN plugs.

Measurement

range: -50°C – 150°C

Resolution: 0.1° C

Accuracy: 0.1% of measured value plus 0.25°C

Sensor cable: 1 m, with silicone insulation

Sensor type: Pt100 thermo-couple

U11329

Magnetic Field Sensor

±100 mT

Sensor for the measurement of magnetic flux density in the tangential direction. Can be used in conjunction with 3B NET/log™ unit (U11300-230 or U11300-115) for manual measurements or for processing measurement data when connected to a computer. Includes connector lead with 8-pin miniDIN plugs.

Measurement

ranges: 0 – ±2 mT,

0 – ±20 mT,

0 – ±100 mT

Resolution: 0.01 mT, 0.1 mT,

1 mT

Accuracy: ±1.5%

Sensor type: Linearised Hall sensor

U11360

Magnetic Field Sensor

±2000 mT

Sensor for the measurement of magnetic flux density in the tangential direction. Can be used in conjunction with 3B NET/log™ unit (U11300-230 or U11300-115) for manual measurements or for processing measurement data when connected to a computer. Includes connector lead with 8-pin miniDIN plugs.

Measurement

ranges: 0 – ±200 mT,

0 – ±2000 mT

Resolution: 0.1 mT, 1 mT

Accuracy: ±1.5%

Sensor type: Linearised Hall sensor

U11359



U11315



U11336



U11375



U11325

High Current Sensor, 10 A

Sensor for the measurement of high electric currents in DC and AC circuits using a shunt resistor. Capable of withstanding loads up to 20 A for short periods. Can be used in conjunction with a 3B NET/log™ unit (U11300-230 or U11300-115) for manual measurements or for processing measurement data when connected to a computer. Includes connector lead with 8 pin miniDIN plugs.

Measurement range: 0 – ±10 A
 Max. current loading: ±20 A for 15 s
 Accuracy: <1%
 Sensor type: Shunt resistor,
 5 mΩ/2 W

U11315.....

Humidity Sensor

Sensor for the measurement of relative humidity (RH). Suitable for weather studies and for monitoring conditions in a greenhouse or terrarium. Can be used in conjunction with a 3B NET/log™ unit (U11300-230 or U11300-115) for manual measurements or for processing measurement data when connected to a computer. Includes connector lead with 8-pin miniDIN plugs.

Measurement range: 0 – 95%
 (non condensing)
 Sensor type: Capacitive sensor
 Accuracy: 3% of RH plus 1% in the range from 0% – 95%
 5% of RH plus 1% in the range from 0% – 5%
 Resolution: 0.1%
 Response time: 15 s

U11336.....

Absolute Pressure Sensor, 2500 hPa

Sensor for the measurement of absolute pressure, e.g. in experiments on the Boyle-Mariotte law. Can also be used for measuring the production of O₂ during photosynthesis and for experiments on transpiration in closed systems. Can be used in conjunction with a 3B NET/log™ unit (U11300-230 or U11300-115) for manual measurements or for processing measurement data when connected to a computer. Includes plastic syringe, silicone tube, and connector lead with 8-pin miniDIN plugs.

Measurement range: 0 – 2500 hPa
 Accuracy: ±1%
 Resolution: 1 hPa
 Sensor type: Semiconductor sensor
 Hose nipple: 4 mm diam.
 Plastic syringe: 20 ml
 Silicone tube: 1 m

U11320.....



U11320



U11323



U11321

Electrometer Box

Impedance converter with high input resistance for the measurement of very small charges and currents. Can be used in conjunction with a 3B NET/log™ unit (U11300-230 or U11300-115) for manual measurements or for processing measurement data when connected to a computer. Includes connector lead with 8-pin miniDIN plugs.

Input resistance: ≥ 10¹¹ Ω
 Measurement error: ≤ 1.5%
 Connectors: 4 mm sockets

U11375.....

Relative Pressure Sensor, ±100 hPa

Sensor for the measurement of relative pressure, e.g. the hydrostatic pressure in a column of water or the pressure difference in a Stirling engine D (U8440450). Can be used in conjunction with a 3B NET/log™ unit (U11300-230 or U11300-115) for manual measurements or for processing measurement data when connected to a computer. Includes silicone tube and connector lead with 8-pin miniDIN plugs.

Measurement range: 0 – ±100 hPa
 Accuracy: ±1%
 Sensor type: Semiconductor
 Hose nipple: 4 mm diam.
 Silicone tube: 1 m

U11321.....

Barometer

Sensor for the measurement of atmospheric pressure. Can be used in conjunction with a 3B NET/log™ unit (U11300-230 or U11300-115) for manual measurements or for processing measurement data when connected to a computer. Includes silicone tube and connector lead with 8-pin miniDIN plugs.

Measurement range: 700 hPa – 1200 hPa
 Resolution: 0.1 hPa
 Accuracy: 1.5% of the maximum value of the measuring range
 Sensor type: Semiconductor sensor

U11325.....

Relative Pressure Sensor, ±1000 hPa

Sensor for the measurement of relative pressure, e.g. the pressure difference in the Stirling motor G (U10050). Can be used in conjunction with 3B NET/log™ unit (U11300-230 or U11300-115) for manual measurements or for processing measurement data when connected to a computer. Includes silicone tube and connector lead with 8-pin miniDIN plugs.

Measurement range: 0 – ±1000 hPa
 Accuracy: ±1%
 Sensor type: Semiconductor
 Hose nipple: 4 mm diam.
 Silicone tube: 1 m

U11323.....

U11396



Set of 30 Electrodes for ECG/EMG

Set of 30 electrodes for ECG/EMG box for single use.

U11398



U11398

Light Sensor

Light sensor for the measurement of luminous intensity. Can be used in conjunction with a 3B NET/og™ unit (U11300-230 or U11300-115) for manual measurements or for processing measurement data when connected to a computer. Includes connector lead with 8 pin miniDIN plugs.

Measurement ranges: 0 – 600 lux, 0 – 6000 lux, 0 – 150,000 lux

Resolution: 0.8 lux, 8 lux, 200 lux

U11364

Skin Resistance Box

Sensor for measuring the resistance of a person's skin as influenced by external factors (stress, "lie detection"). Designed to conform to the latest safety requirements. Can be used in conjunction with a 3B NET/og™ unit (U11300-230 or U11300-115) for manual measurements or for processing measurement data when connected to a computer. Includes connector lead with 8 pin miniDIN plugs.

Measurement range: 1 MΩ – 10 MΩ

Input resistance: >100 kΩ

Safety category: Safety class II, classification BF

U11393



U11393

Important note:

Our sensors for use with the 3B NET/og™ system are exclusively intended for educational purposes. No measurements obtained with them may be used for diagnosing the health of any individual.

ECG/EMG Box

Sensor box for reading electrocardiograms (ECGs) and electromyograms (EMGs) on skeletal musculature in three standard leads as defined by Einthoven. Feeds can be selected at the press of a button and are indicated by LEDs. For use in conjunction with a 3B NET/og™ unit (U11300-230 or U11300-115) for manual measurements or for computer-linked measurements. A connecting lead with 8-pin mini-DIN plugs is included.

Input resistance: > 10 MΩ

Output voltage: max. ±1 V

Blocked frequency: 50 – 60 Hz

U11396

U11392



Human Pulse Sensor Box

Sensor for measuring frequency of the human pulse at an earlobe or fingertip using an infra-red signal transmitter clip. Automatic adjustment of signal level. Designed to conform to the latest safety requirements. Can be used in conjunction with a 3B NET/og™ unit (U11300-230 or U11300-115) for processing measurement data when connected to a computer. Includes connector lead with 8 pin miniDIN plugs.

Measurement range: Pulse rates from 40 – 160 beats/min

Safety category: Safety class II, classification BF

U11392

U11364



Set of 3 Conductivity Standards

Set of 3 conductivity standards with conductivities 147, 1413 and 12880 $\mu\text{S}/\text{cm}$, each with a volume of 0.5 l.

U11334

Quinhydrone Buffer Solution (not shown)

Ready-to-use buffer solution with a pH of 7.00 for use with redox sensor.

Volume: 250 ml per container

U11352

pH-Sensor

Sensor for the measurement of pH values and redox potentials in aqueous solutions. Can be used in conjunction with a 3B NET/og™ unit (U11300-230 or U11300-115) for manual measurements or for processing measurement data when connected to a computer. Includes connector lead with 8 pin miniDIN plugs.

Measurement range: pH 0 – 14

Sensor type: Ag-AgCl combination electrode, gel filled, not refillable

Accuracy: pH 0.05 in range from 20°C – 25°C

Resolution: pH 0.01

Response time: ≤ 1 s to reach 95% of final value

U11350

Additionally recommended:

U11351 Buffer Solution

Buffer Solution

Set of buffer solutions in three flasks with pH values of 4.00, 7.00 and 9.00.

Volume: 250 ml each

U11351

U11351



U11334



Sensors

Determination of the pH value of an aqueous solution

Titration of acetic acid solution with sodium hydroxide solution

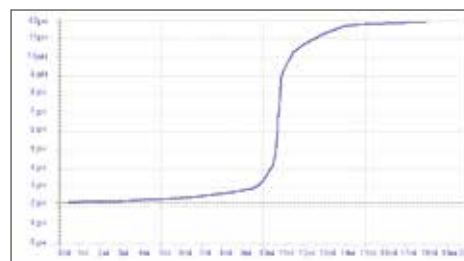

Conductivity Sensor

Sensor for measuring the specific electrical conductivity of liquid media, the total concentration of dissolved substances and the diffusion of ions through membranes, and for showing the difference in conductivity between ionic and molecular compounds and between strong and weak acids. The accessories supplied include a calibrating solution. Can be used in conjunction with a 3B NET/og™ unit (U11300-230 or U11300-115) for manual measurements or for processing measurement data when connected to a computer. Includes connector lead with 8-pin miniDIN plugs.

Measurement ranges: 0 – 200 μS , 0 – 2 mS, 0 – 20 mS

Resolution: 1 μS , 10 μS , 100 μS

Sensor type: measurement electrode using four wire technology, with graphite cells and integrated Pt100 temperature sensor

Accuracy: 5% without calibration, 0.5% with calibration

Sensor cable: 1.5 m

U11335



U11335



U11350

Computer Aided Experimentation



U11305-230
U11305-115



U11377



U11376

3B POWER/log

Programmable voltage and current source with power output for connection to the two analogue outputs of the 3B NET/log™ unit (U11300-230 or U11300-115). Includes plug in power supply and two connector leads with 8 pin miniDIN plugs.

Output power: 6 W
Current: 0 – ±1 A
Voltage: 0 – ±10 V
Bandwidth: 0 – 50 kHz

3B POWER/log (230 V, 50/60 Hz)

U11305-230

3B POWER/log (115 V, 50/60 Hz)

U11305-115

Additionally required:

U11310 3B NET/lab™

U11300-230 3B NET/log™ (230 V, 50/60 Hz)

or

U11300-115 3B NET/log™ (115 V, 50/60 Hz)

or

U11300IP-230 3B NET/log™ with Ethernet Port (230 V, 50/60 Hz)

or

U11300IP-115 3B NET/log™ with Ethernet Port (115 V, 50/60 Hz)

Relay

Power relay with a set of change over contacts for initiating measurements using 3B NET/lab™ software. The relay is controlled by the digital output of the 3B NET/log™ unit (U11300-230 or U11300-115) and it features both normally open and normally closed contacts. Safe potential separation between coil and contact set in accordance with VDE 0160. The contacts are made of a high performance silver alloy. Includes connector lead with 8-pin miniDIN plugs.

Max. switched voltage: 250 V AC / 220 V DC

Max. switched current: 6 A AC / 0.12 A DC

Max. switched power: 1500 VA

Min. switched power: 1 mW

Connectors: 4 mm safety sockets

U11368



U11368

Additionally required:

U11310 3B NET/lab™

U11300-230 3B NET/log™ (230 V, 50/60 Hz)

or

U11300-115 3B NET/log™ (115 V, 50/60 Hz)

or

U11300IP-230 3B NET/log™ with Ethernet Port (230 V, 50/60 Hz)

or

U11300IP-115 3B NET/log™ with Ethernet Port (115 V, 50/60 Hz)

Digital Output Box

Output box for connecting the digital outputs A, B, C and D of the 3B NET/log™ unit (U11300-230 or U11300-115) to four pairs of 4 mm safety sockets. Includes connector lead with 8-pin miniDIN plugs.

Output signal: TTL level
Connectors: 4 mm safety sockets

U11376

Digital Input Box

Input box for connecting the digital inputs A, B, C and D of the 3B NET/log™ unit (U11300-230 or U11300-115) to four miniDIN8 sockets. Includes connector lead with 8 pin miniDIN plugs.

Input and output signal: TTL level
Connectors: 8-pin miniDIN sockets

U11377



U11337

Redox Sensor

Sensor for measuring redox potentials in aqueous solutions. For use in conjunction with 3B NET/log™ unit (U11300-230 or U11300-115) for manual measurements or measurement acquisition via computer. Includes connector lead with 8-pin miniDIN plugs.

Measuring range: -450 mV to +1100 mV

Sensor type: Ag/AgCl combined electrode filled with gel, non-refillable

Precision: ±4.5 mV in a temperature range from 20°C to 25°C

Resolution: 0.9 mV

Response time: ≤ 1 s for 95% of final value

U11337

Additionally recommended:

U11352 Quinhydrone Buffer Solution

SW Sensors Set

Set incorporating two dynamometers and an amplifier board for recording and analysing mechanical oscillations using a standard oscilloscope. The dynamometers can be fitted to 10-mm diameter stands or the SW tie bar in order to measure dynamic forces along their axes. The amplifier board converts signals from both dynamometers so that they can be recorded and also evaluates the phase differences between both oscillation signals, outputting them as a DC signal. If the MEC amplifier board is connected to the 2 x 50 MHz USB oscilloscope (U112491), it is possible to perform detailed analysis and evaluation of measured signals using the oscilloscope software on a PC.

Dynamometers:

- Maximum force: 5 N
- Frequency range: 0.3 – 200 Hz
- Connectors: 3.5-mm jack plugs
- Dimensions: 52x37x26 mm³

MEC amplifier board:

- Input sockets: 3.5-mm jack sockets
- Output sockets: BNC
- Dimensions: 65x100x40 mm³

Contents:

- 2 Dynamometers
- 1 MEC amplifier board
- 1 Power supply, 12 V AC, 700 mA
- 2 HF Patch cords

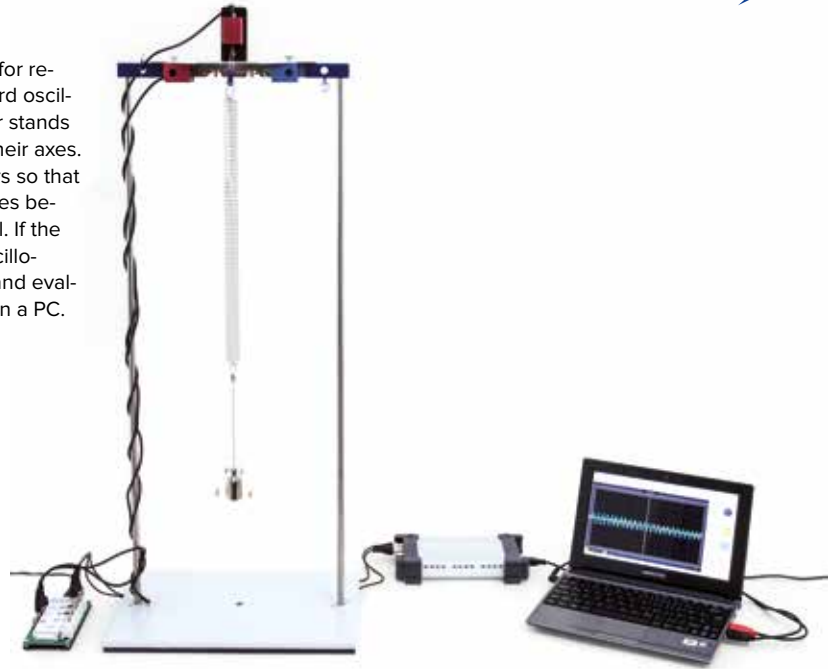

Wilberforce pendulum

Sensors

SW Sensors Set (230 V, 50/60 Hz)

U61023-230

SW Sensors Set (115 V, 50/60 Hz)

U61023-115

Additionally recommended:

- U112491 USB Oscilloscope 2x50 MHz**
- or
- U33070-230 Analogue Oscilloscope 2x20 MHz**



U61023-230
U61023-115

Software for Fourier Analysis

Software for Fourier analysis and synthesis with depiction of waveform and amplitude spectrum. Analysis of audio signals recorded using a microphone and sound card. Synthesis of Fourier components with an arbitrary choice of fundamental frequency for periodic signals. Signals can be listened to on audio. System requirements: Windows XP or higher, 512 MB RAM or higher, 128 MB graphics card or higher, 16 bit sound card or higher, microphone and speaker.

U8511700

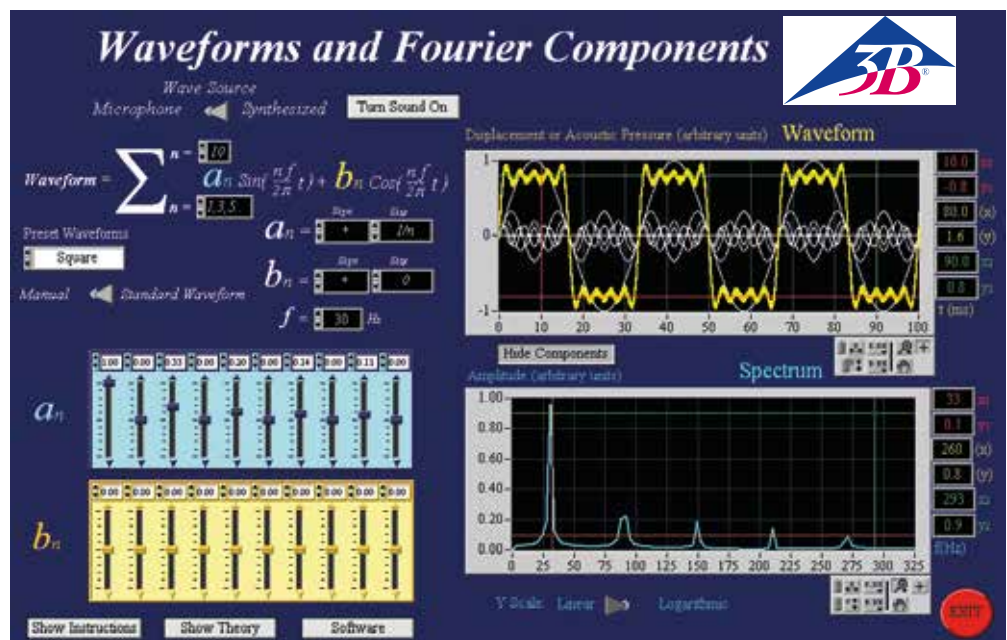

U8511700

Computer Aided Experimentation

Experiment Topics:

- Inclined plane
- Lever laws
- Torques and forces
- Forces acting on a lever arm
- Force as a vector
- Pendulum motion
- Physical pendulum
- Fixed and movable pulleys
- Block and tackle
- Hooke's law
- Coupled resonance
- Centre of gravity
- Friction

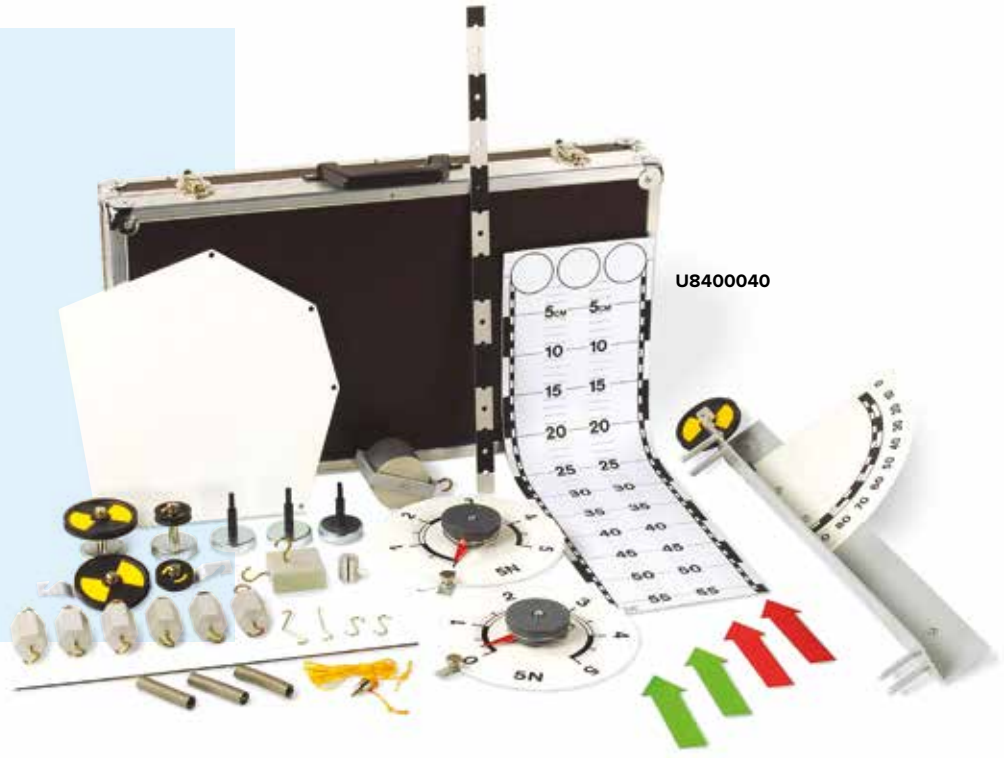

U8400040

Advantages

- Large components ensure that experiments can be viewed from a distance
- Secure attachment is guaranteed by high-grade AlNiCo magnets
- Quick and easy configuration of experiments
- Measuring units, vector diagrams and explanations can be provided right next to the experimental configuration on the blackboard

Mechanics Kit for Whiteboard

The mechanics kit for whiteboard demonstrations includes more than 25 large, coloured and easily distinguished components stored in a case with foam inlay. More than 30 experiments can be set up in rapid time.

U8400040

Additionally recommended:

U10030 Whiteboard, 600x900 mm²

or

U10031 Whiteboard, 900x1200 mm²

Contents:

- 1 Inclined plane with pulley and angle scale
- 1 Rolling mass, 500 g
- 1 Lever with 20 holes, 545 mm long
- 1 Pointer for lever, 400 mm long
- 1 Slotted counterweight with knurled screw, approx. 20 g
- 1 Pulley, double, 70 mm diam., 40 mm diam.
- 1 Pulley, 70 mm diam.
- 1 Pulley, 40 mm diam.
- 2 Round scale dynamometers, 5 N
- 3 Magnetic tabs with 8 mm axis
- 3 Springs with hook, $k = 6.2 \text{ N/m}$
- 1 Dual scale on a magnetic foil, 600x180 mm²
- 4 Arrows and one equilateral triangle on a magnetic foil
- 6 Weights with 2 hooks, 100 g each
- 1 Friction block
- 1 Set of nylon cords
- 1 Centre-of-gravity plate
- 1 Plumb
- 3 Rubber grommets
- 3 Brass hook
- 1 Brass clip
- 1 Storage case
- 1 Manual

U10031

U10030

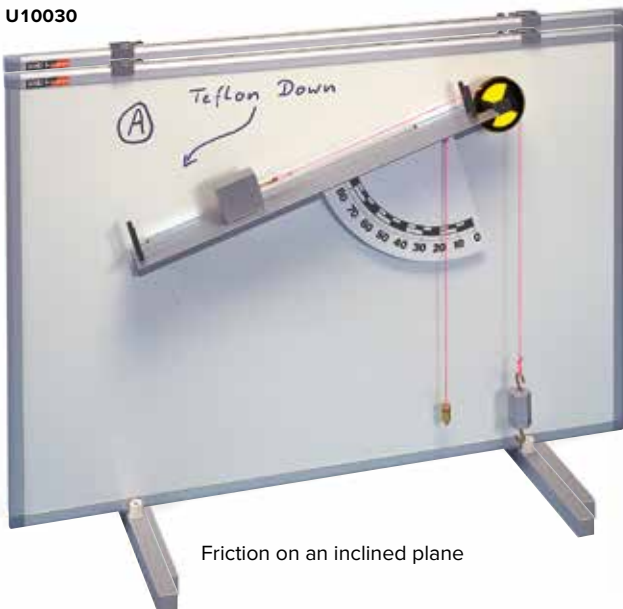

Friction on an inclined plane

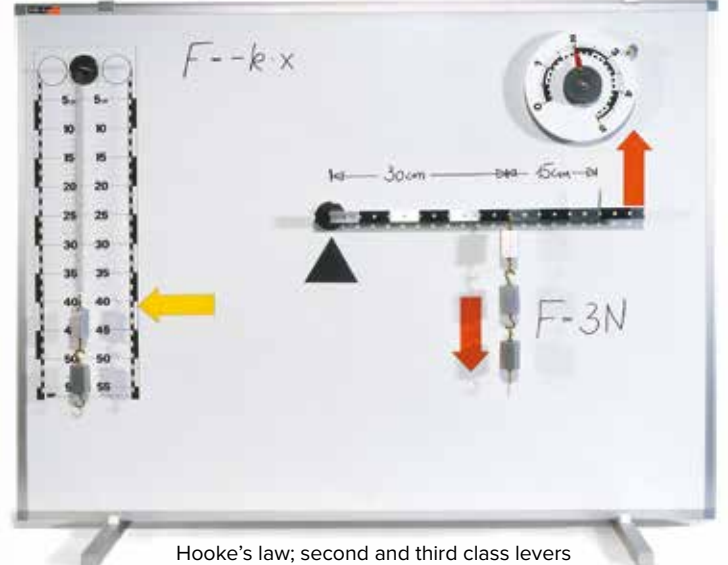

Hooke's law; second and third class levers

Mechanical Cumulative Stopwatch

Cumulative stopwatch with start, stop and reset buttons in shock-resistant plastic casing. Dual dial for minutes and seconds. With pendant cord.

Measuring range: 15 min
 Scale accuracy: $\frac{1}{10}$ s
 Diameter: 55 mm



U11901

U11901

Mechanical Stopwatches

Stopwatch in stainless steel casing with dual dial for minutes and seconds. In pouch with pendant cord.

Art. No.	Measuring range	Reading accuracy	Diameter
U40800	30 min	0.2 sec	45 mm
U40801	15 min	0.1 sec	45 mm

Digital Stopwatch

Stopwatch with 7-digit LCD display in robust plastic casing with start/stop and split/reset buttons for starting and stopping, cumulative, lap-time and dual-time measurement. Includes pendant cord.

Measuring range: 9 h, 59 min, 59 s, $\frac{99}{100}$ s
 Accuracy: $\frac{1}{100}$ s
 Battery: button cell 1.55 V, Type 389
 Dimensions: approx. 65x65x18 mm³



U11902

U11902



U40801

U40800

Timer

Stopwatch for counting up or down with acoustic alarm. Magnetic holder for attachment to metal surfaces and fold-away support legs.

Display: 4-digit LCD, 18 mm
 Timer range: 99 min 59 s
 Ticking rate: 1 s
 Dimensions: ca. 60x60x20 mm³

U16100



U16100



U11900

Table-Top Stop-Clock

Large quartz-controlled stop-clock with start stop and reset buttons, cumulative time and lap-time settings (clock resets to zero and starts timing again immediately). 2 hands, dial with dual scale for minutes/seconds and hundredths of a minute.

Measuring range: 60 min / 60 s
 Graduations: 1 s / $\frac{1}{100}$ min
 Dial: 110 mm diam.
 Dimensions: approx. 175x130x95 mm³

U11900

Digital Timer

We recommend the use of the digital timer (U8533341-230 or U8533341-115) along with one or two photo gates (U11365) for reliable measurement of the time a carriage on a track takes to cover a distance or when it obscures the light sensors. Also suitable for measuring oscillation periods of a swinging pendulum or similarly the times when it obscures the sensors. As an alternative to a light barrier, a laser reflection sensor (U8533380) can also be used for the opto-electronic sampling of light and dark markings on moving objects or can be used as a long-distance light barrier when connected in conjunction with reflective foil.

Digital Timer (230 V, 50/60 Hz)

U8533341-230

or

Digital Timer (115 V, 50/60 Hz)

U8533341-115

Photo Gate

U11365

or

Laser Reflection Sensor

U8533380

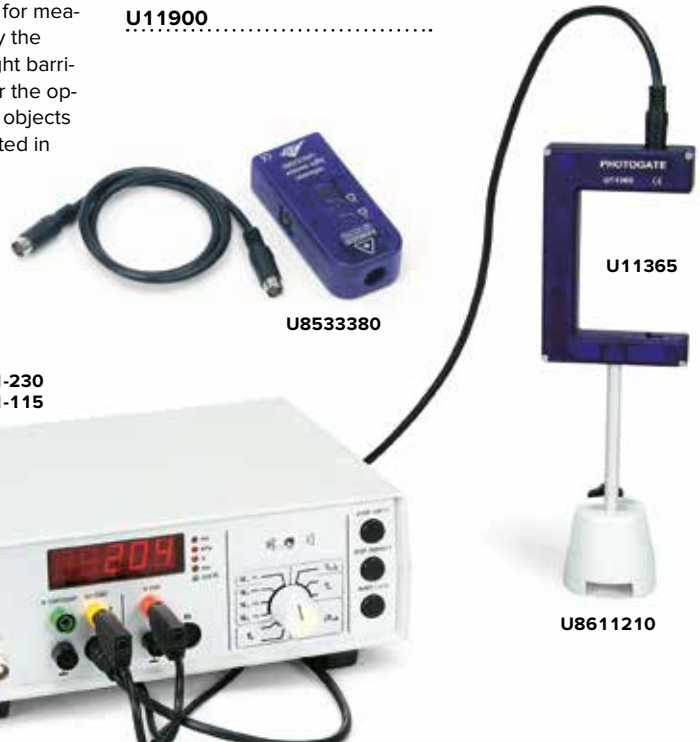

U8533341-230
U8533341-115

U8533380

U11365

U8611210

For measuring times when, e.g. a swinging pendulum obscures a sensor

Vertical Ruler, 1 m

Ruler with fastening pin (d = 12 mm) so that it can be set up vertically in a stand base. Scale as per U8401550.

U8401560.....

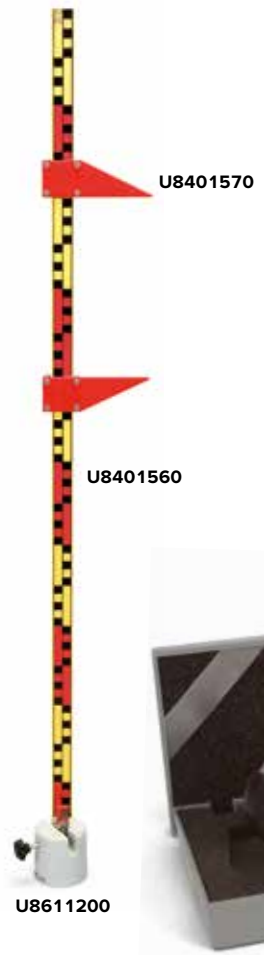

Pocket Measuring Tape, 2 m

Made of spring band steel, with locking button and rewinding spring.

Length: 2 m / 79 inch
Scales: cm, mm / 1/32 inch

U10073.....



Callipers S

Inexpensive callipers with 125 mm scale suitable for measuring internal and external dimensions and depths.

U29625.....



Set of Riders for Rulers

The set of riders consists of two red plastic pointers to match rulers U8401550 and U8401560 that can be used as movable cursors.

Dimensions: 120x40x20 mm³

U8401570.....



Ruler, 1 m

Wooden ruler with mm scale on one side and two-coloured cm scale on the reverse.

Cross section: 25x8 mm²

U8401550.....

Digital Callipers, 150 mm

For measuring internal and external dimensions and depth. Tempered stainless steel, LCD display. Including locking screw, adjustment from cm to inch, zero-calibration in any position, with plastic pouch.

Measuring range: 150 mm / 6 inch

Graduation: 0.01 mm / 1/128 inch

Display: 5-digit LCD, 6 mm

U10072.....



External Micrometer

Precision micrometer with thimble and locking system. Measuring surfaces coated with hardened metal, polished with fine lapping. Tempered measuring spindle with polished thread, chromed micrometer arc with insulation, scale drum and sleeve in matt-chrome finish. In plastic pouch.

Measuring range: 0 – 25 mm
Graduation: 0.01 mm

U10070.....



UE1010200
PDF online



U10071

Callipers, 150 mm

Precision callipers for measuring internal and external dimensions and depth. Tempered stainless steel, precision polished measuring surfaces, gauge with matt-chrome finish. In imitation leather pouch.

Measuring range: 150 mm / 6 inch

Graduation: 1/20 mm / 1/128 inch

U10071.....

Precision Spherometer

For measuring plate thicknesses, depressions and radii of curvature of spherical surfaces, for example, lenses. The device consists of a tripod with three steel tips which form an equilateral triangle. A micrometer screw with a measuring tip is recessed in the middle. Attached to the micrometer screw is a disc with circular divisions from 0 to 500 and a vertical scale with millimeter divisions from -10 to 15 mm at the tripod.

Measuring ranges: 0 – 25 mm and -10 – 15 mm
Screw pitch: 0.5 mm
Measuring accuracy: 0.001 mm
Support spacing: 50 mm

U15030.....

Additionally recommended:
U21885 Plane Mirror



U14200
U14201

UE1010100
PDF online

Watch Glasses from
U14200 and
U14201



Callipers Model
Model of a set of callipers suitable for measuring internal and external dimensions and depths of up to 300 mm.
Dimensions: 420x195 mm²
U29622

U29622

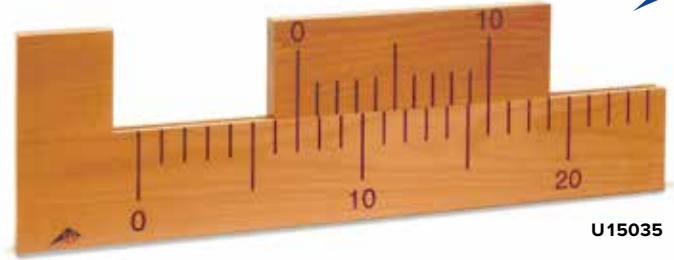

U15035

Vernier Model
For demonstrating Vernier readings on length measuring devices and protractors.
Length: 600 mm
Vernier length: 260 mm
Height: 190 mm

U15035



U30041

U30042

Wooden Rulers
These wooden rulers are a classroom staple.

Wooden Ruler, 1 m, Set of 10
U30041

Wooden Ruler, 0.5 m, Set of 10
U30042

U8404550



Object for Measurement Exercises
Irregularly shaped body, which is especially well suited for practising measurement using Vernier callipers.

U8404550



U30080

Vessel with Overflow, metal
Vessel with overflow, 900 ml, made of metal.

U30080



U8411310

Vessel with Overflow, Transparent
Vessel with overflow, 275 ml, made of Plexiglas.

U8411310

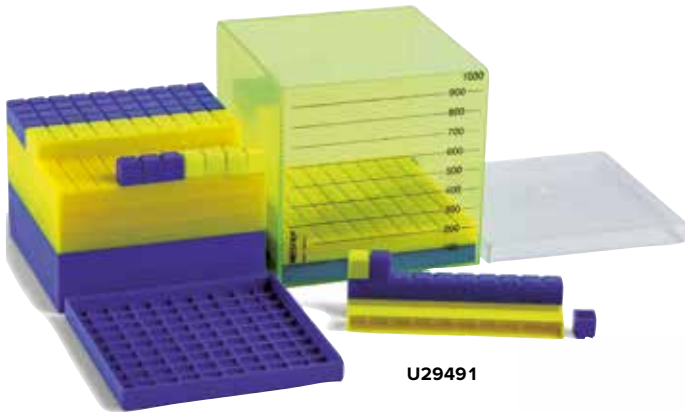

U29491

Broken Down Cubic Decimetre
Transparent and graduated cube of 100x100x100 mm³ with contents:
9 cuboids, 100 cm³ (4 yellows and 5 blues)
9 cuboids, 10 cm³ (4 yellows and 5 blues)
10 cubes, 1 cm³ (5 yellows and 5 blues)

U29491

Set of 1-Litre Bodies
Set of equipment consisting of 5 transparent hollow bodies with engraved volume scale.
Cylinder, 1 l 100 mm (diam.) x 120 mm approx.
Cylinder, 0.5 l 75 mm (diam.) x 115 mm approx.
Cylinder, 1 l 160 mm (diam.) x 50 mm approx.
Cube, 1 l 100x100x100 mm³ approx.
Cuboid, 1 l 200x100x50 mm³ approx.

U29812



U29812



U20030 – U20038

Advantages

- Precision
- Easy to read
- Colour coding

Precision Dynamometer

Colour coded precision dynamometer in a transparent plastic casing with easy-to-read scale, protection against over extension of the spring and zero-point calibration capability.

Precision: < 1% of total measuring range
 Scale division: 1% of total measuring range
 Dimensions: 280 mm x 16 mm diam.

Art. No.	Colour	Measuring range
U20030	Silver	0.1 N
U20031	Beige	0.2 N
U20032	Yellow	1 N
U20033	Red	2 N
U20034	Blue	5 N
U20035	Green	10 N
U20036	Violet	20 N
U20038	Brown	100 N



U11010 – U11013

Dynamometer, Transparent

Dynamometer with easily read scale printed on a transparent plastic sleeve. Suitable for projection using a projector. With protection against over extension of the spring.

Precision: $\pm 3\%$ of total measuring range
 Length: 185 mm
 Scale length: 60 mm

Art. No.	Measuring Range	Scale Division
U11010	1 N	0.02 N
U11011	2 N	0.04 N
U11012	5 N	0.1 N
U11013	10 N	0.2 N

Dynamometer, Colour Coded

Colour coded dynamometer for measuring weights or masses as well as forces. Scaled in newtons or grams and kilograms with zero-point calibration.

Art. No.	Colour	Measuring Range	Scale Division
U40810	Blue	250 g / 2.5 N	5 g / 0.05 N
U40811	Green	500 g / 5 N	10 g / 0.1 N
U40812	Brown	1000 g / 10 N	20 g / 0.2 N
U40813	Red	2000 g / 20 N	50 g / 0.5 N
U40814	White	3000 g / 30 N	50 g / 0.5 N
U40815	Yellow	5000 g / 50 N	100 g / 1 N



U40810 – U40815

Dynamometer with Round Dial

Spring dynamometer for experiment demonstrations. Grooved pulley on ball bearings and cord with hook. Large, easily read round dial. Zero-point calibration via knurled screw. With magnet for attachment to a whiteboard.

Diameter: 200 mm

Art. No.	Measuring range	Scale Division
U8402501	1 N	0.02 N
U8402502	2 N	0.05 N
U8402505	5 N	0.1 N
U8402510	10 N	0.1 N



Set of Helical Springs for Hooke's Law

5 helical springs with a hook and an attached pointer for determining spring constants

U40816

Spring constant	2.5 N/m	5 N/m	10 N/m	15 N/m	25 N/m
Length	122 mm	145 mm	150 mm	147 mm	142 mm
Diameter	15 mm	15 mm	19 mm	20 mm	20 mm

Additionally recommended:

U8404760 Set of Slotted Weights 10x 10 g, Red and Grey

U8401560 Vertical Ruler

U8401570 Set of Riders for Rulers

Stand equipment

Dynamometers for Demonstrating Hooke's Law

Two colour coded dynamometers in transparent plastic sleeve with easy-to-read cm/mm scale for demonstrating Hooke's law and calculating the spring constant. Protection against over extension of the spring and zero-point calibration.

Spring constants: 10 N/m and 20 N/m

Length of scale: 115 mm

Dimensions: 280 mm x 16 mm Ø

U20037

Additionally recommended

U30031 Set of Slotted Weights 10 g

U8401560 Vertical Ruler

Stand equipment

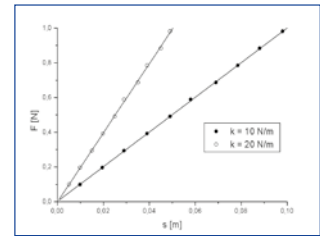
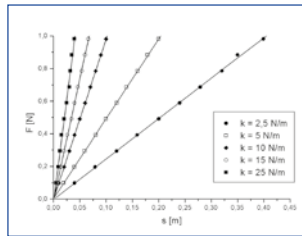

Helical Springs



Helical Springs

For experiments on expansion and oscillation, with two suspension eyelets. Tolerance 10%.

Art. No.	Spring constant	Length	Diameter
U8405840	1.5 N/m	120 mm	20 mm
U8405820	2.5 N/m	120 mm	16 mm
U15027	3.9 N/m	30 mm	34 mm
U8401010	5 N/m	60 mm	20 mm
U11025	16 N/m	115 mm	6 mm
U11026	43 N/m	110 mm	9 mm
U15028	20 N/m	180 mm	8 mm
U11027	86 N/m	95 mm	10 mm

Mechanics

Set of 10 Weights

Brass weights with hooks on both sides so that they can be suspended from one another.

Set of 10 Weights, 10 g

U8404710

Set of 10 Weights, 20 g

U8404700

Set of 10 Weights, 50 g

U8404720

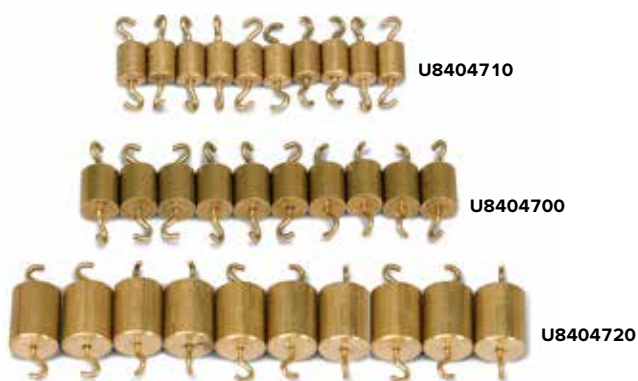

Sets of Slotted Weights on Weight Holder

Slotted brass weights and holder.

Art. No.	Designation	Weights (incl. holder)	Holder diam.
U30030	Set of slotted weights, 20 – 100 g	2x 5 g, 1x 10 g, 4x 20 g	22 mm
U30031	Set of slotted weights, 10x 10 g	10x 10 g	18 mm
U30033	Set of slotted weights, 5x 50 g	5x 50 g	32 mm
U30032	Set of slotted weights, 5x 100 g	5x 100 g	38 mm

Set of Slotted Weights on Holder, red and grey

Coloured slotted weights with holder for use in experiment demonstrations.

Art. No.	Designation	Weights (incl. holder)	Holder diam.
U8404760	Set of slotted weights, 10x 10 g, red and grey	10x 10 g	25 mm
U8404775	Set of slotted weights, 8x 50 g, red and grey	8x 50 g	25 mm
U8404785	Set of slotted weights, 4x 100 g, red and grey	4x 100 g	25 mm



Set of Weights 10 g to 1000 g

9-piece set of brass weights in storage box, each with hooks on both sides. 1x 10 g, 2x 20 g, 1x 50 g, 1x 100 g, 2x 200 g, 1x 500 g, 1x 1000 g

U30016

Set of Weights 1 g to 50 g

8-piece set of brass weights, delivered in storage box. 1x 1 g, 2x 2 g, 1x 5 g, 2x 10 g, 1x 20 g, 1x 50 g

U30012

Set of Weights, 1 g to 1000 g

13-piece set of brass weights in storage block. 1x 1 g, 2x 2 g, 1x 5 g, 1x 10 g, 2x 20 g, 1x 50 g, 1x 100 g, 2x 200 g, 1x 500 g, 1x 1000 g

U30014



Set of Weights 1 g to 500 g, slotted with Holder

13-piece set of brass weights on convenient storage rack.

1x 1 g, 2x 2 g, 1x 5 g, 1x 10 g, 2x 20 g, 1x 50 g, 1x 100 g, 2x 200 g, 1x 500 g, holder 50 g

U300131

Set of Weights 100 g to 2000 g

7-piece set of weights with hooks. 1x 100 g, 2x 200 g, 1x 500 g, 2x 1000 g, 1x 2000 g

U8671420





U29952

Set of Weights 1 mg to 500 mg

Set of 12 aluminium weights in a plastic box. 1x 0.5 g, 1x 0.2 g, 2x 0.1 g, 1x 0.05 g, 2x 0.02 g, 1x 0.01 g, 1x 5 mg, 2x 2 mg, 1x 1 mg.

U29952

Set of Weights 1 g to 500 g

12-piece set of brass weights in storage block. 1x 1 g, 2x 2 g, 1x 5 g, 2x 10 g, 1x 20 g, 1x 50 g, 2x 100 g, 1x 200 g, 1x 500 g.

U29576



U29576



U30019

Set of Three Weight Holders with Slotted Weights

Slotted brass weights on holder comprising 3 sets with 2x 5 g, 2x 10 g, 2x 20 g, 3x 50 g.

U30019



U17205

Beam Balance

Beam balance on hard plastic base plate. Aluminium beam on steel needle bearing with adjustment screws. Removable stainless steel balance pans. Usable also for hydrostatic experiments in connection with metal bridge (U17206) and Archimedes cup (U17207).

Maximum load: 500 g
Resolution: 20 mg
Pans: 120 mm diam.

U17205



U29543

Set of Weights with Hooks

11-piece set of weights with hooks on both sides so that they can be suspended from one another. Tolerance: 10%.

1x 1 g, 2x 2 g, 1x 5 g, 2x 10g, 1x 20 g, 1x 50 g, 2x 100 g, 1x 200 g.

U29543

Additionally recommended:

U29576 Set of Weights 1 g to 500 g

U29952 Set of Weights 1 mg to 500 mg

Bench Scales, Harvard Junior

Inexpensive and colourful two-pan scales made of plastic. No less stable or accurate than many more expensive scales. With high-precision manufactured metal beam, interchangeable pans and zero adjustment. Includes a set of 8 weights. Built-in interlock to protect against vibration during transport or during long-term storage. Stackable.

Maximum load: 2 kg
Precision: 0.5 g
Pans: 150 mm diam., plastic, shallow and high-sided versions

Set of weights: Set of 8, 370 g

U42047



U42047

Experiment Topics:

- Determining initial equilibrium position of a torsion pendulum
- Recording of damped oscillations around the final equilibrium position of a torsion pendulum over time
- Determining final equilibrium position of a torsion pendulum by final deflection method
- Determination of gravitational constant **G** from the period of oscillation and the difference between the equilibrium positions
- Determination of gravitational constant **G** by acceleration method

Oscillation about the two equilibrium positions



U40205
UE1010300
PDF online

Cavendish Torsion Balance

A Cavendish torsion balance demonstrates the force of gravity between two masses and allows the gravitational constant to be determined. Thanks to the short oscillation period of just 2 – 4 minutes, the gravitational constant can be determined within the space of a single lesson with an accuracy of better than 10%. The core of the apparatus is a torsion pendulum made of a light bar with two small lead spheres, which is suspended horizontally from a thin wire. The apparatus is moved from its equilibrium position by the attraction of the two spheres to two larger lead spheres. When the two large spheres are rotated to a new position, the torsion balance will oscillate about a new equilibrium position. The rotary motion is measured using a capacitive differential sensor, which largely suppresses noise and vibration components in the signal. The output is then recorded using a computer. For subsequent evaluation, the data can be exported to a spreadsheet. Alternatively, the motion can be demonstrated with the aid of a light pointer.

- Mass of large lead spheres: 1 kg
- Mass of small lead spheres: 15 g
- Gravitational attraction: $< 10^{-9}$ N
- Torsion wire: Tungsten, 25 μ m
- Period of oscillation: 2 – 4 mins
- Angular resolution: 25 microradians
- Sampling rate: 0.5, 1, 2, 5, 10 samples/s
- Dimensions: 190x180x200 mm³
- Weight: 5 kg

Includes:

- 1 Cavendish torsion balance
- 1 Measurement software
- 1 USB cable

U40205

Additionally recommended:

U22000 Diode Laser, Red 650 nm

Stand equipment

Tungsten Wire (not shown)

- Roll of torsion wire for Cavendish torsion balance (U40205).
- Diameter: 25 μ m

U40210

Experiment Topics:

- Day and night
- Seasons
- Phases of the moon
- Solar and lunar eclipses and their cycles

Orbit™ Tellurium

Attractive and easy-to-operate three-dimensional model of the sun, moon and earth, for comprehensive demonstration of their motions. Earth and moon in two different sizes in order to demonstrate day and night, motion of the sun across the sky, annual seasons, the changing amounts of daylight, phases of the moon, as well as solar and lunar eclipses and the cycles they exhibit. Shadows have clear edges since the sun is represented by a bright lamp with a Sunbeam™ reflector. As an alternative to turning the whole system together, the rotation of the earth on its axis and the position of the moon in its orbit can be adjusted individually by hand. Dimensions: 650x250x300 mm

Includes:

- Tellurium with earth and moon in two sizes; display cards showing dates, solar eclipses, lunar eclipses and phases of the moon; small figure; sundial; detailed instructions in English; mains transformer, 100 – 240 V/6V

U19600



U19600

Advantages

- Greater reading accuracy thanks to having two angle scales
- Can be extended to feature four force components

Force Table

Equipment for quantitative investigation of the combination and resolution of forces, consisting of a circular workplate on a stable base with dual protractor scale. Weights from set of three weight holders with slotted weights U30019 (included), are suspended from 3 cords strung over pulleys with ball bearings.

Dimensions: approx. 300 mm x 390 mm \varnothing

Weight: approx. 3,1 kg

U52004

Additionally recommended:

U52011 Extra Pulley

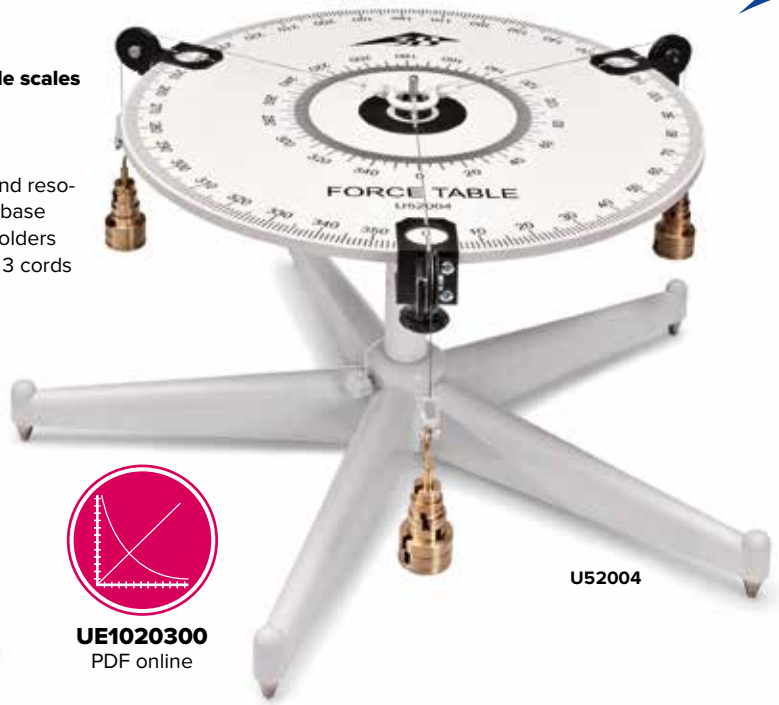

U52004

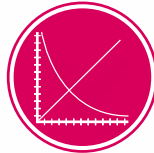

UE102030
PDF online



U52011

Extra Pulley

Additional pulley for use with the force table (U52004) with clamp, cord and holder with set of slotted weights 2x 5 g, 2x 10 g, 2x 20 g and 3x 50 g.

U52011



U10074

Universal Spirit Level, 250 mm

Spirit level made of shock resistant plastic for measuring angles to horizontal, vertical and inclined planes and for joinery. With two plexi-glass level gauges, resistant to breakage and leakage. Horizontal gauge built-in and accurately calibrated. Gauge for measuring inclination can be rotated and fixed in place. Scale markings for 45°, 60° and 120°, mm scale on measuring surface, protractor scale for inclination gauge.

Scales: 250 mm/1 mm, -90° – +90°/2°

Dimensions: 250x54x15 mm³

U10074

Stability Apparatus

For demonstrating the stability of an object as a function of the position of its centre of gravity above the supporting surface. The position of the centre of gravity can be adjusted by tilting the device. The position of the centre of gravity over the base of the stand is indicated by a built-in plumb bob.

Dimensions: 180x150x290 mm³

U15033



U15033

Centre-of-Gravity Plate

Plastic plate with 6 boreholes for introducing the concept of centre of gravity and determining centroids.

U8409270

Additionally required:

U15015 Plumb with Line



U8409270



U15015

Plumb with Line

Brass body with a line.

Height: 100 mm

Diameter: 20 mm

Weight: 220 g

Line length: 1600 mm

U15015

U15015

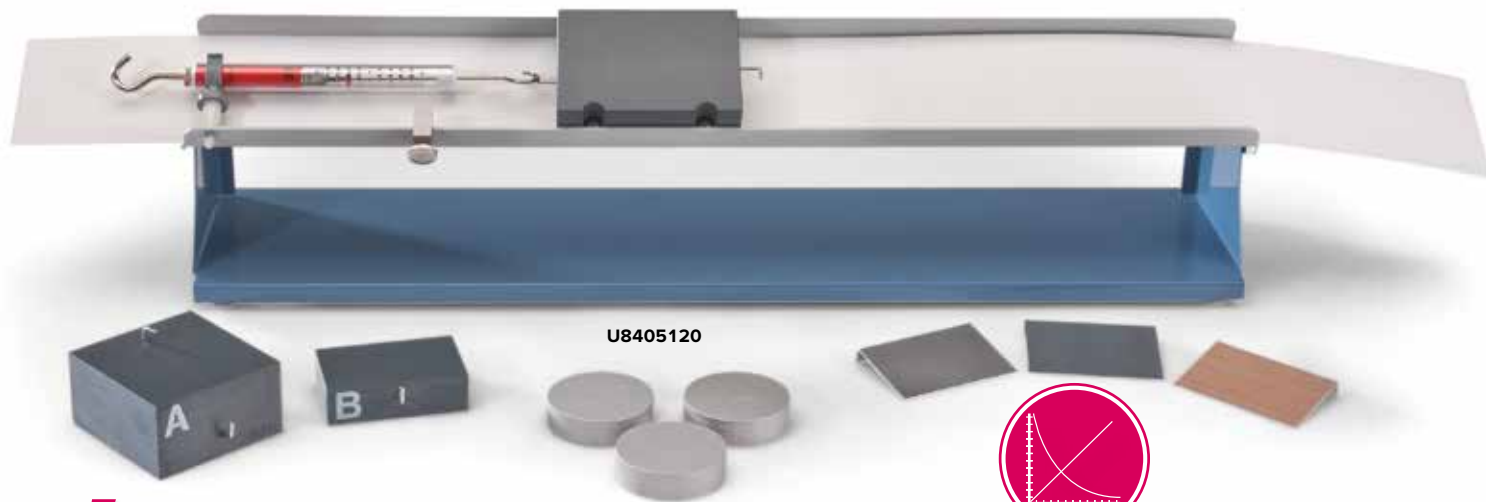

U8405120

Advantages

- Complete apparatus: additional accessories not required
- Robust, durable

Friction Measuring Apparatus

Demonstration apparatus with movable friction surface for measuring static and dynamic friction between two surfaces as a function of area, force between the surfaces or the combination of materials. For easy measurement of dynamic friction, the movable surface is moved at constant speed under a static body connected to a dynamometer. The friction track can be inclined along its length in order to vary the force between the two surfaces.

Dimensions: 600x140x150 mm³

Weight: 3 kg

Contents:

Basic apparatus with movable friction surface, 2 N dynamometer, three different static bodies, three rails for holding static bodies, three 100 g weights.

U8405120



UE5010500

PDF online



U20032
U20033
U20035

Precision Dynamometer

Colour coded precision dynamometer in a transparent plastic casing with easy-to-read scale, protection against over extension of the spring and zero-point calibration capability.

Precision: < 1% of total measuring range

Scale division: 1% of total measuring range

Dimensions: 280x16 mm diam.

Art. No.	Colour	Range
U20032	Yellow	1 N
U20033	Red	2 N
U20035	Green	10 N

Block for Friction Experiments

Aluminium block with a teflon-coated surface and 2 hooks.

Dimensions: 55x50x25 mm³

U8409250

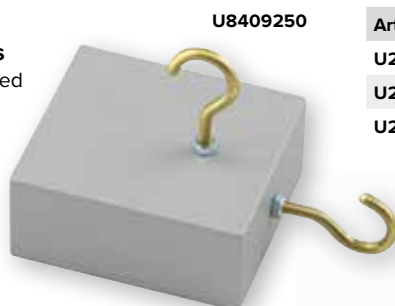

U8409250

Wooden Blocks for Friction Experiments

Two wooden blocks with plastic coated surfaces and hook for attaching a dynamometer.

Dimensions: approx. 120x60x60 mm³ and 120x60x30 mm³

U15026

Additionally recommended:

U20032 Precision Dynamometer, 1 N

U20033 Precision Dynamometer, 2 N

U20035 Precision Dynamometer, 10 N

U30014 Set of Weights, 1 g to 1000 g



U15026



U30028

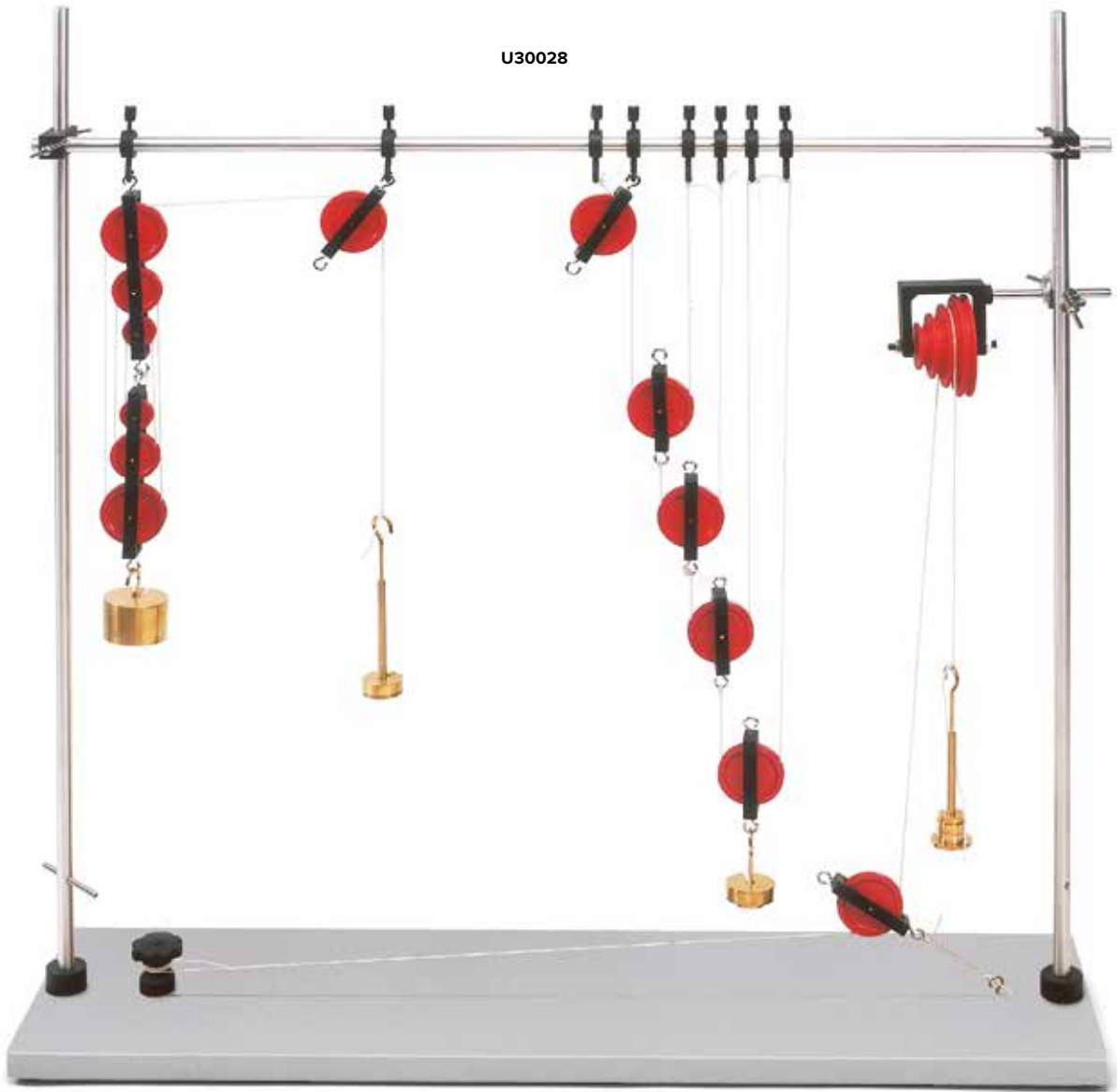

Experiment topics:

- Fixed pulley
- Movable pulley
- Block and tackle
- Wheel on axle

Experiment Set Pulleys and Block and Tackle

For demonstrating how forces can be altered in direction and distributed over an area by simple machines (fixed and movable pulleys, block and tackle) and introducing the concepts of mechanical work, power and energy. Complete set of equipment consisting of a stable base plate, retort stand rods, pulley blocks, block and tackle, a set of pulleys of various diameters on an axle, weight holders, slotted weights and a reel of cord. All the experiments can be set up quickly and easily since the closed plastic frame around the pulleys prevents the cord from slipping.

Base plate: 810x200 mm²
 Pulleys: 50 mm diam.

Stand rods: 810 mm x 12,5 mm diam.
 Slotted weights: 2x 10 g, 2x 20 g, 2x 50 g, 4x 100 g, 4x 200 g, 1x 500 g
 Holders: 1x 10 g, 1x 20 g, 5x 50 g

Contents:

1 Base plate	2 Tandem pulley blocks with 3 pulleys
3 Stand rods	1 Wheel on axle
2 Plastic clamps	15 Slotted weights
1 Universal sleeve	7 Weight holders
8 Hooks	1 Reel of cord
7 Pulley blocks with 1 pulley	1 Screw pin
2 Pulley blocks with 4 pulleys	

U30028

Additionally required:

- U10073 Measuring Tape, 2 m
- U11012 Dynamometer 5 N
- U40801 Mechanical Stopwatch, 15 min

Pulley with Table Clamp

Pulley for altering the direction of forces. Plastic pulley with ball bearings and cord groove plus securing clamp. Also has a bore so that it can be attached to a retort stand of up to 12.5 mm diameter.

Pulley: 50 mm diam.
Span of bracket: up to 35 mm span

U30025



U30025

Pulleys and Block and Tackle

For experiments with fixed and movable pulleys. Non-deformable, low-friction pulleys with cord grooves and hooks at the ends of both axles for suspending from fixed supports or other pulleys. The enclosed design of the plastic frame prevents the cord from slipping off the pulley.

U30020



U30021



U30027

U30026

Art. No.	Designation	Pulleys	Diameter	Material
U30020	Pulley block	1	50 mm	plastic
U30021	Pulley block	2	50 mm	plastic
U30022	Pulley block	3	50 mm	plastic
U30026	Tandem pulley	2	37/50 mm	aluminium
U30027	Tandem pulley	3	25/37/50 mm	aluminium

Lever

Complete set of equipment for demonstrating laws of leverage and for experiments on equilibrium. Consists of a retort stand to which is attached a lever mounted on ball bearings with three rows of holes for adjusting the axis of rotation or for suspending weights, red and white block scale with pointer for accurate display of equilibrium state. Can also be used to model balance scales. Includes set of weights 10x 50 g.

Length of lever: 1 m
Mass of lever: 0.458 kg
Number of holes: 21
Separation of holes: 50 mm

U8552001

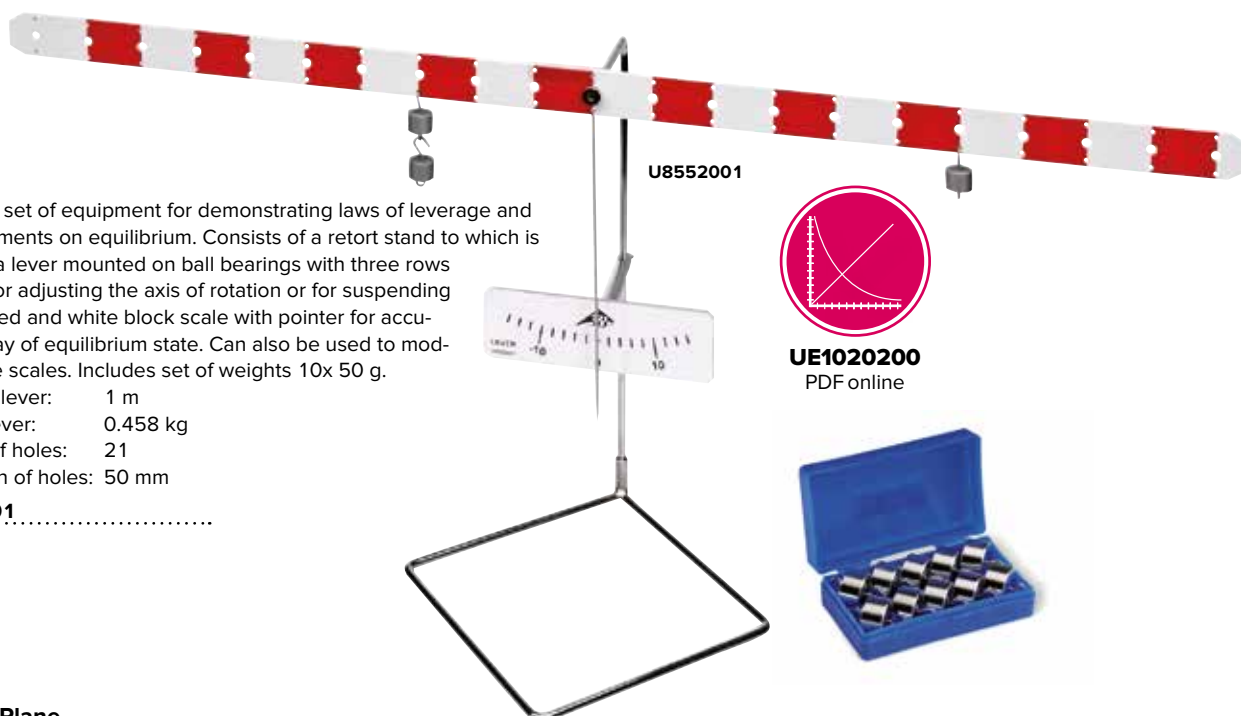

U8552001

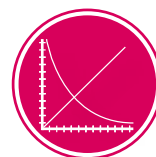

UE1020200
PDF online

**Inclined Plane**

Equipment for investigating forces acting on a body on an inclined plane, and determining the holding friction as a function of the angle of inclination. Metal base and inclined plane. The plane is hinged with scales for angle, length and height. Angle of inclination can be adjusted between 0 and 45°. Includes adjustable pulley, roller, weight pan and cord.

Length of inclined plane: 600 mm
Length of base: 450 mm
Scales: divided into cm or degrees

U30015

Additionally recommended:

U11013 Dynamometer, 10 N

U29576 Set of Weights 1 g to 500 g



U30015



UE1020400
PDF online

Experiment Topics:

- Regular movements and movements with uniform acceleration
- Newton's laws of motion
- Conservation of energy
- Elastic and inelastic collisions



U35001



UE1030250
PDF online

Trolley Track

Track with two trolleys and other accessories for investigating linear motion, plus three adjustable point supports for setting horizontal alignment. The trolleys move with minimum friction on wheels with high-quality ball-bearings. They are fitted with magnets at their front ends for experiments involving both elastic and inelastic collisions. Including a spoked wheel suitable for use as a pulley with the trolley track. It can be used in combination with a light barrier (U11365) for recording the motion of a trolley.

Mass of trolleys: 500 g
Length of distance scale: 1800 mm
Overall length: 1800 mm

Contents:

- 1 Track, 1.8 m
- 1 Two-point support
- 1 Single point support with end stop
- 1 Trolley
- 1 Trolley with interchangeable buffer pad
- 1 Additional weight, 500 g
- 2 Holder for light barrier
- 1 Holder for pulley
- 1 Pulley
- 1 Clamp for stand rods
- 1 Set of contact-breakers
- 1 Set of magnets

U35001

Additionally recommended:

- U8613283 Cord, 100 m
- U30031 Set of Slotted Weights, 10 x 10 g
- U11365 Photo Gate (2x)
- U11300-230 3B NET/log™ (230 V, 50/60 Hz) or
- U11300-115 3B NET/log™ (115 V, 50/60 Hz)

- U8613283 Cord, 100 m
- U30031 Set of Slotted Weights, 10 x 10 g
- U11361 Ultrasonic Motion Sensor

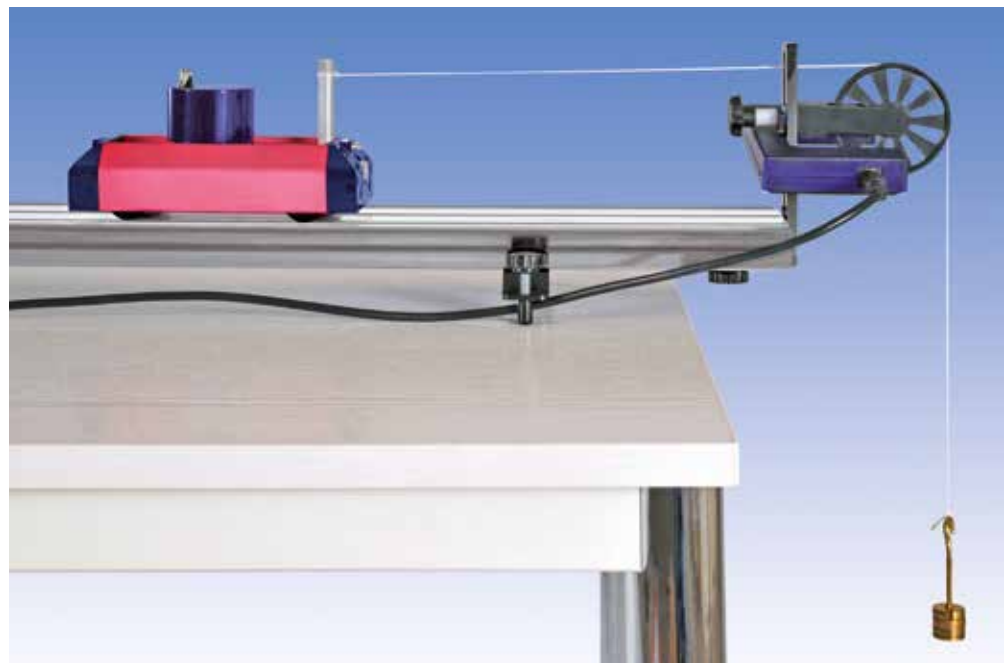

- U11300-230 3B NET/log™ (230 V, 50/60 Hz) or
- U11300-115 3B NET/log™ (115 V, 50/60 Hz)

- U8613283 Cord, 100 m
- U30031 Set of Slotted Weights, 10 x 10 g
- U11365 Photo Gate (2x)
- U11300-230 3B NET/log™ (230 V, 50/60 Hz) or
- U11300-115 3B NET/log™ (115 V, 50/60 Hz)

Cord, 100 m
100 m length of hemp string, black, rolled onto bobbin.

U8613283



U8613283

Experiment Topics:

- Regular movements and movements with uniform acceleration
- Newton's equations of motion
- Laws on the conservation of momentum and energy
- Elastic and inelastic collisions
- Motion on an inclined air track



Advantages

- Track cannot bend (on stable support with U-shaped profile)
- Length of track 1.9 m
- Sliders move with almost zero friction

Air Track

Track with square profile and 2 gliders for investigating frictionless linear motion. Mounted on a robust U-shaped base resting on three feet that can be adjusted to ensure horizontal alignment. The air is blown in from the front and escapes through small air outlets arranged in 2 rows along the track. This allows for practically frictionless movement of the gliders on the triangular track with no tilting. With millimetre tape measure.

Material:	Anodised aluminium
Total length:	2.00 m
Working length:	1.90 m
Maximum deviation from straight line over complete length:	0.03 mm
Track profile:	Square, 63x63 mm ²
Thickness of walls:	3 mm
Separation of air outlets holes:	20 mm
Base profile:	U-shaped profile
Width of base:	100 mm
Height of base:	50 mm
Wall thickness of base:	5 mm

Contents:

- 1 Air track on U-shaped base profile resting on three feet
- 2 Gliders made of black anodised aluminium with 4-mm holes to accommodate velocity flags and other accessories, plus pins at the sides to hold additional weights, mass: 170 g, length: 125 mm
- 4 Additional 50 g weights
- 1 Velocity flag with plug for interrupting light barriers, mass: 10 g, width: 100 mm
- 2 Velocity flags with plug for interrupting light barriers, mass: 5 g, width: 25 mm
- 3 Forks with plugs and rubber bands for catapulting gliders and investigating elastic collisions, mass: 10 g
- 3 Plates with plugs for investigating elastic collisions, mass: 10 g
- 1 Needle with plug for investigating inelastic collisions, mass: 10 g
- 1 Small tube with plug and plastic filling for investigating inelastic collisions, mass: 10 g
- 1 Hook with plug for attaching a thread with accelerating weights on the end, mass: 10 g
- 1 Pulley for frictionless deflection of accelerated masses
- 1 Set of screws and tools for assembling air track
- 1 Manual

U20610

Additionally required:

- U15425-230 Air Flow Generator (230 V, 50/60 Hz)**
or
U15425-115 Air Flow Generator (115 V, 50/60 Hz)

Additionally recommended:

- U20611 Electromagnetic Launch Apparatus**
U20612 Switch Box
U8557450 Set of Hook Weights and Thread



U15425-230
U15425-115

Air Flow Generator

Fan allowing continuous adjustment of air flow. Includes a hose.

- Hose length: approx. 1.5 m
- Power consumption: max. 1100 W
- Dimensions: 300x180x170 mm³
- Weight: 4.4 kg

Air Flow Generator (230 V, 50/60 Hz)

U15425-230

Air Flow Generator (115 V, 50/60 Hz)

U15425-115

Electromagnetic Launch Apparatus

Used along with a catapult assembled from a fork and rubber band included in the air track set, the launch apparatus imparts uniform, reproducible launch momentum to a glider which is dependent on the tension in the rubber band. It consists of an iron core, a solenoid coil and an armature. The iron core is attached to the end of the air track where it provides a mount for the coil. The glider is connected to the coil via the armature and catapult. When the current is interrupted, the tensed rubber band imparts energy to the glider. A switch box (U20612) is used to activate the system.

- Iron core: 20x20x51 mm
- Coil: 400 turns
- Power supply: 8 V DC

U20611

Additionally recommended:

U20612 Switch Box



U20612

Switch Box

Control unit which is used in conjunction with the electromagnetic launch apparatus to shut off the current and simultaneously send a signal to a connected counter/timer.

Power supply: 8 V DC

U20612

Set of Hook Weights and Thread

Set of propulsion weights and thread for acceleration of sliders on air-cushion track. Consisting of 3 S-shaped hooks, 1 g, 5 S-shaped hooks, 2 g, and 1 roll of sewing thread.

U8557450



U8557450



U20611

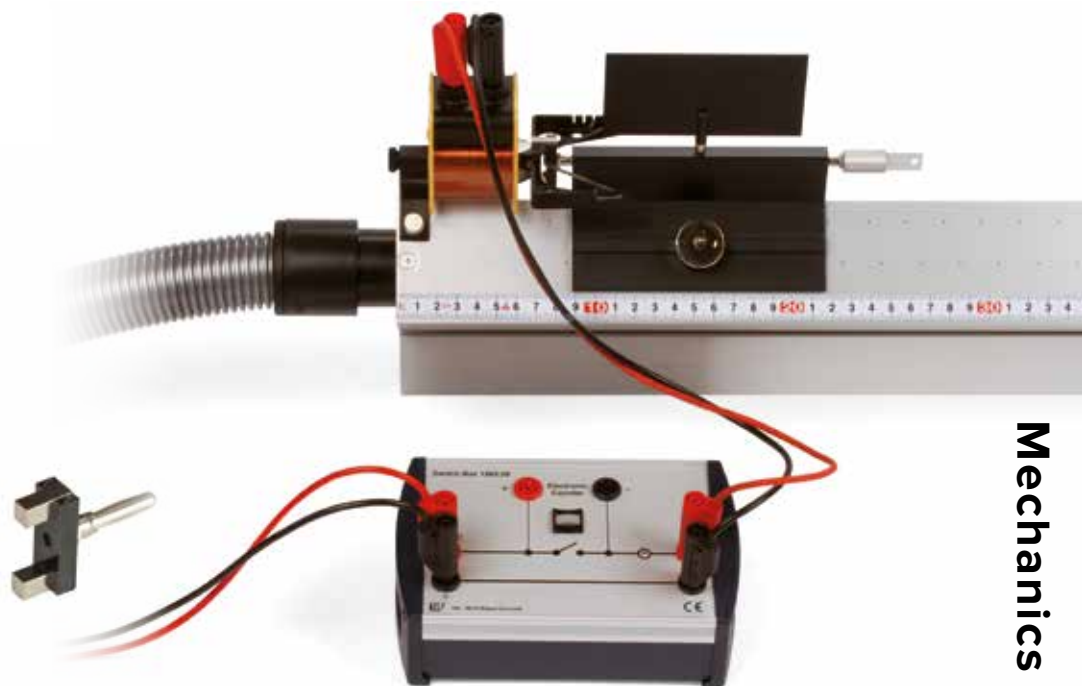

Experiment Topics:

- Newton's equations of motion
- Conservation of momentum and energy
- Elastic and inelastic collisions between equal and different masses
- Harmonic motion and coupled harmonic motion
- Trajectories
- Magnetic repulsion

! Advantage

- Numerous experiments can be carried out without the need for additional accessories

Air-Cushion Table

The air-cushion table possesses a flat glass surface serving as a base for recording paper and carbon paper. Compressed air is supplied to the pucks via light hoses. The air emerges from the bottom of the pucks, making them hover over the recording paper. The motion of the pucks is traced by means of spark recording. The air hoses contain thin metal chains via which a connection to the spark generator is established. The sparks jump over from a contact in the centre of the puck, leaving marks on the recording paper. As the pucks weigh 550 grams, their motion is not affected by the hoses or the attached spark wire.

Contents:

- 1 Experiment table with a glass surface, 580x580 mm²
- 1 Spark generator with a footswitch
- 1 Compressor with a hose
- 2 Steel pucks, 75 mm diam., 550 g
- 2 Puck collars with velcro fastener
- 2 Springs
- 1 Auxiliary puck weight, 150 g
- 1 Edge pulley, 45 mm diam.
- 1 Centre rod with sucker
- 1 Set of plotter paper
- 1 Set of special carbon paper
- 1 Operating manual

Air-Cushion Table (230 V 50/60 Hz)

U405002-230

Air-Cushion Table (115 V 50/60 Hz)

U405001-115

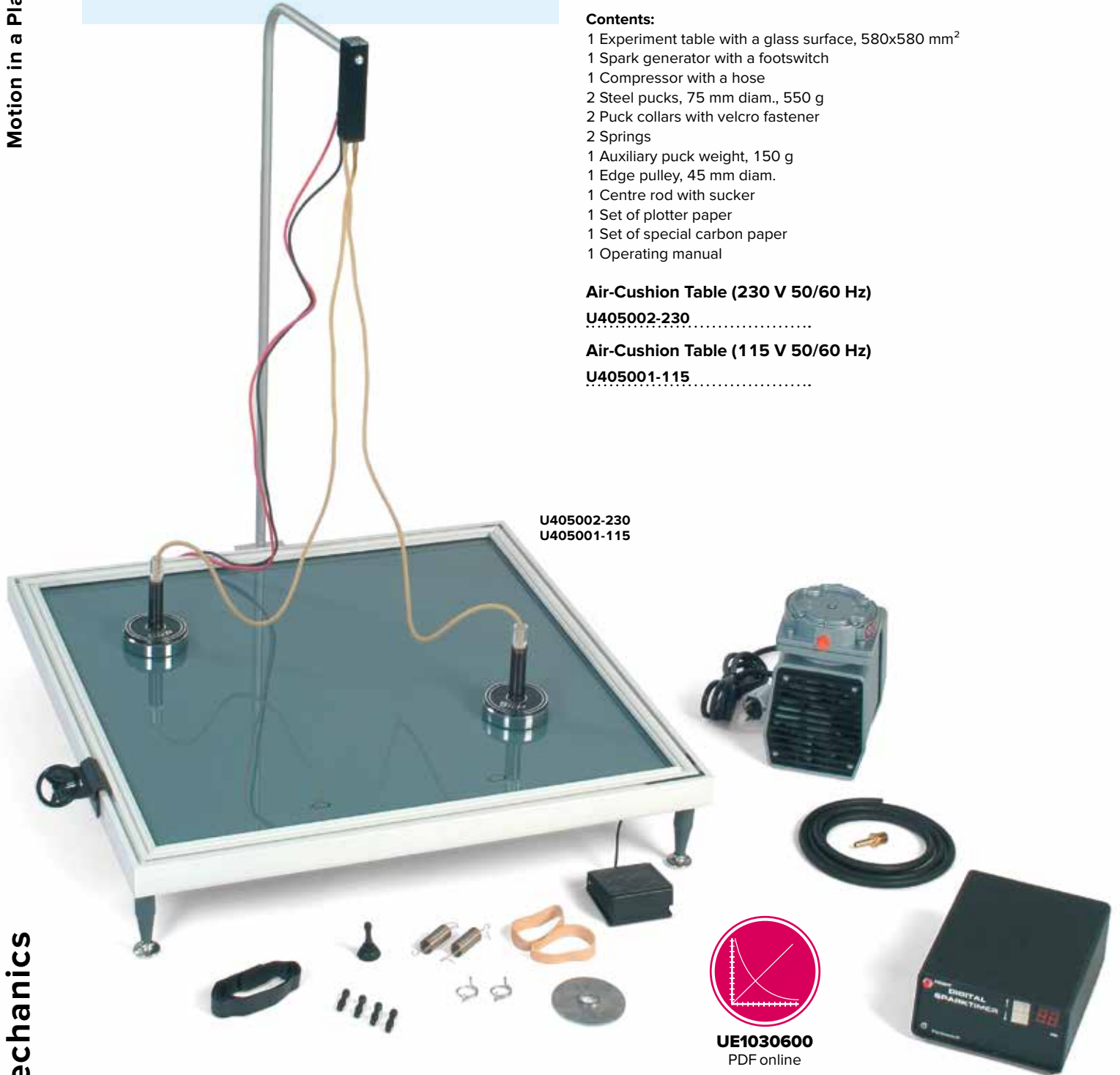

U405002-230
U405001-115

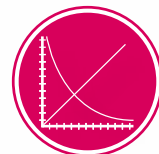

UE1030600
PDF online



U40513

U40514

Acrylic Puck

Acrylic puck for air-cushion table, for use as a second very light puck to demonstrate collisions between unequal masses. A steel puck is hardly deflected at all on collision with an acrylic puck.

Diameter: 75 mm
Weight: 90 g

U40513

Aluminium Puck

Aluminium puck for air-cushion table, for use as a second very light puck to demonstrate collisions between unequal masses.

Diameter: 75 mm
Weight: 210 g

U40514

Pair of Magnetic Pucks

A pair of pucks with extremely powerful magnets positioned such that the pucks repel each other. Intended for performing contactless collisions on the air-cushion table.

U40515

Puck Guide

Long acrylic rod with an internal spring which can be clamped between the inner edges of the air-cushion table. Intended to guide pucks for the purpose of recording harmonic oscillations.

Length: 590 mm

U40510



U40515



U40510

Set of Plotter Paper

100 sheets of printer paper for making pen plots in conjunction with an air-cushion table.

Dimensions: 510x580 mm²

U405121

Additionally required:

U405161 Set of Special Carbon Paper

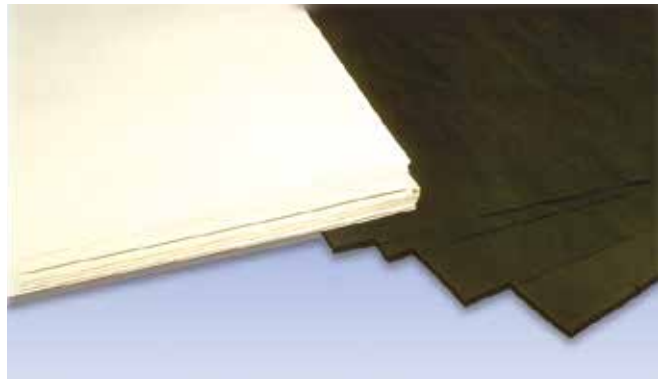

U405121

U405161

Set of Special Carbon Paper

10 sheets of carbon paper.

Dimensions: 550x550 mm²

U405161

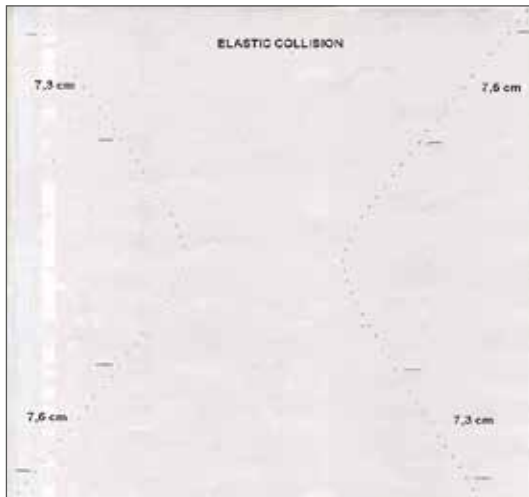

Document your experiments with the air cushion clearly with the aid of the paper sets U405121 and U405161.

Example:
Elastic collision



Measuring acceleration due to gravity

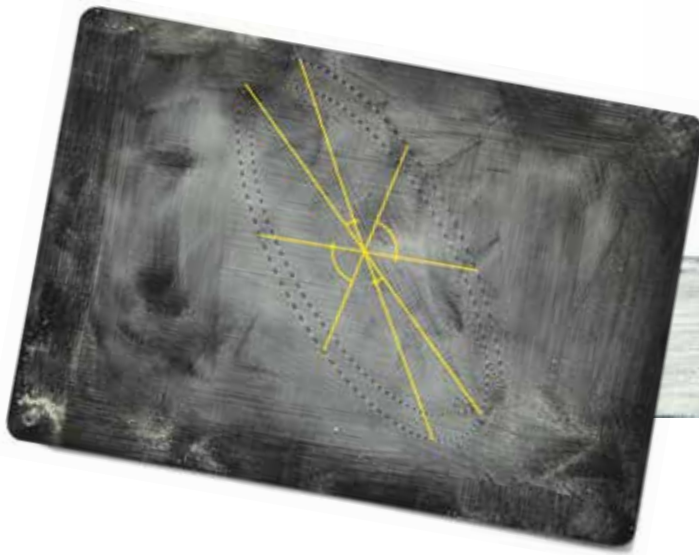

Plotting Movements in a Plane Using Powder Tracing

A plotting electrode slides over a plane counter electrode that is insulated and covered in powdered sulphur. An AC voltage across the two electrodes results in the sulphur powder being attracted or repelled depending on the

polarity of the plotting electrode. A trace thus appears in the powder with ridges that are formed at constant intervals of time. The distance between the ridges reflects the speed of the plotting electrode.

Pair of Elastic Balls with Plotting Electrode

Pair of balls with identical mass and sliding plotter electrode for experiments on elastic collisions that can be demonstrated by means of powder tracing. Made of red plastic with metal ball chain.

Diameter: 70 mm each
Weight: 300 g each

U8405630

Additionally required:

U8400870 Equipment Set for Powder Tracing



U8405630

Pendulum with Plotting Electrode

Cylindrical pendulum bob with sliding plotter electrode for experiments to confirm Kepler's law governing areas covered by a body subject to a central force that can be demonstrated by means of powder tracing.

Steel, with metal ball chain.

Dimensions: 60 mm x 40 mm Ø
Weight: 500 g

U8405640

Additionally required:

U8400870 Equipment Set for Powder Tracing

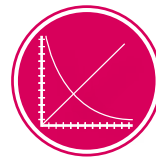

UE1030700
PDF online



U8405640

Equipment Set for Powder Tracing

Set consisting of an insulated plate with 4-mm connector socket, a pulse generator and a transformer with two 4-mm plugs for its secondary winding, 35 g of powdered sulphur and a flat brush.

Transformer: Safety isolating transformer, short-circuit proof
Output voltage: 115 V – 230 V, safe to touch
Protective resistance: 1 MΩ
Plate dimensions: 390x270 mm²

U8400870



U8400870

Advantages

- Easy to set up
- Precise measurement of time with no systematic errors
- Height of fall can be set to the nearest millimetre
- No searching for lost balls

Free-Fall Apparatus

Apparatus for measuring the time it takes for a ball to fall a certain distance using a digital timer. Very easy to set up and use but nevertheless highly accurate. Includes 3 steel balls. A micro-magnet holds the ball in its start position. Three contact pins under the release mechanism ensure that the start position of the ball can be reproduced and act as the contacts of a switch that opens when the ball is released, thus triggering the beginning of the timing measurement. When the ball strikes the contact plate at the bottom, the timer is stopped. The ball is also held firmly on the plate so that it does not bounce. The height through which the ball drops can be adjusted to a fraction of a millimetre and read off a scale on the column.

Height scale: 20 – 960 mm

Scale divisions: 10 mm

Scale precision: 0.2 mm

Balls: Steel, 16 mm diam.

Dimensions: 200x130x1000 mm³ approx.

Weight: 1.6 kg approx.

U8400830

Additionally required:

U8533370-230 Millisecond Counter (230 V, 50/60 Hz)

or

U8533370-115 Millisecond Counter (115 V, 50/60 Hz)

U13811 Set of 3 Safety Experiment Leads for Free-Fall Experiments

Set of 3 Steel Balls

Spare balls for the free-fall apparatus (U8400830), launcher S (U8400930) and marble in a bowl (U8498293).

Diameter: 16 mm

U8400735



U8400735

Holder for Light Barrier

Holder to allow a light barrier (U11365) to be used with the free-fall apparatus (U8400830).

U8557210



U8557210

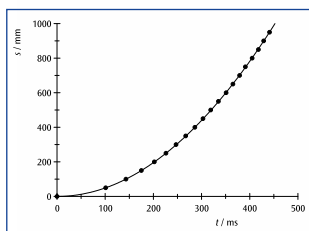

Time-displacement diagram for free fall

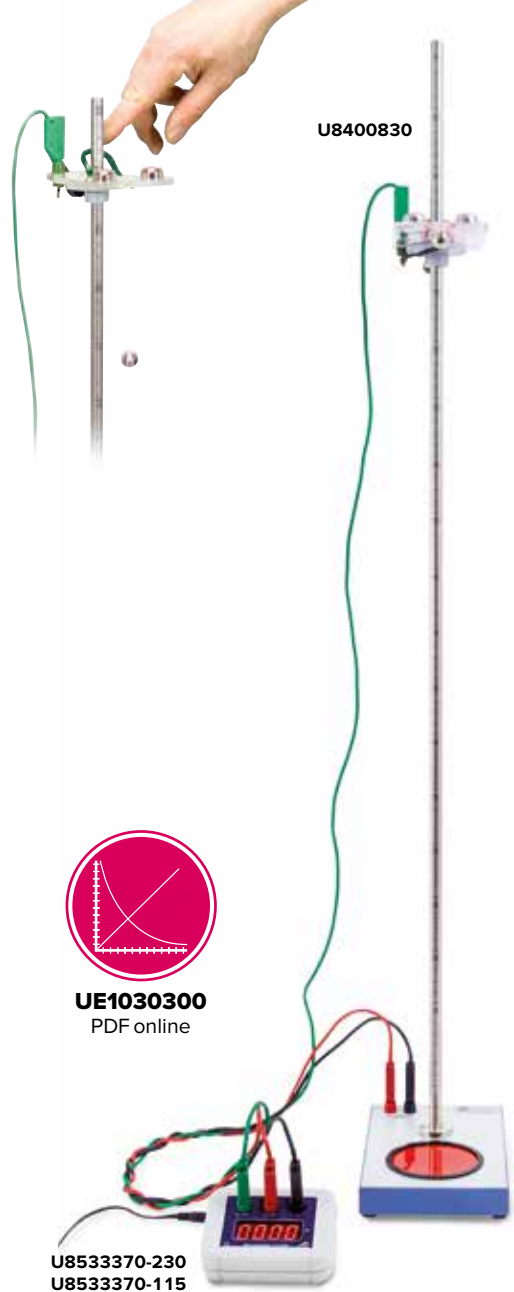

U8400830

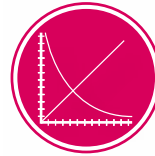

UE1030300
PDF online

U8533370-230
U8533370-115

Free-Fall Tube (Guinea and Feather Apparatus)

This glass pipe can be evacuated to compare the free falling characteristics of different objects in a vacuum. A cork, duck feathers and plastic parts are included as falling objects.

Length: approx. 800 mm

Diameter: 36 mm diam.

Hose nipple: 10 mm

Weight: approx. 1 kg

U8422090

Additionally required:

U34010 Rotary-Vane Vacuum Pump, One-Stage

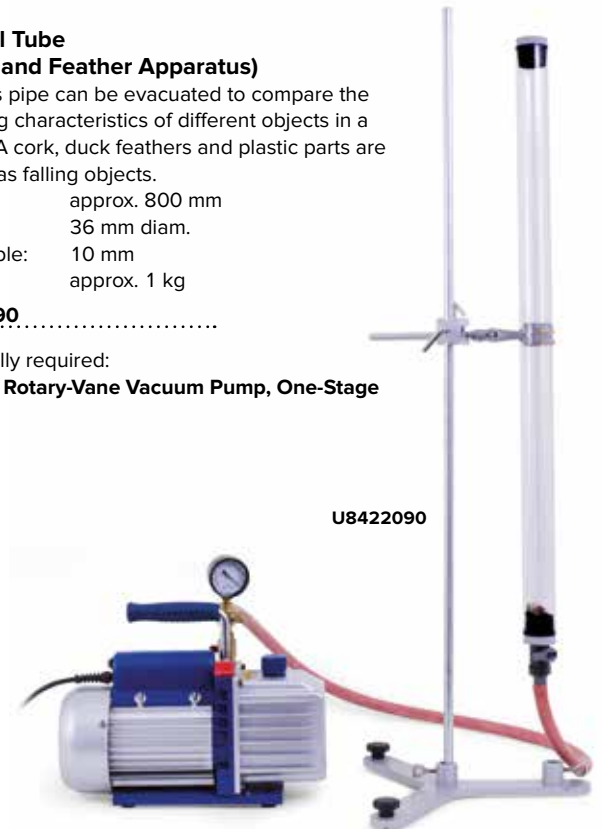

U8422090

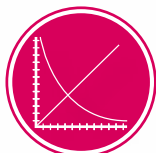

UE1030400
PDF online



Advantages

- Three reproducible launch speeds
- Continuous adjustment of launch angle
- Constant height of trajectory, independent of angle setting
- Balls launched with no rotational spin

Projectile Launcher

Experimental equipment for the quantitative investigation of projectile laws: vertical horizontal and angled launch, recording of flight trajectories depending on launch angle and projectile range. Three different reproducible launch speeds, continuously adjustable launch angles, constant height of trajectory at various angles since the launch point is coincident with pivot point of the cannon. Projectile is launched with almost no spin. The encapsulated design and the use of spherical plastic projectiles ensure that experiments are safe. The launcher is attached to a table via clamp (U10361) or can be used in conjunction with ballistic pendulum (U10362).

Horizontal projectile range (Launch angle 45°): 1.1 m, 2.3 m and 4.5 m
 Launch angle: 0° – 90°
 Reproducibility at 45°: standard deviation less than 1%
 Standard deviation of launch ranges: < 1%
 Diameter of projectiles: 25 mm
 Mass of projectiles: 7 g
 Dimensions: 205x65x60 mm³ approx.
 Mass: 480 g approx.

Contents:

- 1 Launcher
- 3 Plastic projectile balls
- 1 Ramrod
- 1 Wing nut M8x20

U10360

Additionally required:

- U10361 Clamp for Projectile Launcher**
- or
- U10362 Ballistic Pendulum**
- Protective Goggles**

Additionally recommended:

- U10363 Photo Gate Holder for Projectile Launcher**
- U11365 Photo Gate**

Experiment Topics:

- Vertical, angled and horizontal launch
- Recording of the trajectory with an angled launch
- Determination of range and height from the projection angle
- Determination of launch speed from the range and height
- Determination of launch speed using a ballistic pendulum
- Elastic and inelastic collisions

Clamp for Projectile Launcher

Table clamp for Projectile Launcher (U10360) made of anodized aluminium.

Span: 10 mm – 65 mm
 Dimensions: approx. 150x70x80 mm³
 Mass: approx. 710 g

U10361

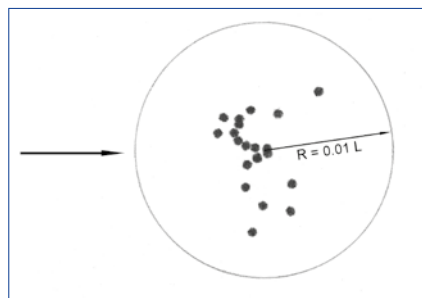

Typical results for measurement of 20 shots. L = range.

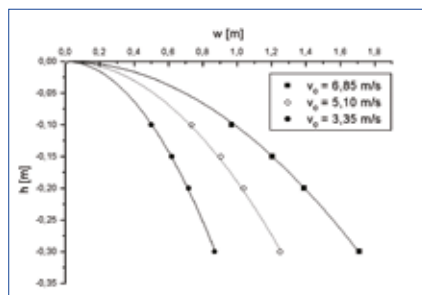

Horizontal launch: projectile height as a function of the projectile distance

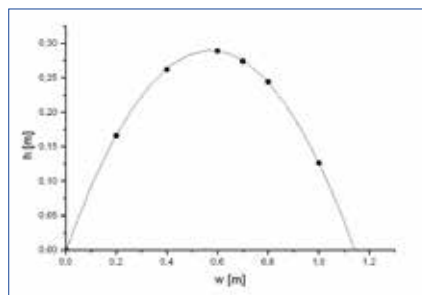

Oblique launch: projectile height as a function of the projectile distance (launch angle: 45°)

Ballistic Pendulum

Accessories for the (U10360) launcher for use in experiments on elastic and inelastic collision or to be used as a holder for experiments on trajectory. The speed of the balls as measured in launcher experiments or pendulum experiments agree to within approximately $\pm 3\%$. Additional weights can be used to investigate how pendulums behave with differing angles of deflection at the same speed. For experiments investigating trajectories, the launcher can be set to 5 different launch heights 5, 10, 15, 20 and 30 cm when it is attached to the rear of the ballistic pendulum.

- Height of pendulum: 370 mm
- Extra weights: 17.5 g each
- Base plate: 130x130 mm²
- Span of bench clamp: 10 – 65 mm
- Mass: 2.1 kg

Contents:

- 1 Ballistic pendulum with table clamp
- 2 Extra weights

U10362

Additionally required:
U10360 Projectile Launcher



Photo Gate Holder for Projectile Launcher

Holder for mounting the photo gate (U11365) at the exit of the projectile launcher (U10360).

U10363

Set of 3 Steel Balls

Spare balls for the free fall apparatus (U8400830), launcher S (U8400930) and marble in a bowl (U8498293).

Diameter: 16 mm

U8400735

Launcher S

Experimental apparatus for studying vertical and horizontal trajectories as well as trajectories starting at intermediate angles. Also demonstrates the independence of the horizontal and vertical components of motion (for projectiles). Provides for three different launch velocities. Angle of launch can be adjusted to any arbitrary angle and read off from a protractor scale with a plumb line. The projectile ball is held in place by a magnet until the moment of launch so that the height of the trajectory is independent of the launch angle. When a projectile is launched, a second ball can be released simultaneously from the other side of the launcher that then descends in free fall. The latter should strike the floor at the same time as the projectile if the launch angle is horizontal.

- Launch angle: 0° – 90°
- Maximum range: 4 m
- Projectile diameter: 16 mm
- Projectile weight: 17 g
- Diameter : 280x90x90 mm³ approx.
- Total weight: 950 g approx.

U8400930

Additionally required:
U15002 Stainless steel rods, 470 mm (2x)
U13260 Table clamps (2x)
Protective goggles



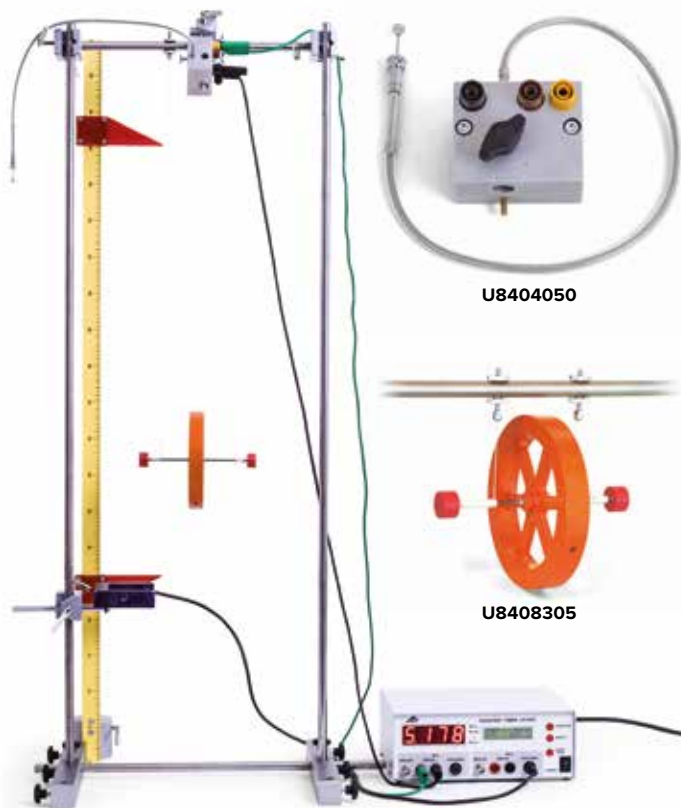

Measurement of fall time

Trigger Device for Maxwell's Wheel

Mechanic start device for triggering a well defined start instant for Maxwell's wheel. With 4-mm sockets for connecting to the start input of the digital counter. Triggering via Bowden cable.

Hole for stand rod: 10 mm diam.

Dimensions: 60x50x50 mm³ approx.

Mass: 260 g approx.

U8404050

Maxwell's Wheel

Spoked wheel with large moment of inertia for demonstrating conservation of energy in the conversion of kinetic energy to potential energy and vice versa. Includes suspending rod and adjustable suspension mechanism. The rotating axle is held in a horizontal position by two strings attached to a suspending rod and is moved upward by winding in the strings. If the equipment is released from its wound in position, the spoked wheel acquires kinetic energy on the way down, which can be seen by the constant increase in its speed of rotation. Two stops on the ends of the axle prevent the wheel from spinning free. At the lowest point when the strings are fully unwound, they start rewinding around the axle and the wheel rises upward again, losing its kinetic energy as it gets higher. To measure the inertial force during acceleration, the whole apparatus complete with stand is placed on a set of scales.

Moment of inertia: 10 kg cm² approx.

Diameter of wheel: 130 mm approx.

Mass of wheel: 370 g approx.

Suspending rod: 370 mm x 12 mm diam.

U8408305

Additionally recommended:

U15004 Stainless Steel Rod 1000 mm (2x)

U8557440 Stand with H-Shaped Base

U13255 Universal Clamp (4x)

U8611461 Stainless Steel Rod 280 mm

U8404050 Trigger Device for Maxwell's Wheel

U11365 Photo Gate (2x)

U8533341-230 Digital Counter/Timer (230 V, 50/60 Hz)

or

U8533341-115 Digital Counter/Timer (115 V, 50/60 Hz)

**Free Fall and Horizontal Launch Equipment**

Equipment for demonstrating the independence of the horizontal and vertical components of motion (for projectiles). A launching rail with returning spring is mounted on a wooden base. Two steel balls are used as test bodies. Upon triggering, one ball starts to fall downwards and simultaneously the other is launched horizontally. Both balls hit the ground at the same time. Two holes in the base plate are provided for storing the balls.

Ball diameter: 15 mm

Dimensions: 200x120x30 mm³ approx.

Mass: 230 g approx.

U119831

Atwood's Machine

Experiment for studying motion under constant acceleration, demonstrating Newton's second law and determining the acceleration due to gravity g . Includes an aluminium stand for affixing to a wall. A string with weights at both ends is passed over a rotating pulley. The set-up undergoes relatively slow but constant acceleration if the weights are slightly different. This motion is initiated by a tug on one string and stops when the dropping weight strikes a movable platform. To show the rotation of the pulley, it is divided into 20 segments of equal angle. It can easily be removed to measure its moment of inertia.

Axis: Mounted on ball bearing

Diameter of pulley: 152 mm

Thickness of pulley: 10 mm

Weights: 150 g each

Slotted weights: 1x 5 g, 2x 2 g, 1x 1 g each

U40550

Additionally required:

U40801 Mechanical Stopwatch, 15 min



U40550

Marble in a Bowl

Concave transparent acrylic body with spherical curvature. A rolling ball oscillates inside the concavity about its rest position like a mathematical pendulum does. The radius of curvature is equivalent to the length of a normal pendulum. Includes three steel balls.

Diameter of balls: 16 mm
 Radius of curvature: 200 mm
 Diameter: 140 mm

U8498293

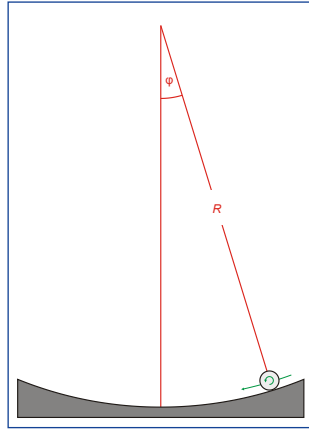

U8498293

Set of 6 Steel Balls

Ball bearings made of hardened and polished steel. Can be used with a guide rail for experiments on elastic collisions or in combination with watch glasses to demonstrate various states of equilibrium. Rail not included.

Diameter: 30 mm each
 Weight: 110 g each

U15014



U15014

U17150

Transfer of energy and momentum as a result of collision.

Experiment 1: Investigation of motion and collisions in a single dimension

Equipment:
 U15014 Set of 6 Steel Balls
 U17150 Optical Bench U, 1200 mm

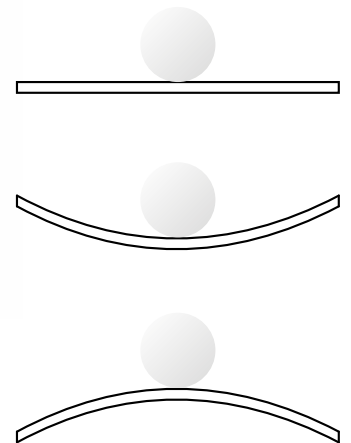

Experiment 2: Stable, unstable and neutral equilibrium

Equipment:
 U15014 Set of 6 Steel Balls
 U14200 Set of 10 Watch Glass Dishes, 80 mm
 U14201 Set of 10 Watch Glass Dishes, 125 mm
 U21885 Plane Mirror



U21885

Neutral equilibrium

U14200

Stable equilibrium

U14201

Unstable equilibrium

Experiment Topics:

- Rotational motion: uniform and under constant acceleration
- Newton's equations of motion for rotational motion
- Moment of inertia and torque
- Moment of inertia as determined by experiment
- Simple harmonic motion of rotating objects

Rotating System on Air Bed

Apparatus for investigating frictionless rotation. A small rotating disc with a protractor scale supports a cross bar to which weights can be attached. The disc is supported by a bed of air in which its axis is centred. A driving weight is suspended from a hook at the end of a string that is passed over a single pulley on one side and a multiple pulley on the other. The rotation is very slow and can be measured using a stopwatch by hand. Alternatively, a digital timer may be used. This can be started by a mechanism that is supplied with the kit and halted by a signal from a laser reflection sensor when the wheel passes through angle zero.

Protractor scale:	0 – 360°
Scale divisions:	1°
Length of cross bar:	ca. 440 mm
Radii of perforations:	30 – 210 mm
Separation of perforations:	20 mm
Radii of multiple pulley:	5.0 mm/10.0 mm/15.0 mm
Moment of inertia of disc with cross bar:	0.9 g m ² approx.
Maximum moment of inertia:	7.1 g m ² approx.

Minimum driving torque: 0.05 mN m approx.
Maximum driving torque: 0.60 mN m approx.

Contents:

- 1 Air bed
- 1 Rotating disc with cross bar
- 1 Multiple pulley
- 1 Release mechanism
- 2 S-shaped hooks 1.00g
- 1 S-shaped hook 2.00 g
- 1 Set of weights (2x 12.5 g, 2x 25 g, 2x 50 g)
- 1 Compressor for connection to mains
- 1 Silicon tubing with by-pass valve (not illustrated)
- 1 Pulley
- 1 Stand rod with 3 securing screws and 2 screws for levelling
- 1 Stand rod with 2 securing screws
- 1 Stand rod, 250 mm
- 1 Levelling disc
- 1 Roll of thread

Rotating System on Air Bed (230 V, 50/60 Hz)

U8405680-230

Rotating System on Air Bed (115 V, 50/60 Hz)

U8405680-115

Additionally recommended:

U8533380 Laser Reflection Sensor

U8533341-230 Digital Counter/Timer (230 V, 50/60 Hz)

or

U8533341-115 Digital Counter/Timer (115 V, 50/60 Hz)

U8405690 Supplementary Kit for Rotating System on Air Bed



Supplementary Kit for Rotating System on Air Bed

Supplementary kit for the rotating system on air bed (U8405680-230/ U8405680-115) for investigating frictionless rotational motion and oscillations using a large rotating disc. On the underside of the large disc is an angle grid that can be used to provide triggers to a laser reflection sensor (U8533380) if the rotation is to be recorded with the help of the 3B NETlog™ interface unit.

Typical oscillation periods: 20 s approx. to 2 mins approx.

Moment of inertia of large disc: 2.2 g m² approx.

Contents:

- 1 Large disc with protractor scale, 350 mm
- 1 Scaffold stand
- 1 Cross sleeve
- 1 Set of coupling springs with magnet (1 N, 2 N, 5 N)

U8405690

Additionally recommended:

U8533380 Laser Reflection Sensor and

U8533341-230 Digital Counter (230 V, 50/60 Hz) or

U8533341-115 Digital Counter (115 V, 50/60 Hz) or

U11300-230 3B NETlog™ (230 V, 50/60 Hz) or

U11300-115 3B NETlog™ (115 V, 50/60 Hz)



Measuring the period of oscillation and determining the moment of inertia

Watt's Governor

Symmetrical pendulum system on an axle, for demonstrating centrifugal force. The pendulum arms are held in a state of rest by a coil spring. Depending on the rotational speed, they are lifted against the force of gravity as the axle turns. This can then be used to control the speed of a steam engine.

Rotation diameter: 350 mm
 Height: 250 mm
 Diameter of axle: 10 mm

U8403115

Additionally required:

U10375 Experiment Motor with Gearbox

U13260 Table Clamp

U33020-230 DC Power Supply 0 – 20 V, 5 A (230 V, 50/60 Hz)

or

U33020-115 DC Power Supply 0 – 20 V, 5 A (115 V, 50/60 Hz)

Additionally recommended:

U40160-230 Digital Stroboscope (115 V, 50/60 Hz)

or

U40160-115 Digital Stroboscope (230 V, 50/60 Hz)



U8403115

Experiment Motor with Gearbox

Experiment motor for universal use in experiments on rotational motion, e.g. for experiments using the Watt's governor (U8403115). Can also be used as a generator in conjunction with the included hand crank. Robust clockwise and counter-clockwise rotating IDC motor with epicyclic gearbox and quick-action chuck in a tough anodized aluminum casing with removable and adjustable stainless steel stand rod. Can also be mounted on the clamp for the projectile launcher (U10361). Speed of rotation is adjusted by altering the supply voltage. Adjustable torque. Includes 3 belt pulleys of different diameters on a mounting axle.

Speed without load: approx. 480 rpm at 12 V
 Speed sensitivity: approx. 40 rpm per V
 Span of chuck: 0.8 to 10 mm
 Stand rod: 12 mm diam.
 Pulleys: 10 mm diam., 20 mm diam., 40 mm diam.
 Axle: 10 mm diam.
 Drive belt: 130 mm diam. x 4 mm
 Nominal voltage: 12 V DC, 5A
 Connection: via 4-mm safety sockets
 Dimensions: 210x95x60 mm³
 Mass: 1.2 kg

U10375



U8405715

Rotation Apparatus

Rotating apparatus for determining angular acceleration as a function of the torque and for determining the moment of inertia depending on mass and distance from an axis. An axle on agate bearings supports a cross bar to which weights can be attached. The force from a driving weight is conveyed to the axle via a string wrapped around the axle and passed over a pulley and a second multiple pulley on the axle itself.

Length of crossbar: 600 mm
 Radii of multiple pulley: 4.5 mm / 9.0 mm
 Driving weights: 10 g / 20 g / 30 g / 40 g / 50g
 Inertial mass of disc(s): 100 g / 200 g / 300 g
 Dimensions of base plate: 200x140 mm²
 Total weight: 1.3 kg approx.

Contents:

- | | |
|-----------------------------------|------------------------|
| 1 Basic apparatus | 2 Slotted weights 10 g |
| 2 100-g discs | 1 Slotted weight 20 g |
| 2 200-g discs | 1 Pulley |
| 1 Holder for slotted weights 10 g | 1 Roll of string |

U8405715

Additionally recommended:

U40160-230 Digital Stroboscope (115 V, 50/60 Hz)

or

U40160-115 Digital Stroboscope (230 V, 50/60 Hz)



U10375

Contents:

- | | |
|-------------------------------|------------|
| Experiment motor | Hand crank |
| Stand rod with knurled screws | Pulleys |
| | Drive belt |

Additionally required:

U33020-230 DC Power Supply 0 – 20 V, 5 A (230 V, 50/60 Hz)

or

U33020-115 DC Power Supply 0 – 20 V, 5 A (115 V, 50/60 Hz)

Experiment Topics:

- Moment of inertia of a disc
- Torque
- Angular momentum
- Precession
- Nutation

Gyroscope

High quality precision made gyroscope for demonstration as well as for quantitative determination of gyroscopic laws by means of practical experiments. Experiment apparatus with a shaft that can be tilted and rotated while attached to a stand rod. On one side of the shaft there is a disc mounted on dual ball bearings, while on the opposite side there is a movable counterweight for establishing equilibrium. Fine adjustment is performed by thumb screw at the end of the shaft. To generate external torque an additional weight is provided that can also be moved along the shaft. The shaft's angle of inclination can be read from an easily readable scale. A spirit level allows the gyroscope to be adjusted to the horizontal. The disc can be set rotating by hand or by means of a cord. The dual ball bearing system ensures that rotation is nearly frictionless and that rotation continues for lengthy periods of time. The open construction of the gyroscope allows gyroscopic phenomena to be observed easily and clearly.

Scale:	- 40° to + 40°	Mass of
Scale divisions:	1°	additional weight:
Disc:	250 mm diam.	Total weight:
Mass of disc:	1500 g	
Mass of counterweight:	1400 g	

U52006

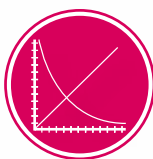

UE1040500
PDF online

U52006



U52010

Gyroscope Accessories

Accessories kit for Gyroscope (U52006) consisting of a gyroscope disc and counterweight. For demonstrating the canceling out of gyroscopic phenomena in the case of two discs rotating at the same speed in opposite directions.

U52010

Bicycle Wheel Gyroscope

Spoked wheel with weighted rim for demonstrating conservation of angular momentum. Simple to use due to small wheel radius and ease of suspension.

Diameter: 500 mm

U450001

Additionally recommended:

U45001 Turn Table

U8724980 Experiment Cord

Gyroscope S

Gyroscope with low-profile, dynamically balanced metal rotor in a Cardan gimbal mount. Ideal for studying gyroscopic stability phenomena, precession and nutation. Also supplied is a pendulum mounting that can be used for investigating the rolling or tipping moment. The set includes plastic Cardan discs, Cardan gimbal mount, pendulum mounting and starting cord.

Dimensions: 170x120 mm² approx.

U8556020



U8556020

Turn Table

Intended for use with the bicycle wheel gyroscope, this rotary platform allows operation on a laboratory stool or as a base surface. Anti-skid design.

Diameter: 300 mm

U45001



U450001

U45001

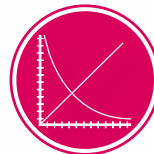
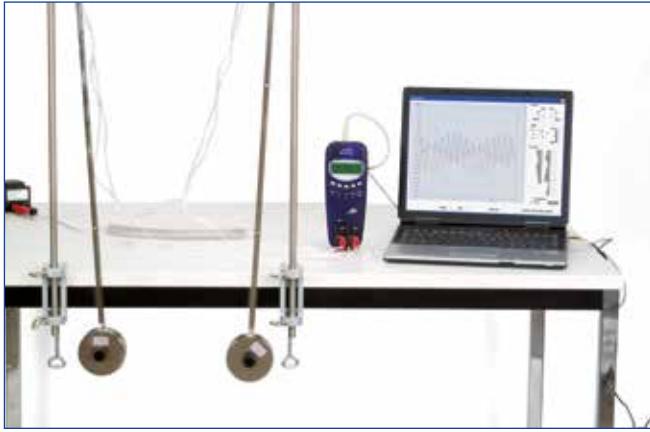

UE1050600
PDF online

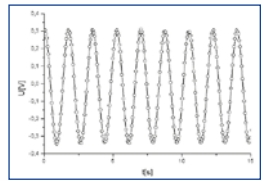

Deflection of the pendulum as a function of time

Advantages

- Low-friction needle bearing
- Electromagnetic angle sensor

Pendulum Rod with Angle Sensor

Pendulum with low-friction pointed bearings and electromagnetic angle sensor for measuring simple harmonic motion of a weighted pendulum with movable weight. Including plug-in power supply. The deflection of the pendulum is detected by a Hall sensor that converts the angle to an electrical signal proportional to the angle so that the oscillation can be recorded using an interface unit, a Y-t plotter or a storage oscilloscope.

Length of pendulum: 1 m
 Mass of pendulum: 1 kg
 Output voltage: ± 5 V
 Output resistance: 500 Ω
 Power supply: 12 – 16 V AC
 Diameter of tube: 10 mm
 Weight: 1,4 kg approx.

Pendulum Rod with Angle Sensor (230 V, 50/60 Hz)

U8404275-230

Pendulum Rod with Angle Sensor (115 V, 50/60 Hz)

U8404275-115

Additionally required:

- U13260 Table clamp**
- U15004 Stainless steel rod, 1000 mm**
- U13255 Universal clamp**

Additionally recommended:

- U11300-230 3B NET/log™ (230 V, 50/60 Hz)**
- or
- U11300-115 3B NET/log™ (115 V, 50/60 Hz)**

Set of 4 Pendulum Bobs

4 balls with securing eyes: made of brass, aluminium, steel and plastic for constructing a mathematical pendulum.

Diameter: 25 mm
 Weights: 71.2 g, 25.2 g, 61 g, 10.5 g

U30035

Additionally required:

- U8724980 Experiment Cord**
- Stand Equipment**

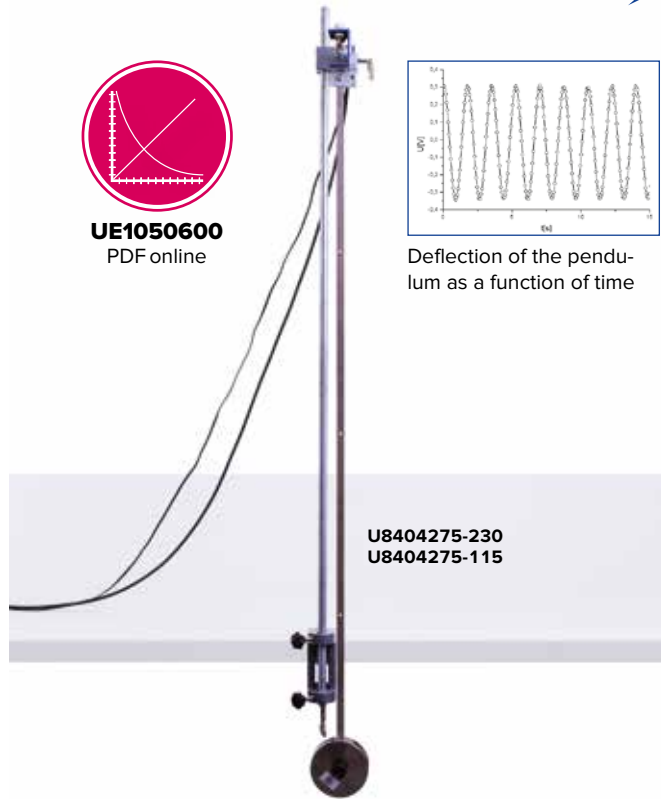

U8404275-230
U8404275-115

Rod Pendulum (not shown)

Rod pendulum with low-friction pointed bearings as per U8404275-230 or U8404275-115 but with no Hall sensor or magnet for detecting angle.

U8404280

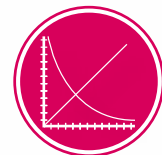

UE1050600
PDF online



Chaotic Pendulum E

A double pendulum made of anodised aluminium for mounting on a rigid wall. Both lengths of the pendulum are manufactured with the utmost precision and rotate, or oscillate, without friction around their axis. The way the movement develops is unpredictable and therefore chaotic. Depending on the initial conditions, the pendulum lengths begin rotate and lose energy due to friction. Once the energy is no longer sufficient, the rotation gives way to oscillation. The motion of each of the pendulums is affected by the other. This means that the rotation of the second length can be transferred to the first, which may provide it with enough energy to rotate again. The chaotic pendulum stops when all the energy has been lost due to friction.

Dimensions: 350x38x52 mm

U8557340

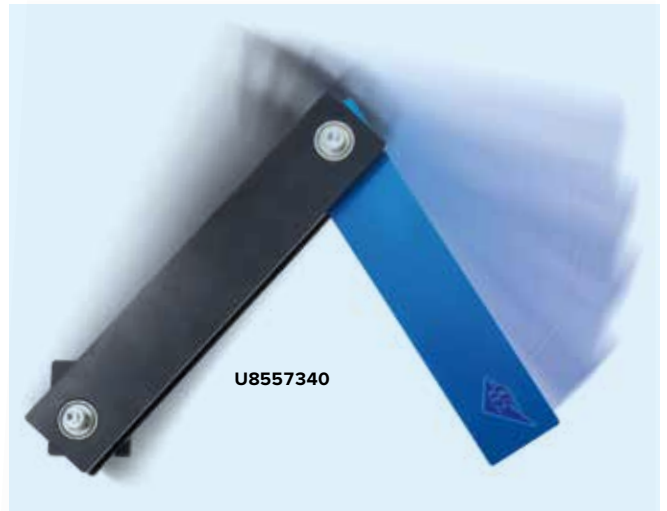

Variable g Pendulum

Pendulum with continuously adjustable plane of oscillation for observing pendulum oscillations where the acceleration due to gravity g can appear to be varied.

Max. length of pendulum: 280 mm

Mass of pendulum: 0.5 kg

Angle of plane

of oscillation: $0^\circ - 90^\circ$

Dimensions: 300x250x550 mm³

Mass: approx. 5 kg

U8403950

Additionally required:

U13271 Stand Base, Tripod, 185 mm

U15002 Stainless Steel Rod, 470 mm

Additionally recommended:

U8403955 Photogate Holder for Pendulum

U11365 Photo Gate

U8533341-230 Digital Counter (230 V, 50/60 Hz)

or

U8533341-115 Digital Counter (115 V, 50/60 Hz)



Photogate Holder for Pendulum

Holder for mounting the light barrier (U11365) with a variable-g pendulum, for which the plane of oscillation can be set at any angle.

U8403955

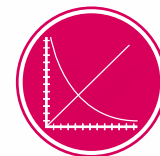

UE1050201
PDF online

U11365

U8533341-230
U8533341-115



Experiment Topics:

- Harmonic oscillations
- Determining unknown masses
- Gravitational mass and inertial mass



Inertia Balance

Inertia balance for determining inertial mass. After the apparatus is calibrated by determining the vibration frequency for objects of known mass, it can be used to determine the unknown masses. The Inertia Balance consists of two metal trays connected by stiff steel spring strips. One tray has 3 holes to hold up to three masses and the other tray may be anchored to a table edge or laboratory bench with the included table clamp.

Length of steel strip: approx. 350 mm
 Masses: approx. 175 g each

Contents:

- 1 Inertia Balance
- 1 Table clamp
- 1 Cord, 1.85 m
- 3 Masses

U30045

Additionally required:
U40801 Mechanical Stopwatch, 15 min

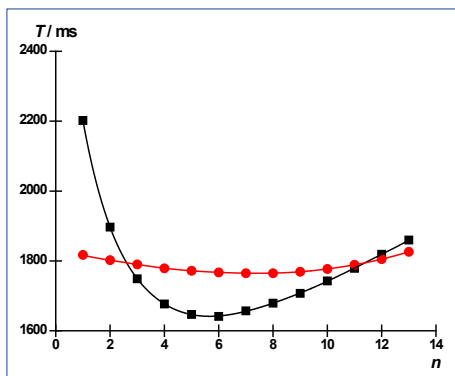

Periods of oscillation around both fulcra as a function of the position of the sliding weight

Experiment Topics:

- Measurement of periods of oscillation of Kater's reversible pendulum for two fulcra
- Adjustment of Kater's reversible pendulum for equal periods of oscillation
- Determination of acceleration due to gravity

new

Kater's Reversible Pendulum

Special form of physical pendulum for determining local acceleration due to gravity g . Pendulum rod with two fulcra plus one sliding and one fixed disc weight for adjusting the period of oscillation. When correctly adjusted, the pendulum will oscillate about both fulcra with the same period of oscillation. The pendulum is suspended from very low-friction needle bearings on a highly stable support. In order to adjust orientation, the support is equipped with two adjustment screws and a spirit level. Includes mounting plate for light barrier.

Height of apparatus with pendulum: 1.25 m approx.
 Length of pendulum rod: 1.2 m
 Separation of bearing points: 800 mm
 Period of adjusted pendulum: 1794 ms when $g = 9.81 \text{ m/s}^2$
 Total weight: 6.3 kg approx.

U8557170

Additionally required:
U11365 Light Barrier
U8533341-230 Digital Counter (230 V, 50/60 Hz)
 or
U8533341-115 Digital Counter (115 V, 50/60 Hz)

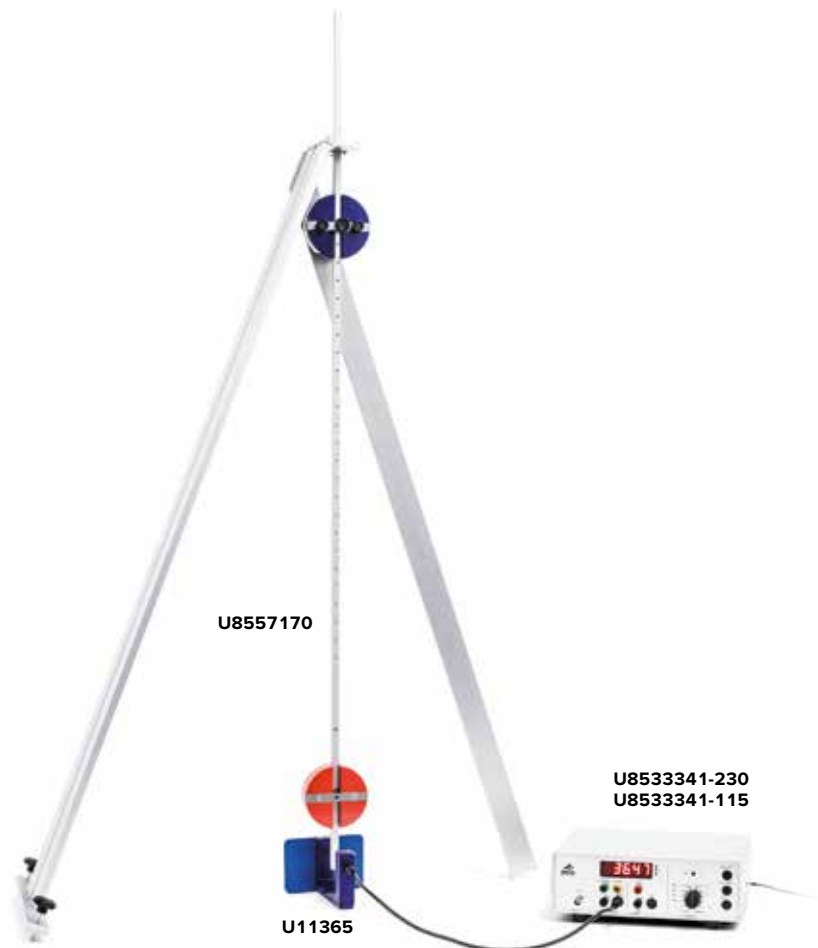

Mechanical Oscillations in a Space-Saving Tabletop Experiment

SW Sensors Set

Set incorporating two dynamometers and an amplifier board for recording and analysing mechanical oscillations using a standard oscilloscope. The dynamometers can be fitted to 10-mm diameter stands or the SW tie bar in order to measure dynamic forces along their axes. The amplifier board converts signals from both dynamometers so that they can be recorded and also evaluates the phase differences between both oscillation signals, outputting them as a DC signal. If the MEC amplifier board is connected to the 2x 50 MHz USB oscilloscope (U112491), it is possible to perform detailed analysis and evaluation of measured signals using the oscilloscope software on a PC.

Dynamometers:

Maximum force: 5 N
 Frequency range: 0.3 – 200 Hz
 Connectors: 3.5-mm jack plugs
 Dimensions: 52x37x26 mm³

MEC amplifier board:

Input sockets: 3.5-mm jack sockets
 Output sockets: BNC
 Dimensions: 65x100x40 mm³

Contents:

2 Dynamometers
 1 MEC amplifier board
 1 Power supply, 12 V AC, 700 mA
 2 HF Patch cords

SW Sensors Set (230 V, 50/60 Hz)

U61023-230

SW Sensors Set (115 V, 50/60 Hz)

U61023-115

Additionally recommended:

U112491 USB Oscilloscope 2x 50 MHz

or

U33070-230 Analogue Oscilloscope 2x20 MHz (230 V, 50/60 Hz)

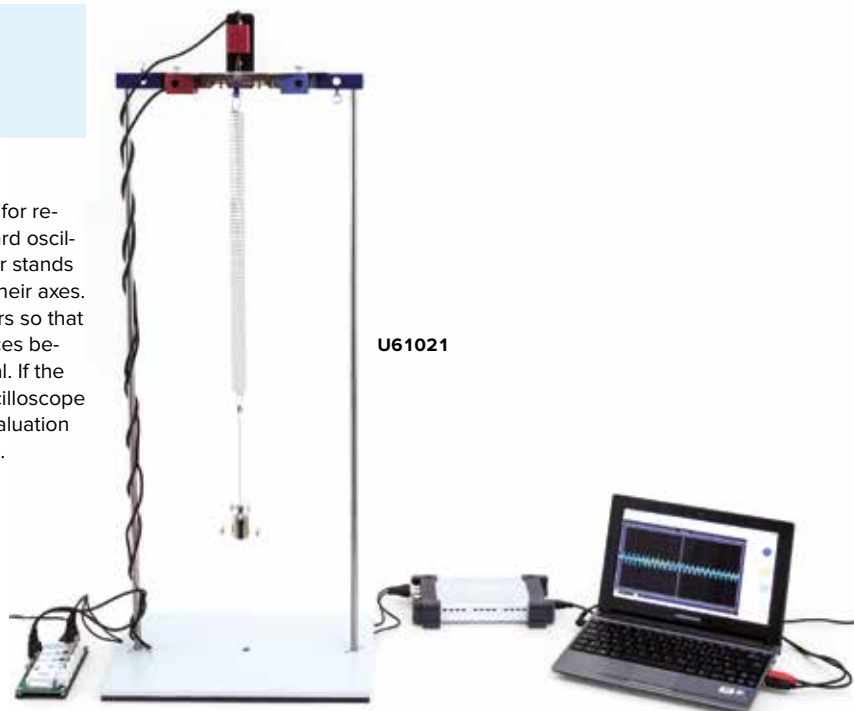

SW Wilberforce Pendulum Set

Set for building a Wilberforce pendulum or a torsion pendulum in a space-saving table-top experiment. Adjustable rotating body for fine adjustment of moment of inertia in order to investigate couples translation and rotation oscillations as per Wilberforce's experiment. Includes components for connecting to dynamometers from the SW Sensors set in order to record and comprehensively analyse oscillations using a standard oscilloscope.

Contents:

1 Spring, 5 N/m
 1 Rotating body
 1 Vertical plate
 1 Body with hook
 1 Spring set B for fitting to dynamometer

U61021

Additionally required:

U61022 SW Stand Equipment Set

Additionally recommended:

U61023-230 SW Sensors Set (230 V, 50/60 Hz)

or

U61023-115 SW Sensors Set (115 V, 50/60 Hz)

U112491 USB Oscilloscope 2x 50 MHz

or

U33070-230 Analogue Oscilloscope 2x 20 MHz (230 V, 50/60 Hz)



U61023-230
 U61023-115

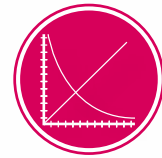

UE1050121
PDF online

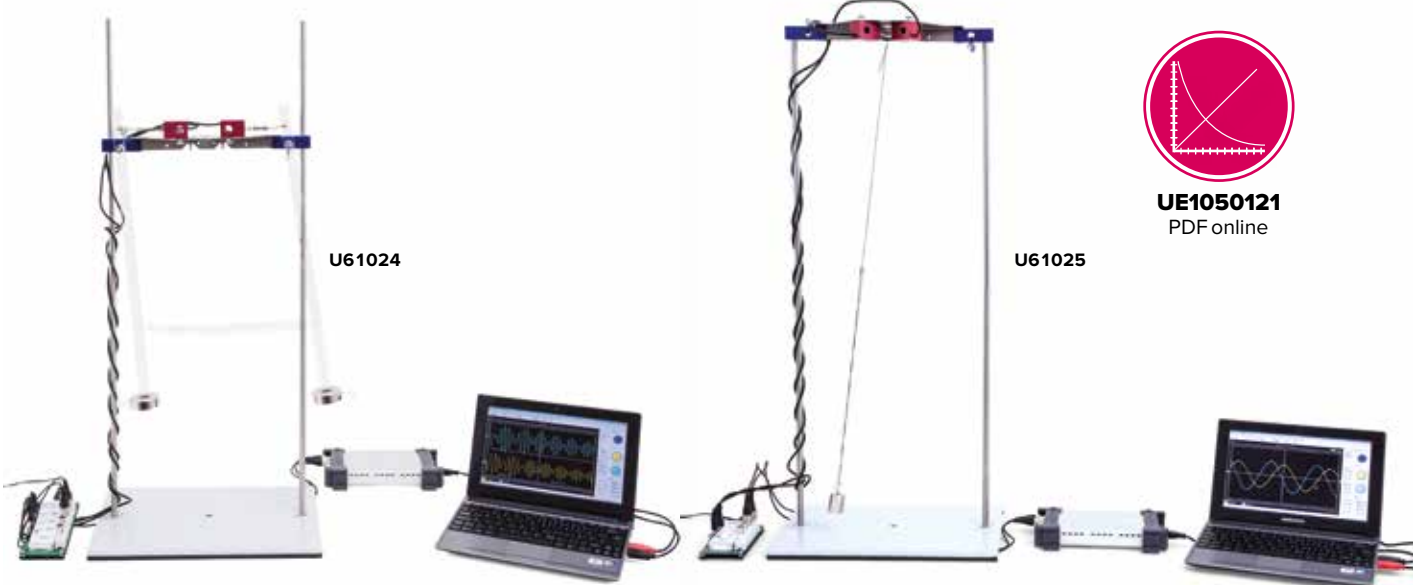

SW Physical Pendulum Set

Versatile set for building a physical pendulum with a moveable weight, a reversing pendulum or a pair of coupled pendulums in a space-saving table-top experiment. Includes components for connecting to dynamometers from the SW Sensors set in order to record and comprehensively analyse oscillations using a standard oscilloscope.

Contents:

- 2 Bearing bars
- 2 Pendulum rods
- 2 Weights, 200 g
- 1 Weight, 150 g
- 1 Acrylic ring
- 1 Spring, 2.5 N/m
- 2 Coupling spring sets C

U61024

Additionally required:

U61022 SW Stand Equipment Set

Additionally recommended:

U61023-230 SW Sensors Set (230 V, 50/60 Hz)

or

U61023-115 SW Sensors Set (115 V, 50/60 Hz)

U112491 USB Oscilloscope 2x 50 MHz

or

U33070-230 Analogue Oscilloscope 2x 20 MHz (230 V, 50/60 Hz)

SW String Pendulum Set

Kit for easy assembly of a string pendulum for comprehensive investigation of simple harmonic motion and chaotic oscillations in a space-saving table-top experiment. Features movable string pulley for setting string lengths and magnetic strips for generating chaotic oscillations. Other components are for connecting to dynamometers from the SW Sensors set in order to record and analyse oscillations with two degrees of freedom using a standard oscilloscope.

Contents:

- 1 String, 100 m
- 1 Weight, 100 g
- 1 Long magnetic strip
- 2 Short magnetic strips
- 1 Spring set A for fitting to dynamometer

U61025

Additionally required:

U61022 SW Stand Equipment Set

Additionally recommended:

U61023-230 SW Sensors Set (230 V, 50/60 Hz)

or

U61023-115 SW Sensors Set (115 V, 50/60 Hz)

U112491 USB Oscilloscope 2x 50 MHz or

U33070-230 Analogue Oscilloscope 2x 20 MHz (230 V, 50/60 Hz)

SW Stand Equipment Set

Stand equipment for easy, understandable and stable assemblies, e.g. for investigating mechanical oscillations and waves using the sensors from the SW sensors set (U61023-230 or U61023-115). Including SW base plate as non-tilting base to accommodate the stand rods, two double clamps and SW tie bar. The SW tie bar serves as multi-function holder for fitting between stand rods on the base plate in order to build set-ups featuring the dynamic force sensors from the SW sensors set.

Base plate: 345x240x16 mm³ approx.

Stand rods: 400 mm x 10 mm dia. approx.

Contents:

- 1 SW Base plate
- 2 Stand rods with internal and external thread
- 2 Stand rods with external thread
- 2 SW Double clamps
- 1 SW Tie bar

U61022

Additionally recommended:

U8611461 Steel Rod 280 mm

U8611460 Steel Rod 400 mm



U61022



U8403000-230
U8403000-115

Experiment Topics:

- Pendulum oscillations
- Rotation of the Earth
- Coriolis force

Foucault Pendulum

Pendulum for qualitative and quantitative demonstration of the rotation of the earth by means of observing the plane of oscillation. To prevent the oscillation taking an elliptical path, the thread upon which the pendulum bob is suspended passes through a Charron ring. The plane of the oscillation is detected with high accuracy by projecting the shadow of the thread onto a protractor scale. The rotation of the plane can thus be identified in a very short period of time. For longer periods of observation, the gradual damping of the oscillation can be compensated for by means of an electromagnetic boost that can be adjusted to an arbitrary value. The apparatus is presented in decorative fashion inside a box with all sides made of and lit from the inside to make for a very eye-catching appearance.

Length of pendulum: 1200 mm

Mass of pendulum: 230 g

Diameter: 38 mm

Vertical alignment: By means of four height-adjustable feet

Angular resolution: 0.1°

Dimensions: 400x400x1400 mm³

Mass: approx. 40 kg

Foucault Pendulum (230 V, 50/60 Hz)

U8403000-230

Foucault Pendulum (115 V, 50/60 Hz)

U8403000-115

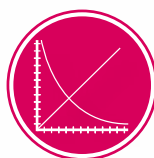

UE1050250

PDF online

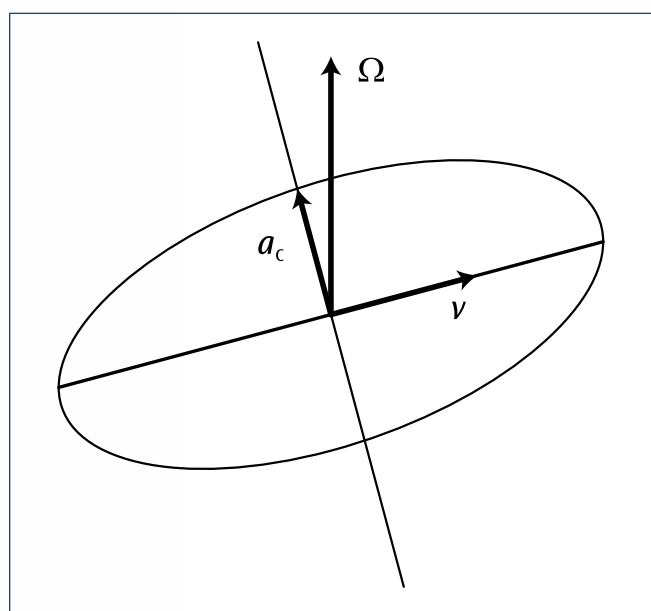

Diagram of Coriolis acceleration

Experiment Topics:

- Free rotary oscillations at various degrees of damping (oscillations with moderate damping, aperiodic oscillations and aperiodic borderline case)
- Forced oscillations and their resonance curves at various degrees of damping
- Phase displacement between the exciter and resonator during resonance
- Chaotic rotary oscillations

Plug-in Power Supply 24 V, 0.7 A

Plug-in power supply for the electric motor used with Pohl's pendulum (U15040). Including cables and two safety plugs on the secondary side.

Output voltage: 24 V, 0.7 A
Length of cables: 1 m

Plug-in Power Supply 24 V, 0.7 A (230 V, 50/60 Hz)

U33200-230

Plug-in Power Supply 24 V, 0.7 A (115V, 50/60 Hz)

U33200-115

Pohl's Torsion Pendulum

For investigating free, forced and chaotic oscillations at various degrees of damping. With slotted scale ring and pointers on resonator and exciter. An electric motor is included for exciting forced oscillations. It features coarse and fine speed adjustment and is coupled via an eccentric wheel. For damping, an electromagnetic eddy brake is used. The equipment can also be used in demonstrations involving projection of shadows.

Natural frequency: approx. 0.5 Hz
Excitation frequency: 0 to 1.3 Hz
Connectors: 4-mm safety sockets
Motor: max. 24 V AC/DC, 0.7 A
Eddy brake: 0 – 2 A DC, 20 V
Scale ring: 300 mm diam.
Dimensions: 400x140x270 mm³
Weight: 4 kg

U15040

Additionally required:

U33020-230 DC Power Supply 0 – 20 V, 0 – 5 A (230 V, 50/60 Hz)

U33200-230 Plug-in Power Supply 24 V, 0.7 A (230 V, 50/60 Hz)

or

U33020-115 DC Power Supply 0 – 20 V, 0 – 5 A (115 V, 50/60 Hz)

U33200-115 Plug-in Power Supply 24 V, 0.7 A (115 V, 50/60 Hz)

U40801 Stopwatch, 15 min

U17450 Analogue Multimeter AM50
Patch Cords

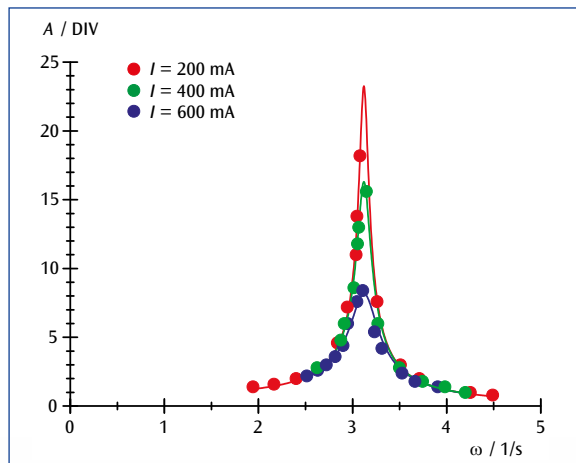

Resonance curve for different degrees of damping

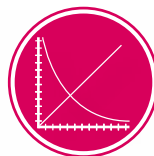

UE1050500
UE1050550
PDF online



Experiment Topics:

- Rotary oscillations
- Determination of moments of inertia using the oscillation method
- Moments of inertia of various geometric bodies
- Steiner's theorem



Torsion Axle

Robust axle for investigating rotational oscillation of various test bodies and for determining their moments of inertia from the period of oscillation. With ball-bearing mounted shaft, high-quality coil spring and holding lug. Tests are undertaken on weights, which can be moved along a thin transverse rod. A circular disc, which can be used for determining moments of inertia for eccentric axes of rotation and confirming Steiner's theorem is included.

Deflecting torque of the spring: 0.028 Nm/rad.
 Height of the torsional axle: approx. 200 mm
 Transverse rod:
 Length: 620 mm
 Weight: 135 g
 Weights: 260 g each
 Disc:
 Diameter: 320 mm
 Weight: 495 g
 Boreholes: 8
 Borehole spacing: 20 mm

U20050

Additionally required:
U13271 Stand Base Tripod, 185 mm

Additionally recommended:
U11902 Digital Stopwatch
U20032 Precision Dynamometer 1 N
U20051 Set of Test Bodies for Torsion Axle

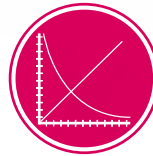

UE1040205
PDF online

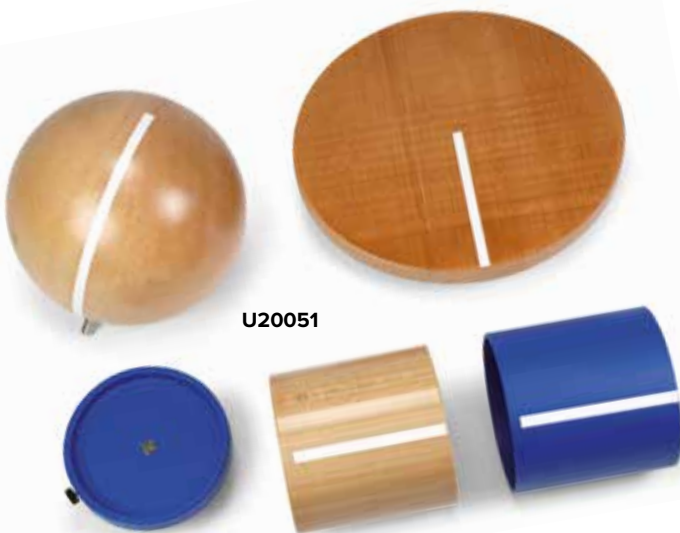

U20051

Set of Test Bodies for Torsion Axle

Accessories for the torsion axle (U20050) used to demonstrate how moment of inertia depends on the distribution of weight around the axis of rotation. Consisting of two cylinders with nearly identical weights but different weight distributions, a mounting plate for the cylinders, a wooden disc and a wooden sphere.

U20051

Hollow cylinder (metal):

External diameter: 90 mm
 Height: 90 mm
 Weight: approx. 425 g

Solid cylinder (wood):

Diameter: 90 mm
 Height: 90 mm
 Weight: approx. 425 g

Mounting plate:

Diameter: 100 mm
 Weight: approx. 122 g

Wooden disc:

Diameter: 220 mm
 Height: 15 mm
 Weight: approx. 425 g
 Moment of inertia: 0.51 kgm²

Wooden sphere:

Diameter: 146 mm
 Weight: approx. 1190 g
 Moment of inertia: 0.51 kgm²

Device for Archimedes' Principle

For demonstrating Archimedes' principle of buoyancy in liquids. Consists of a hollow cylinder with a stirrup and hook, as well as a precisely fitted solid cylinder with an eyelet.

Diameter: 55 mm
Height: 53 mm

U40875



For demonstrating Archimedes' principle for buoyancy in liquids



Metal Bridge

Accessory for hydrostatic experiments with beam balance (U17205).

U17206



Set of 5 density bodies

Set comprising five rectangular prisms made of various materials and a transparent block with a hollow body, all with the same dimensions for demonstrating Archimedes' principle. The bodies have 2-mm bores by which they can be suspended.

Materials: Wood, aluminium, iron, brass, copper
Dimensions of each body: 10x20x45 mm³

U8404556

Additionally required:
U20032 Precision Dynamometer 1N

Cartesian Diver

For demonstrating a body floating, sinking or rising in water. A hollow figure made of coloured glass, with a narrow opening. The figure floats upright in a cylinder filled with water and can be made to float, sink or rise by applying pressure to the rubber cap. The rubber cap fits cylinder diameters of approx. 30 mm to 40 mm, e.g. free-standing cylinder (U14206).

Contents:
1 Cartesian diver
1 Rubber cap

U14090

Additionally required:
U14206 Free-Standing Cylinder, without Graduation



Buoyancy

Archimedes' Beaker

Beaker with stirrup and hook including snug-fitting cylinder with eyelet for the verification of Archimedes' principle.

Diameter: 30 mm
Height: 78 mm

U40875

Additionally recommended:

U17205 Beam Balance
U17206 Metal Bridge

Buoyancy Apparatus

Apparatus for demonstrating buoyancy of fluids, consisting of a flat ground glass tube and a plastic disc with rubber covering to form a base plate to which a long string is attached. The base plate makes a watertight connection with the glass tube and when both are immersed in water, the plate does not sink because buoyancy keeps it pushed up against the tube.

Glass tube: 200 mm x 28 mm diam.
Metal disc: 2 mm x 42 mm diam.
Length of string: 35 cm

U8410355



Mechanics

Set of 3 Cylinders, Equal in Volume

Set of three cylinders of equal volume and unequal mass each with a hook.

Materials: Aluminium, iron, brass
 Dimensions of cylinders: 40 mm x 20 mm diam. approx.

U8403315

Additionally recommended:
U42050-230 Electronic Scales 600 g (230 V, 50/60 Hz)
U14205 Graduated Cylinder, 100 ml



Density Paradox Set

Two identical plastic cylinders with a density close to that of water. If the first is immersed in hot water, it will initially sink but will then float up to the surface after a short time. If the second one is then put into ice-cold water, it will initially float but will then sink to the bottom. The reason for this is that the density of the plastic changes more than that of the water when it is heated or cooled.

U45056

Additionally recommended:
2 Beakers from U14210

Set of 3 Cylinders, Equal in Mass

Set of three cylinders of equal mass and unequal volume each with a hook.

Materials: Aluminium, iron, brass
 Mass of cylinders: 100 g

U8403325

Additionally recommended:
U42050-230 Electronic Scales 600 g (230 V, 50/60 Hz)
U14205 Graduated Cylinder, 100 ml

Immersion Blocks

Immersible body of known volume with hook. Can be used in conjunction with scales to determine the density of solid bodies and with a dynamometer for determining buoyancy.

Art. No.	Description
U15036	Al, 50 cm ³
U15037	Al, 100 cm ³
U15038	Fe, 50 cm ³
U15039	Fe, 100 cm ³

Additionally recommended:
U42050-230 Electronic Scales 600 g (230 V, 50/60 Hz)
 or
U20035 Precision Dynamometer 10 N

Set of 3 Areometers

Set of areometers for determining the density of liquids in g/ml at a reference temperature of 20°C / 68°F. Without thermometer, in storage container.

U16106

Measuring range	Scale division	Length
0.650 – 1.000 g/ml	0.005 g/ml	315 mm
1.000 – 1.500 g/ml	0.005 g/ml	235 mm
1.500 – 2.000 g/ml	0.005 g/ml	235 mm

Alcohol Meter

Gay-Lussac alcohol meter for determining the alcohol content in percentage by volume of ethanol/water mixtures at a reference temperature of 15°C. Without thermometer, in storage container.

Scale: 0 to 100% vol
 Division: 1%
 Length: 260 mm

U14290

Universal Areometer

Areometer for determining the density of liquids in g/ml at a reference temperature of 20°C. Without thermometer, in storage container.

Measuring range: 0.7 – 2 g/ml
 Scale division: 0.02 g/ml
 Length: 310 mm

U14291

Gay-Lussac Pycnometer

Glass body with ground capillary stopper for determining the density of liquids.

Volume: 50 ml

U14220



Pressure Container for Determining Weight of Air

Airtight metal can with valve for demonstrating weight of compressed air. With bicycle valve for pumping in air. The weight of the air pumped in is determined by weighing and the volume can be determined by gauging the capacity.

Dimensions: 60x190 mm² approx.

Weight: 100 g approx.

U8412150

Additionally required:

U42049-230 Electronic Scales 400 g (230 V, 50/60 Hz)

Bicycle Pump



U8412150

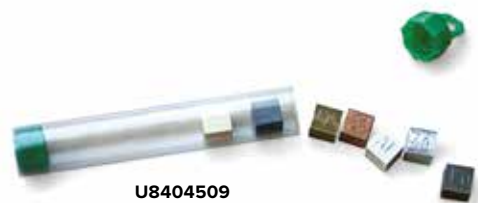

U8404509



U8422050

Set of 2 Materials with 4 Different Masses Each

Two sets of test bodies made of the same material but with four different masses for deriving the concept of density in school experiments. Supplied in storage containers.

Materials: Aluminium, PVC

U45057

Additionally recommended:

U42050-230 Electronic Scales 600 g (230 V, 50/60 Hz)

U14205 Graduated Cylinder, 100 ml

U45057

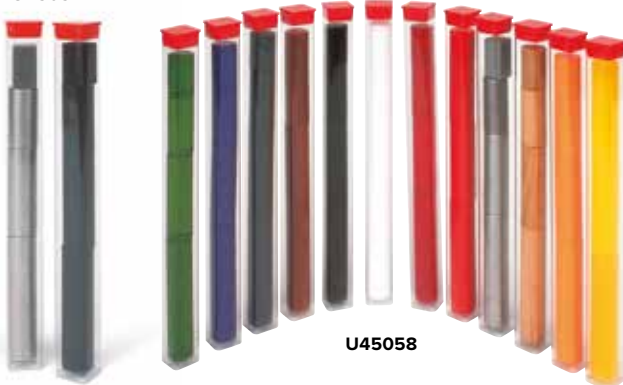

U45058

Set of 12 Materials with 4 Different Masses Each

Twelve sets of test bodies made of the same material but with four different masses for deriving the concept of density in school experiments. Supplied in storage containers.

Materials: Wood, polypropylene, polyamide, acrylic (2 colours), polyurethane, phenol, PVC (3 colours), Teflon and aluminium

Densities: 0.71 – 2.71 g/m²

Dimensions: 25 / 35 / 50 / 70 mm x 16 mm diam. approx.

U45058

Additionally recommended:

U42050-230 Electronic Scales 600 g (230 V, 50/60 Hz)

U14205 Graduated Cylinder, 100 ml

Set of 7 Cubes for Determining Density

Set of seven cubes made of various materials for determining densities by weighing. Supplied in a storage case.

Materials: Wood, plastic, aluminium, iron, copper, brass, zinc

Side of cubes: 10 mm

U8404509

Additionally required:

U42050-230 Electronic Scales 600 g (230 V, 50/60 Hz)

Sphere for Weighing Gases 1000 ml

Glass sphere with two taps and nozzles for attaching tubing for demonstrating the weight of air from the difference in weight between the sphere when filled with air and when evacuated.

Weight: 200 g approx.

U8422050

Additionally recommended:

U42049-230 Electronic Scales 400 g (230 V, 50/60 Hz)

U205001 Vacuum Hand Pump

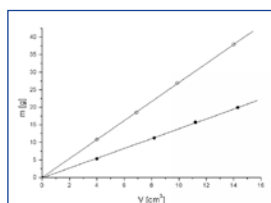

Determining the density of aluminium and PVC

U45059

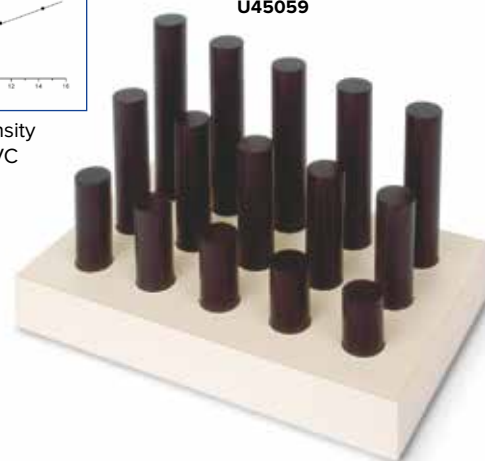

Set of 15 Bodies with 2 Different Densities

Set of 15 test bodies of various masses made of two identical looking materials for deriving the concept of density in experiments at school. Supplied on a storage tray.

Materials: Plastic of density 1.41 g/cm³ and 1.15 g/cm³

U45059

Additionally recommended:

U42050-230 Electronic Scales 600 g (230 V, 50/60 Hz)

U14205 Graduated Cylinder, 100 ml



U15070

Pascal's Vane Apparatus

For demonstrating the hydrostatic paradox and for quantitative measurements of ground pressure. This pressure is measured through the curvature of a membrane and indicated in magnified form with the help of a lever multiplier. Compensation for comparative measurements is possible. Includes four differently shaped vessels made of glass.

- Height of the vessels: 220 mm
- Tube diameter at the bottom: 22 mm
- Total height: 350 mm
- Base-plate area: 260x110 mm²
- Weight: 0.8 kg

U15070

Hydraulic/Pneumatic Lifting Platform

Complete equipment set for demonstration and practical training such as investigating transmission of hydraulic or pneumatic force, the relationship between force, surface area and pressure as well as verification of Boyle's law. A rugged stand holds a cylinder with piston (60 cm³ volume). The lifting platform is positioned on the piston. Various levels of pressure can be exerted on the piston using a system of tubing with 3 simple hand pumps of different volumes. A hose fitting for connection of a pressure sensor required to record measured values with a datalogger is also included.

- Dimensions: approx. 140 mm diam. x 190 mm
- Pump volumes: 3 cm³, 6 cm³, 20 cm³

U45053

Pressure Balance

Introducing the concept of pressure, for comparing pressures, for gas-compression experiments and for demonstrating overpressure and underpressure. Two precision glass syringes of different volumes with ground piston and weight pans on stand. Includes 15 disc weights on a storage rod for adding to plunger. Connection between the syringe hoses via a tubing clamp, safety catch for the smaller piston.

- Volume of syringes: 10 ml and 50 ml
- Ratio of piston cross-sections: 10:3
- Ratio of piston masses with weight pans: 10:3
- Mass of weights: approx. 400 mN each
- Baseplate dimensions: approx. 140x100 mm²

U10355



U10355

Hydraulic/Pneumatic Lifting Platform

Complete equipment set for demonstration and practical training such as investigating transmission of hydraulic or pneumatic force, the relationship between force, surface area and pressure as well as verification of Boyle's law. A rugged stand holds a cylinder with piston (60 cm³ volume). The lifting platform is positioned on the piston. Various levels of pressure can be exerted on the piston using a system of tubing with 3 simple hand pumps of different volumes. A hose fitting for connection of a pressure sensor required to record measured values with a datalogger is also included.

- Dimensions: approx. 140 mm diam. x 190 mm
- Pump volumes: 3 cm³, 6 cm³, 20 cm³

U45053



U45053

Pascal's Pressure Sphere

Glass vessel with movable plungers for demonstrating equal distribution of pressure in all directions, observed by means of water jets forced out under pressure.

- Total length: 350 mm
- Diameter: approx. 70 mm

U14325



U14325

U-Shaped Manometer D

Demonstration manometer for measuring pressure in centimetres of water. The manometer consists of a U-tube open at both ends attached to a fibre-board (MDF) featuring a scale.

- Length of each leg: 50 cm
- Measuring range: 0 – 50 cm of water or 0 to 5 kPa
- Tubing diameter: 10 mm
- Dimensions: 200x150x530 mm³ approx.
- Weight: 820 g approx.

U30082

Additionally recommended:
U8410620 Indigo Solution

U30082

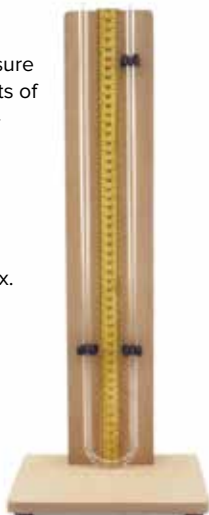

U-tube Manometer S

Manometer for measuring pressures in the range 0 to 10 hPa (cm water column). U-tube open on both sides with overflow basin on aluminium base plate with scale. Includes stand rod on the reverse for attaching to stand base.

- Length of arms: 200 mm
- Stand rod: 33 mm x 10 mm diam.
- Base plate: 210x70 mm² approx.
- Weight: 80 g approx.

U8410450

Additionally required:
U8410620 Indigo Solution

Additionally recommended:
U10146 Silicon Tube, 1 m

U8410450



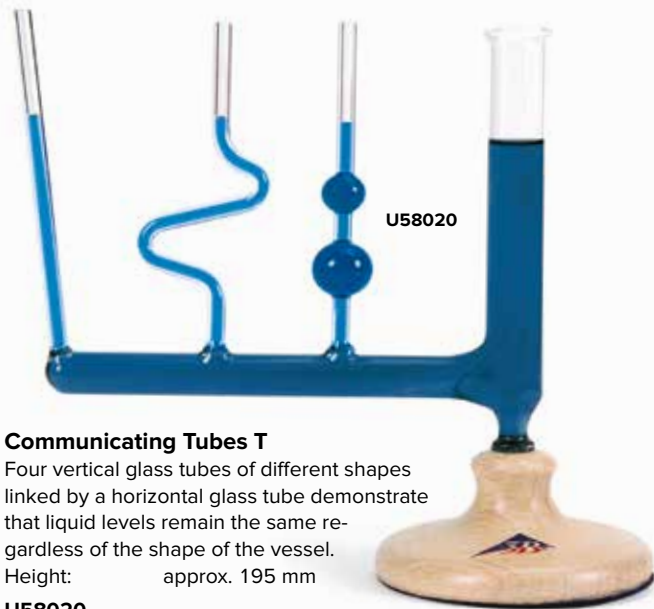

Communicating Tubes T

Four vertical glass tubes of different shapes linked by a horizontal glass tube demonstrate that liquid levels remain the same regardless of the shape of the vessel.
Height: approx. 195 mm

U58020

Surface Tension Ring

Aluminium ring with a blade for determining the surface tension of liquids. Includes a hook and three threads for suspension from a dynamometer.

Diameter: 60 mm
Weight: 5 g approx.

U8412160

Additionally required:
U15020 Laboratory Jack
U20030 Dynamometer 0.1 N
U14210 Beaker, 600 ml
Stand equipment

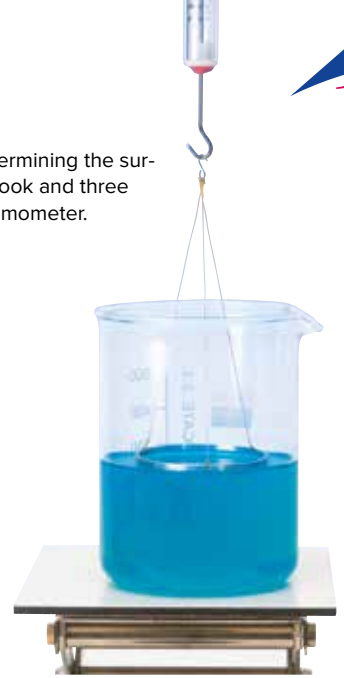

U8412160



Glass Cylinder with 2 Tubes

Glass vessel for demonstrating communicating tubes. Consists of a glass cylinder with two openings and GL screw connections, as well as two differently shaped glass tubes.
Height: approx. 220 mm

U14321



U58021

Apparatus for Investigation of Capillary Effects

A horizontal glass tube can be connected to a water reservoir through capillary tubes of different diameters. The smaller the diameter of the capillary tube, the higher the water climbs above the level of the reservoir due to the greater hydrostatic pressure.
Internal diameters of the capillary tubes: 2.0 mm, 1.5 mm, 1.0 mm and 0.5 mm
Height: 165 mm approx.

U58021

Outlet Vessel, Metal

Robust metal cylinder with three outlets at various heights for the purpose of investigating hydrostatic pressure due to depth of water by observing the jets of water emerging from the outlets under pressure.
Height: 430 mm approx.
Diameter: 125 mm approx.

U30084



U30084

Indigo Solution (not shown)

30 ml indigo solution in a flask, for colouring water in demonstration experiments.

U8410620



U8411130

Wedge Shaped Vessel

Wedge shaped vessel made of transparent acrylic for demonstrating the surface tension of liquids and capillary forces.
Length: 100 mm

U8411130

Viscosity measurements using the following substances

- Light oils, machine oils, petroleum, petroleum ether, diesel (mineral oils and fuels)
- Plastic solutions, resin solutions, adhesive solutions, latex dispersions (polymer chemicals)
- Printers' ink, varnish, water-based paints, inks (inks and paints)
- Emulsions, suspensions, solutions, extracts (cosmetics/pharmaceuticals)
- Emulsions, dispersions (paper industry)
- Liquid detergents, washing-up liquid, surfactant solutions (detergents)
- Honey, fruit juice, beer, milk (food industry)
- Gases and mixtures of gases

Falling Sphere Viscometer

Höppler-type falling sphere viscometer for simple but accurate measurement of dynamic viscosity of transparent Newtonian fluids. The sphere rolls and slides inside an inclined cylindrical tube filled with the fluid to be tested. The viscosity is measured in $\text{mPa} \cdot \text{s}$ and is derived directly from the time the sphere takes to fall a specified distance through the fluid in the measuring tube. The tube can then be turned upside-down so that time the sphere takes to fall back can also be measured. The tube is situated inside a water bath, which can be filled with water at a specific temperature in order to measure how viscosity depends on temperature.

Includes:

Falling sphere viscometer with 6 spheres and 1 ball gauge
 Thermometer 0 – 100° C
 Cleaning set
 Test certificate with accurate values for sphere constant K and density ρ for converting duration of fall to actual viscosity.

Technical data

Measuring range:	0.5 $\text{mPa} \cdot \text{s}$ to $7 \cdot 10^4 \text{ mPa} \cdot \text{s}$ (as per DIN 53015) > $7 \cdot 10^4 \text{ mPa} \cdot \text{s}$ (for sphere fall times > 300 s)
Measurement precision	0.5 to 2% (depending on spheres used)
Spheres:	#1, #2: Borosilicate glass #3, #4: Ni-iron #5, #6: Steel
Diameter of spheres:	11.00 to 15.81 mm
Diameter of measuring tube:	15.95 mm
Fall times for spheres	30 to 450 s
Length of measured distance:	100 mm in both directions
Operating angle:	10° to vertical
Additional working angles	70°, 60°, 50° to horizontal
Volume when full:	40 ml
Permissible temperature range:	-60°C to +150°C
Dimensions:	180x220x330 mm
Weight:	3.1 kg

U14260

Additionally required:

U11902 Digital Stopwatch

Additionally recommended:

U10146 Silicone Tubing (2x)

U144002-230 Immersion/Circulation Thermostat (230 V, 50/60 Hz)

or

U144002-115 Immersion/Circulation Thermostat (115 V, 50/60 Hz)

Glycerine

250 ml of glycerine in aqueous solution for experiments on viscosity. In glass bottle
 Concentration: 85%

U8496816



U8496816

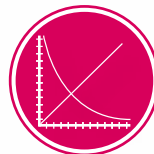

UE1080350
PDF online



U144002-230
U144002-115



U14260

new

Experiment Topics:

- Elastic deformation of flat bars
- Determining modulus of elasticity

Advantages

- Load characteristics of the strain gauge may be ignored
- Measurements can be set up with the material samples supported on both sides or clamped at one end

Apparatus for Measuring Young's Modulus

Measuring apparatus for investigating the elastic deformation of rods of flat geometry and for determining the modulus of elasticity. Features a strain gauge unit for determining the deformation of electrically conducting material samples. The strain gauge unit is electrically connected to the material sample in such a way that placing of the probes on the sample is determined with a high degree of sensitivity and displayed with the help of two LEDs. The bending of the material sample with the weight suspended is measured to an accuracy of 0.01 mm and the modulus of elasticity can then be calculated from the reading.

Battery for strain gauge unit: 9 V, 6F22
 Dimensions: 550x280x500 mm³
 Weight: 5.5 kg approx.

Contents:

- 6 Flat steel rods (w: 15 mm, l: 200 / 300 / 400 mm, thickness: 2 / 3 mm)
- 1 Strain gauge unit
- 1 Horizontal beam with stand
- 2 Knife-edge bearings
- 1 Clamping chuck
- 1 Set of weights and retaining clamps

U8557260

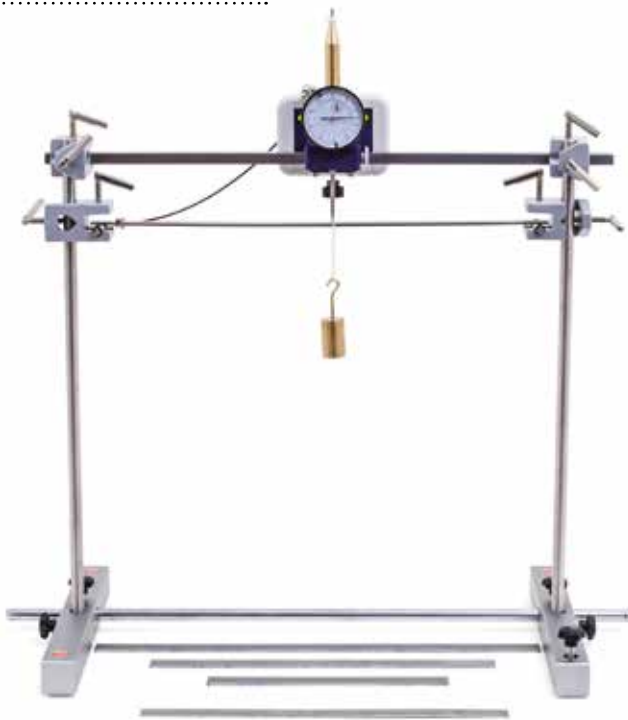

U8557260

Young's Modulus Supplementary Set (not shown)

Set of flat bars with the effective lengths of 200, 300 and 400 mm and the widths of 10 and 20 mm for measurement of elastic deformation and modulus of elasticity using the modulus of elasticity equipment set (U8557260).

Contents:

- 12 Flat bars made of steel (thickness: 2 / 3 mm)
- 6 Flat bars made of aluminium (thickness: 3 mm)

U8757270

new

Experiment Topics:

- Torsion on cylindrical bars
- Determining the shear modulus

Advantages

- Simple set-up and operation
- Static and dynamic measurements possible without time-consuming reconfiguration

Torsion Apparatus

Measurement apparatus for investigating torsion as applied to bars with cylindrical geometry and to determine both directivity values and shear modulus. With a scaled disc for torsion angle measurement and a pendulum disc for transmission of torsional forces to the clamped material samples in the case of static measurements as well as for the determining moment of inertia in the case of dynamic measurements. The period of oscillation is measured electronically in the dynamic case using a light barrier. The approximate variables and the shearing modulus are derived from the measurements.

Dimensions: 570x300x300 mm
 Weight: 2.3 kg approx.

Contents:

- 1 Cylindrical bar made of steel (d: 2 mm, l: 500 mm)
- 1 Basic unit of torsion apparatus
- 1 Base plate for light barrier (U11365)

U8557300

Additionally required:

U40810 Dynamometer, Colour-Coded, 2.5 N

U40811 Dynamometer, Colour-Coded, 5 N

U11365 Light Barrier

U8533341-230 Digital Counter (230 V, 50/60 Hz)

or

U8533341-115 Digital Counter (115 V, 50/60 Hz)

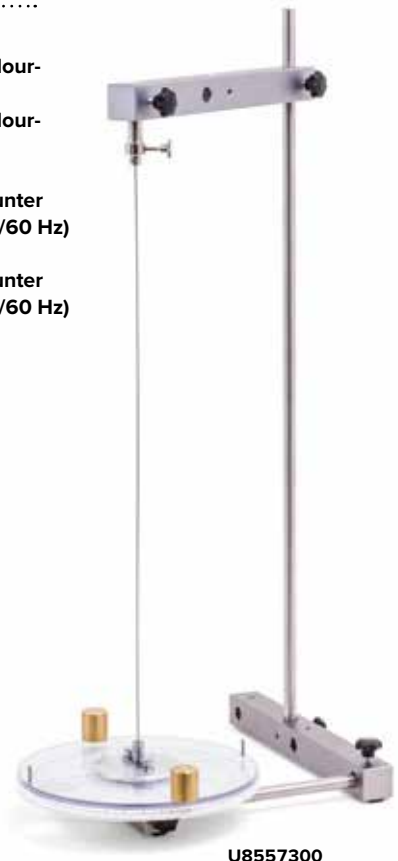

U8557300

Supplementary Set for Torsion Apparatus (not shown)

Set of round bars for measuring torsion, directivity and shearing modulus with the torsion apparatus (U8557300).

Contents:

- 1 Cylindrical bar made of steel (d: 2 mm, l: 300 mm)
- 6 Cylindrical bars made of brass / copper / aluminium / (d: 2 mm, l: 300 / 500 mm)
- 2 Cylindrical bars made of aluminium (d: 3 / 4 mm, l: 500 mm)

U8557430



U29497

Vacuum Chamber with Hand Pump

Inexpensive, transparent plastic vacuum chamber for basic experiments with low pressure. Hand pump integrated into base plate, bleed valve and manometer for measuring pressure down to 330 hPa.

Dimensions: Ø 200 mm, H = 250 mm approx.

U29497

Additionally required:
U29496 Set of 100 Balloons



U30010

U205001

Magdeburg Hemispheres

To demonstrate Von Guericke's historical experiment on the effect of atmospheric air pressure. Two plastic hemispheres equipped with handles can be joined vacuum-tight using the insertable rubber sealing ring. One hemisphere is equipped with a stopcock and hose connection. Including air hose.

Vacuum connection: 8 mm
 Diameter: 120 mm
 Hose length: 110 mm

U30010

Additionally required:
U205001 Vacuum Hand Pump



U45054

Magdeburg Plates

Equipment set for demonstrations and practical teaching of Guericke's historical experiment investigating the effect of atmospheric pressure. Includes nozzle for tubing, a simple hand pump and tubing with built-in directional valves. Two transparent acrylic plates with handles that can be held together with a coarse vacuum between them. Three sealing rings of various sizes are supplied for sealing the plates. This allows the dependency of the force on the contact area to be investigated.

Acrylic plates: approx. 13x105 mm diam.
 Sealing rings: approx. 65 mm, 80 mm, 100 mm diam.

U45054



U29496

Set of 100 balloons

Set of 100 balloons for use in vacuum chamber with hand pump.

U29496

Vacuum Bell Jar

Vacuum bell jar made of glass with grip knob and polished flange to be set on top of the vacuum experiment plate (U21850).

Inner diameter: 190 mm
Total height: 220 mm

U21851



Vacuum Experiment Plate

Experiment plate for the assembly of a vacuum chamber in conjunction with the vacuum bell jar (U21851) for experiments in the coarse and fine vacuum range. Metal plate with sealing ring on a tripod, hose connection of the pump-side and ventilation cock. Includes two-pole current feed via 4-mm safety sockets and cable of approximately 1 m length with 4 mm safety plugs, plus a central bore with M12 thread for attaching experimental equipment.

Diameter: 250 mm
Height: 90 mm
Electrical limit specs.: max. 48 V, max. 12 A
Vacuum connection: 2 hose nozzles 12 mm and 8 mm diam.

U21850

Additionally required:
U21851 Vacuum Bell Jar
U34000 Rotary-Vane Vacuum Pump, Two-Stage
U10140 Vacuum Hose 8 mm

Vacuum Recipient

Inexpensive vacuum recipient made of transparent acrylic for experiments in coarse and fine vacuums. Comprises a base and vacuum cylinder with venting valve, manometer, inlet tap, entrance for contacts and rubber ring.

Volume: 9 l approx.
Leakage rate: < 0.5 mbars/h
Base plate: 320x320x10 mm approx.
Vacuum cylinder: 200x240 mm (diam.) approx.
Thickness of walls: 5 mm
Weight: 2.9 kg approx.

U8421300

Additionally required:
U10148 Vacuum Tubing, 4 mm
U34000 Rotary-Vane Vacuum Pump, Two-Stage

U8421300



Electric Doorbell

Bell for demonstrating electro-magnetic operation of apparatus and verifying that sound waves do not propagate in a fine vacuum (< 1 hPa). Open acrylic housing with 4-mm safety sockets.

Power supply: 6 V AC
Dimensions: 100x95x50 mm³

U21854

Additionally required:
Vacuum Chamber
Vacuum Pump
U33300-230 Transformer with Rectifier 3/ 6/ 9/ 12 V, 3 A (230 V, 50/60 Hz)
or
U33300-115 Transformer with Rectifier 3/ 6/ 9/ 12 V, 3 A (115 V, 50/60 Hz)

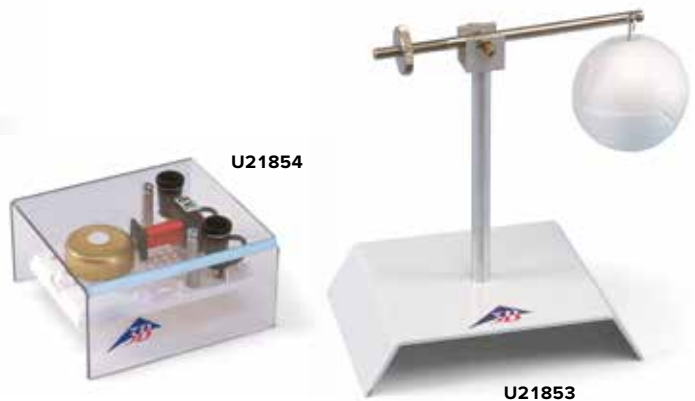

Baroscope

Beam balance on base with suspended polystyrene ball and adjustable counterweight for demonstrating buoyancy on a body due to atmospheric pressure. At a state of equilibrium a Baroscope is placed in a vacuum bell jar under atmospheric pressure. The air in the bell jar is then evacuated, the Styrofoam sphere falls on account of the reduction in lift.

Styrofoam sphere: 50 mm diam.
Base: 120x90 mm²
Height: 125 mm

U21853

Additionally required:
Vacuum Chamber
Vacuum Pump



U10141

U10140



U10147

U10148

Vacuum Hoses

Vacuum hoses made of natural rubber according to DIN 12865. Colour red.

	U10148	U10147	U10140	U10141
Length	1 m	1 m	1 m	1 m
Internal diameter	4 mm	6 mm	8 mm	10 mm
Wall strength	4 mm	4 mm	5 mm	5 mm
Temperature range	-30° up to + 85°	-30° up to + 85°	-30° up to + 85°	-30° up to + 85°

Water-Jet Pump

Pump for experiments in a coarse vacuum; equipped with an integrated non-return valve to prevent water rise; can be disassembled.

Material: Plastic
 Suction capacity: approx. 4 l/min (dependent on water pressure)
 Final total pressure: approx. 15 hPa (dependent on water temperature)

Pump-out time for a 5 l container: 6 to 10 minutes
 Threaded joint: R 1/2" with inserts for R 3/8" and R 3/4"

U16050



U16050



U8421210

Piston Vacuum Pump

Robust two-stroke piston pump for vacuum experiments, for final vacuum pressures down to 400 hPa. Air is pumped out on both the upward and the downward stroke of the piston. Includes carrying rod with handles and heavy base plus vacuum hose diam. 5 mm.

Final pressure: 400 hPa
 Tubing nozzle: 5 mm diam.
 Dimensions: approx. 160x235x560 mm³

Weight: approx. 1.7 kg

U8421210

Vacuum Hand Pump

Simple mechanical air pump for filling and evacuating small containers; equipped with an ergonomic handle, a manometer with a pointer that rotates through a full 360°, a ventilation valve, two hoses (long and short) and six connecting adaptors.

Manometer: -980 hPa – 4000 hPa
 Tubing nozzle: 8.5 mm diam.
 Hose: 850 mm x 6.5 mm internal diam.
 65 mm x 4.5 mm internal diam.
 Dimensions: approx. 180x60x260 mm³
 Weight: approx. 0.3 kg

U205001



U205001

Rotary-Vane Vacuum Pump, One-Stage

High performance, compact, one-stage, oil-sealed rotary vane pump for vacuum experiments. With thermal overload protection, handle, air valve, manometer and hose nipple. Includes pump oil.

Suction capacity: 100 l/min
 Final pressure: 0.05 hPa
 Motor power: 245 W
 Manometer: 0 – 1000 hPa
 Hose nipple: 10 mm diam.
 Supply voltage: 115 V or 230 V, 50/60 Hz
 Dimensions: approx. 335x138x250 mm³
 Weight: approx. 8 kg

U34010

Rotary-Vane Vacuum Pump, Two-Stage

High performance, compact, two-stage, oil-sealed rotary vane pump for vacuum experiments. With thermal overload protection, handle, air valve, manometer and hose nipple. Includes pump oil.

Suction capacity: 100 l/min
 Final pressure: 0.003 hPa
 Motor power: 245 W
 Manometer: 0 – 1000 hPa
 Hose nipple: 10 mm diam.
 Supply voltage: 115 V or 230 V, 50/60 Hz
 Dimensions: approx. 335x138x250 mm³
 Weight: approx. 11 kg

U34000



U34010



U34000

Metering Valve, DN 16 KF

Adjustable using micrometer screw.

Connection: DN 16 KF

U13115



2-Way Ball Valve DN 16 KF

Connection: DN 16 KF
Length: 100 mm

U14510

Crosspiece DN 16 KF

Connection: DN 16 KF
Dimensions: 80x44 mm²

U14511

T-Piece DN 16 KF

Connection: DN 16 KF
Dimensions: 50x44 mm²

U14512

Adaptor Flange

DN 16 KF / Shaft 12 mm

Adaptor flange for connecting a vacuum hose to ISO-KF systems.

Connection: DN 16 KF

Tubing nozzle: 12 mm

Length: 40 mm

U14515

Adaptor Flange

DN 16 KF / NS 19/26

Adaptor flange for connecting components with internally ground nozzles, e.g. gas discharge tube (U14380, to ISO-KF systems.

Connection: DN 16 KF

Core: 19/26 NS

Length: 40 mm

U14516

Ventilation Valve DN 16 KF

Connection: DN 16 KF

Dimensions: 36 mm x 26 mm diam.

U14513

Dummy Flange DN 16 KF

Connection: DN 16 KF

U14514

Rotary-Vane Vacuum Pump, P 4 Z

Compact, two-stage rotary pump with high suction capacity. Automatic lubrication of the rotary valve and ball bearings using optimized oil pressure increases the final pressure levels achievable, stabilizes the pump temperature and prolongs the pump's working life. Includes direct drive with elastic coupling. Device exhibits good resistance to chemicals and a high degree of water vapour compatibility. A suitable mechanism prevents the oil from rising back to contaminate the recipient. Lightweight device that operates with low noise. High-quality parts make the device capable of continuous operation. The pump is complete and ready for connection with a full complement of oil, centring ring, locking ring, motor protection circuit breaker, mains switch and connection cable with mains plug.

Connecting flange: DN 16 KF

Suction performance (Pneurop): 77/92 l/min at 50/60 Hz

Final pressure (without partial gas ballast): 2×10^{-4} hPa

Final pressure (with total gas ballast): 1×10^{-2} hPa

Water vapour tolerance: 40 hPa

Motor output: 200 W

Oil capacity: 530 ml

Supply voltage: 100 / 115 / 230 V, 50/60 Hz

Dimensions: 415x150x235 mm³ approx.

Weight: 17.5 kg approx.

U14501-230

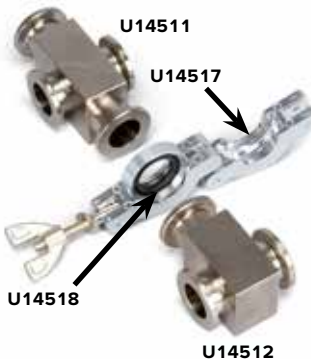

Tension Ring DN 10/16 KF

Tension ring for mechanically secure connection of ISO-KF components.

Connection: DN 16 KF

U14517

KF External Centring Ring DN 10/16 KF

Rubber sealing ring for ISO-KF connections.

U14518

Pirani Vacuum Gauge

An easily programmable desktop device for measurement and control in fine and coarse vacuums using a Pirani vacuum gauge. Includes a clearly arranged membrane keypad, measuring line (2.5 m) and mains cable.

Vacuum connection: DN 16 KF

Measuring range: 1100 – 0.001 hPa

Measurement uncertainty: < 20% of the display value

Display: Digital LED display in mbar, Pa, psi, torr

Digit height: 10 mm

Readout: 5 per s

Threshold switch: 2x 230 V, 2 A, independently adjustable

Switching accuracy/hysteresis: ± 1 digit

Permissible overload: 2 bar absolute

Power consumption: max. 15 W

Supply voltage: 100 / 115 / 230 V, 50/60 Hz

Dimensions: 90x120x90 mm³ approx.

Weight: 0.9 kg approx.

U145051-230



U14501-230



U145051-230

Jet Nozzle (Flow Laminator)

Nozzle for emitting a near laminar air stream, e.g. for experiments with the set of drag and lift objects or experiments on recoil. Mounted on a stem. The very light air nozzle contains no moving parts and generates no spin. It spreads out the air stream from a connected fan. Air that comes out of the tubular nozzles near the plastic ring mixes with the secondary air to form an overall air stream of a large diameter. Includes a hose.

- Air inlet: 33 mm
- Air outlet: 120 mm
- Dimensions: 255x150 mm²
- Stand holder: 10 mm
- Weight: approx. 350 g

U8404250

Additionally required:

U15425-230 Air Flow Generator
(230 V, 50/60 Hz)

or

U15425-115 Air Flow Generator
(115 V, 50/60 Hz)

Stand Equipment



U8404250

Component Balance

Scales for measuring components with holding mechanism for measuring air resistance and buoyancy of bodies from set U8404260. On rod.

- Measuring range: 0 – 0.3 N
- Diameter of the scale: 170 mm
- Dimensions: approx. 350x220 mm²
- Rod diameter: 10 mm
- Weight: approx. 0.9 kg

U8404261



U8404261



U8404260

Air Flow Generator

Fan allowing continuous adjustment of air flow. Includes a hose.

- Hose length: approx. 1.5 m
- Power consumption: max. 1100 W
- Dimensions: 300x180x170 mm³
- Weight: 4.4 kg

Air Flow Generator (230 V, 50/60 Hz)

U15425-230

Air Flow Generator (115 V, 50/60 Hz)

U15425-115



U15425-230
U15425-115

Set of bodies for air resistance and buoyancy experiments

Set of 7 wooden models on stems for measuring buoyancy and fluid resistance of various bodies in laminar air flows. Including storage block.

Contents:

- 1 streamlined body, smooth, l = 120 mm
- 1 streamlined body, rough, l = 120 mm
- 1 ball, d = 50 mm
- 1 circular disc, d = 47 mm
- 1 circular disc, d = 68 mm
- 1 hemisphere, d = 50 mm
- 1 plate, 150 mmx40 mm
- 1 wing profile, l = 150 mm

U8404260

Additionally required:

U8404250 Jet Nozzle (Flow Laminator)

U8404261 Component balance

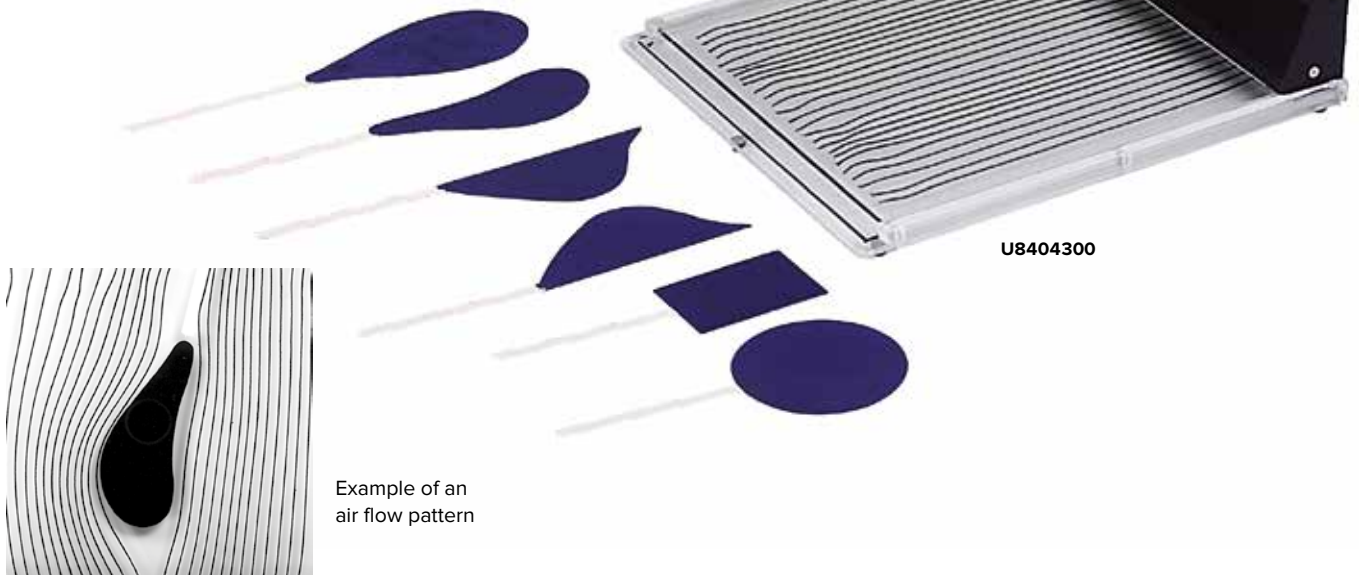

Example of an air flow pattern

Air Flow Apparatus

Apparatus for demonstrating air flow patterns around bodies of different shapes. The air flow patterns can be projected on to a wide screen using an overhead projector. Two strings are fastened on one side at equal distances between two glass plates. The strings move according to the air currents between the two glass plates. Bodies of different shapes can be introduced in the air current. The inserted bodies can be moved to various positions in the air current from outside. Includes a hose.

Dimensions: approx. 385x310x75 mm³
 Weight: approx. 3.2 kg

Contents:

- 1 Air flow apparatus
- 1 Circular body
- 1 Rectangular body
- 1 Streamlined body
- 1 Wing section
- 2 Bodies to demonstrate narrowing of flow
- 1 Hose

U8404300

Additionally required:

- U15425-230 Air Flow Generator (230 V, 50/60 Hz)** or
- U15425-115 Air Flow Generator (115 V, 50/60 Hz)**

Additionally recommended:

Overhead Projector



U8404248

Laminar Flow Apparatus

For demonstrating and investigating the laminar flow properties of water. The emergence of currents in water, the flow of current in the case of straight laminar flow and the overflow of differently shaped bodies can be studied. The flow of current at a narrows can also be demonstrated clearly. A rectangular piece of velour paper is placed in the apparatus consisting of an upper and lower trough. Owing to capillary forces, water from the upper trough is drawn in by the paper. The water flows down into the velour paper. The flow of water in the upper level is marked with a dye at constant intervals. Owing to the low speed of flow of approx. 2 mm/s, the development of currents can be observed with the help of the dye. After the velour paper has been dried, a lasting current pattern remains, which can be copied and evaluated.

Dimensions: approx. 220x140x240 mm³
 Weight: approx. 1 kg

U8404248

Contents:

- 2 Acrylic glass basins
- 1 Mask
- 20 Sheets of velour paper with cut-outs
- 1 Mini-flask with dye
- Swab for dye
- Rubber gloves

Experiment Topics:

- Straight-line propagation of microwaves
- Reflection, absorption and transmission
- Shielding from microwaves
- Experiments on polarisation
- Experiments on diffraction
- Experiments on refraction and interference
- Transmission of information

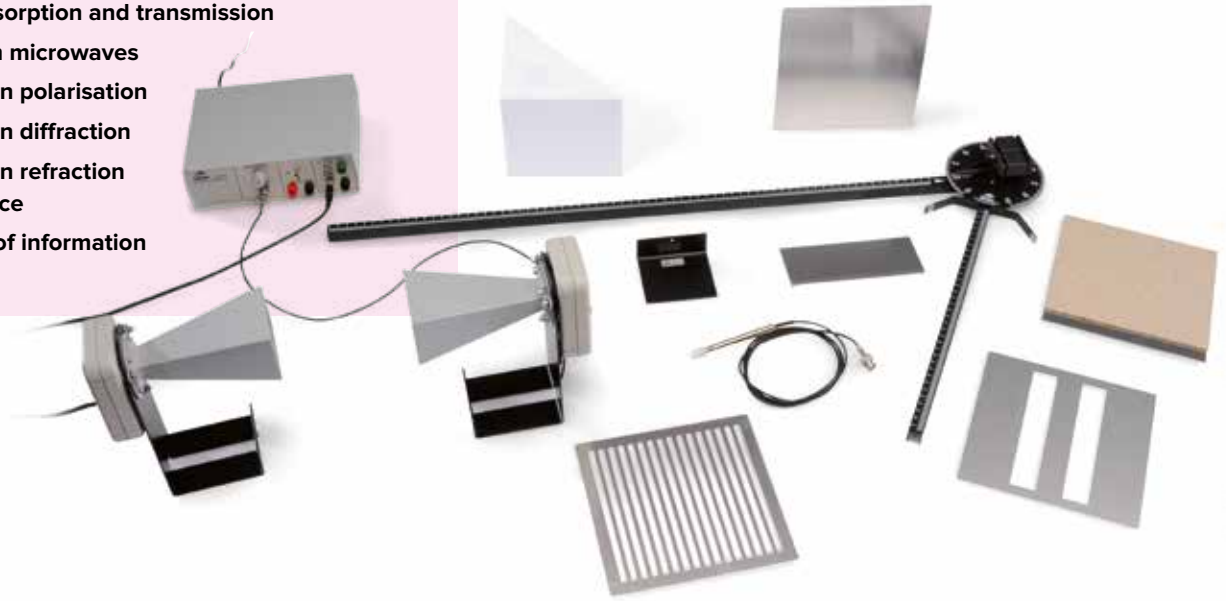

Microwave Set

Equipment set for conducting wave optics experiments involving wavelengths in the cm range. A transmitter with a horn antenna radiates a narrow beam of linearly polarised electromagnetic waves with a wavelength of about 3 cm. The direction of polarisation can be altered by rotating the antenna around the axis of propagation. To detect the waves, a horn antenna receiver and a microwave sensor are provided. A control unit converts the intensity of the signal received into a proportionally large output voltage that can be measured using a voltmeter. It is also possible to switch on an acoustic signal with a volume that is proportional to the intensity of the signal.

Oscillator frequency:	9.4 GHz (U8493600-230)
	10.5 GHz (U8493600-115)
Power of transmitter:	10 – 25 mW
Internal modulator frequency:	3 kHz approx.
Acoustic signal:	Switchable
External modulation:	100 Hz – 20 kHz, 1 V max.
Output voltage:	10 V max.
Receiver with horn antenna:	Silicon diode with resonator
Microwave sensor:	Silicon diode with resonator
Dimensions of basic apparatus:	approx. 160x200x75 mm ³

Contents:

- 1 Control unit
- 1 Plug in power supply
- 1 Transmitter with horn antenna
- 1 Receiver with horn antenna
- 1 Microwave probe
- 1 Microwave bench, 800 mm
- 1 Microwave bench, 400 mm with plate holder
- 1 Reflection plate 180x180 mm²
- 1 Polarisation grating, 180x180 mm²
- 1 Absorption plate, fibreboard, 180x180 mm²
- 1 Paraffin prism
- 1 Stand for prism
- 1 Plate with double slit
- 1 Cover plate for double slit

Microwave Set 9.4 GHz (230 V, 50/60 Hz)

U8493600-230

Microwave Set 10.5 GHz (115 V, 50/60 Hz)

U8493600-115

Additionally recommended:

U8557330 Analogue Multimeter ESCOLA 30

Note:

Our recommendations for wave optics experiments using visible light can be found in the section "Light and optics".

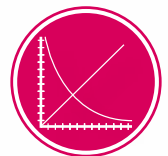

UE3060300
PDF online

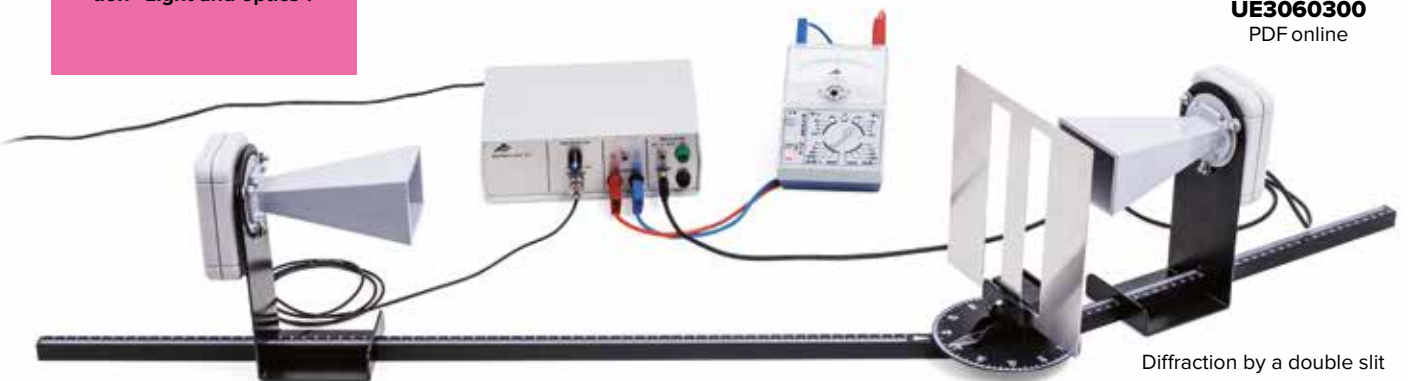

Diffraction by a double slit



U8557290

Paraffin Prism

Plastic prism filled with paraffin for use with microwave set (U8493600-115 or U8493600-230).

U8557290

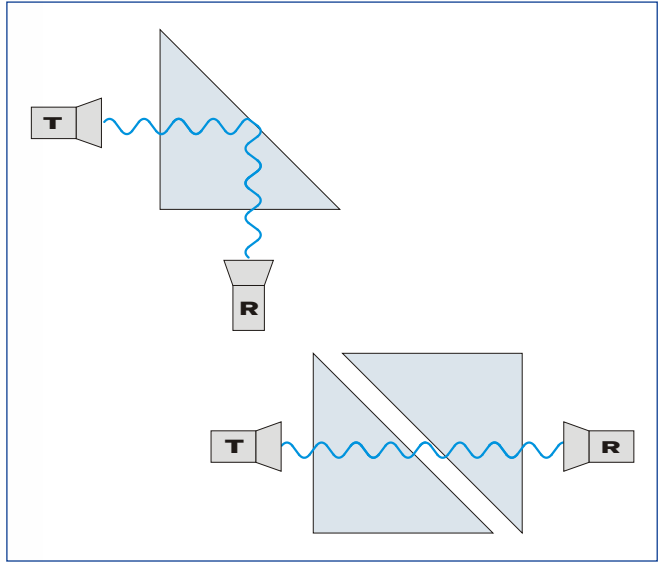

Schematic for tunnelling effect (T: Transmitter, R: Receiver)

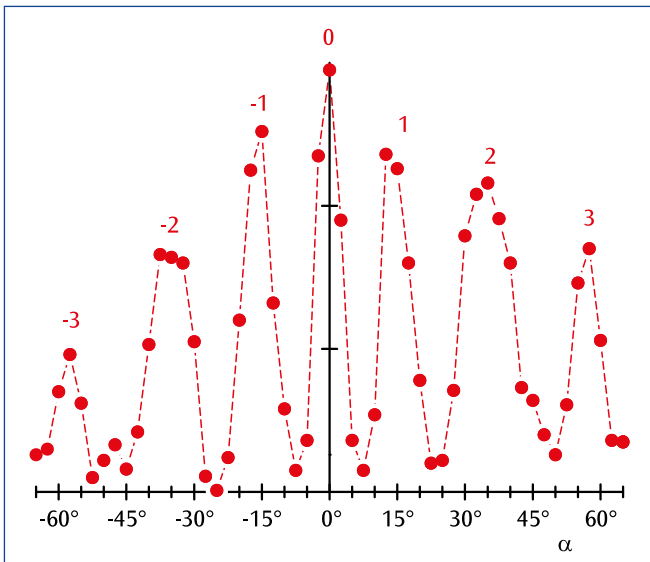

Intensity distribution resulting from the diffraction of microwaves at a pair of slits

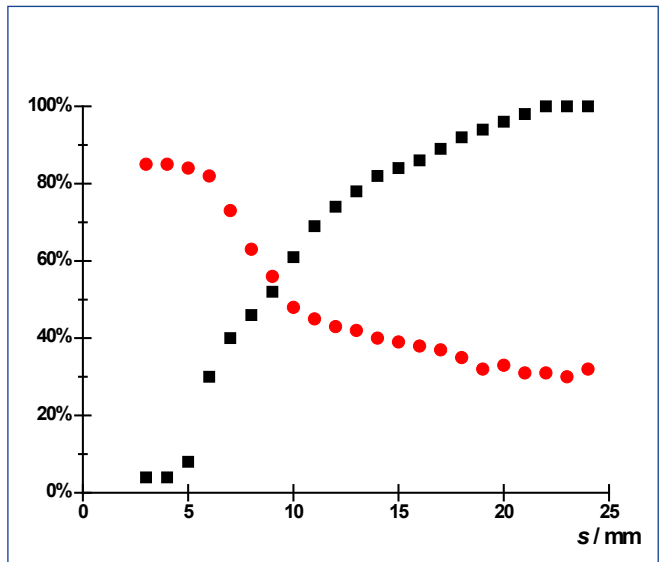

Relative intensity as a function of distance between the paraffin prisms

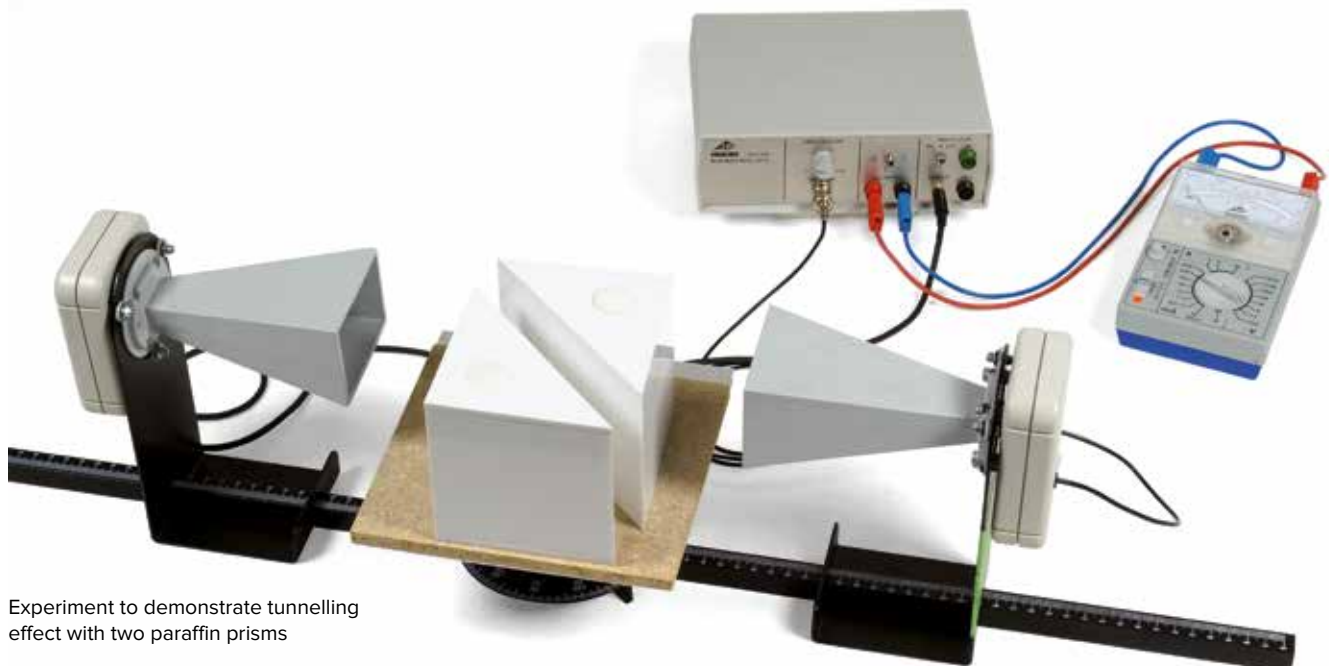

Experiment to demonstrate tunnelling effect with two paraffin prisms

Experiment Topics:

- Generation of circular and straight waves
- Reflection
- Refraction
- Diffraction
- Interference
- Doppler effect

Ripple Tank PM02

Equipment set with ripple tank for demonstrating and investigating properties of waves using the example of waves in water. The ripple tank is a shallow tank with a glass floor inside an aluminium frame, which can be filled with water. The tank can be aligned such that it is horizontal by means of adjustable feet. It is possible to generate both circular or straight waves in the tank by means of localised oscillations in air pressure and the frequency and amplitude of those waves can be set up using a control unit. An external counter can be connected to the control unit in order to measure frequency. An LED lighting system illuminates the ripple tank from above and takes the form of a stroboscope for which both asynchronous and synchronous frequencies can be set. Underneath the tank, there is an inclined mirror which projects the waves onto a viewing screen. Includes a drawer for storage of accessories and carrying handles for transport. Includes 12 V AC plug-in power supply.

Frequency range: Continuously adjustable, 1 – 60 Hz
 Stroboscope lighting: LED
 Terminals for frequency counter: 4-mm safety sockets
 Power supply: 100 – 240 V plug-in power supply
 Dimensions of tank structure: 400x300x320 mm³
 Dimensions of projection screen: 375x320 mm²

Contents:

- 1 Ripple tank with projection mirror, viewing screen and lighting system
- 1 Control unit
- 1 Plug-in power supply
- 1 Module for generating straight waves
- 1 Module for generating circular waves
- 1 Module for generating two interfering circular waves
- 1 Long hose
- 3 Obstructing bodies for reflection and refraction (prism, biconcave lens and biconvex lens)
- 4 Obstructing bodies for setting up a single slit and a double slit
- 1 Drainage hose

U219101



U219101



Refraction of water waves at a converging lens



Reflection of water waves at a "concave mirror"



Drawer for accessories on the back

Experiment Topics:

- Excitement of periodic and non-periodic waveforms
- Deflection, phase and amplitude
- Frequency and wavelength
- Phase and group velocities
- In-phase and out-of phase superimposition of waves
- Reflection of a wave
- Standing waves

Water Wave Channel

Wave channel for demonstrating or investigating the basic properties of waves using waves in water. An acrylic duct is filled with water and a sinusoidal wave is generated that propagates with no reflection at the end thanks to an absorber mechanism. The frequency and thus the wavelength of the resulting movement can be varied continuously. In order to investigate reflection, the absorber at the end can be removed. Two exciting mechanisms are supplied that can be operated in or out of phase and the waves they generate can be viewed separately or superimposed. By applying a pulsed input to the exciters, non-periodic waves can be generated.

Supply voltage: 9 – 12 V DC
 Power consumption: 40 W max.
 Connectors: 4 mm safety sockets
 Frequency range: Continuously adjustable
 Dimensions: approx. 1500x150x290 mm³
 Weight: approx. 12.6 kg

U8431411

Additionally required:

U33020-230 DC Power Supply 0 – 20 V, 0 – 5 A (230 V, 50/60 Hz)

or

U33020-115 DC Power Supply 0 – 20 V, 0 – 5 A (115 V, 50/60 Hz)

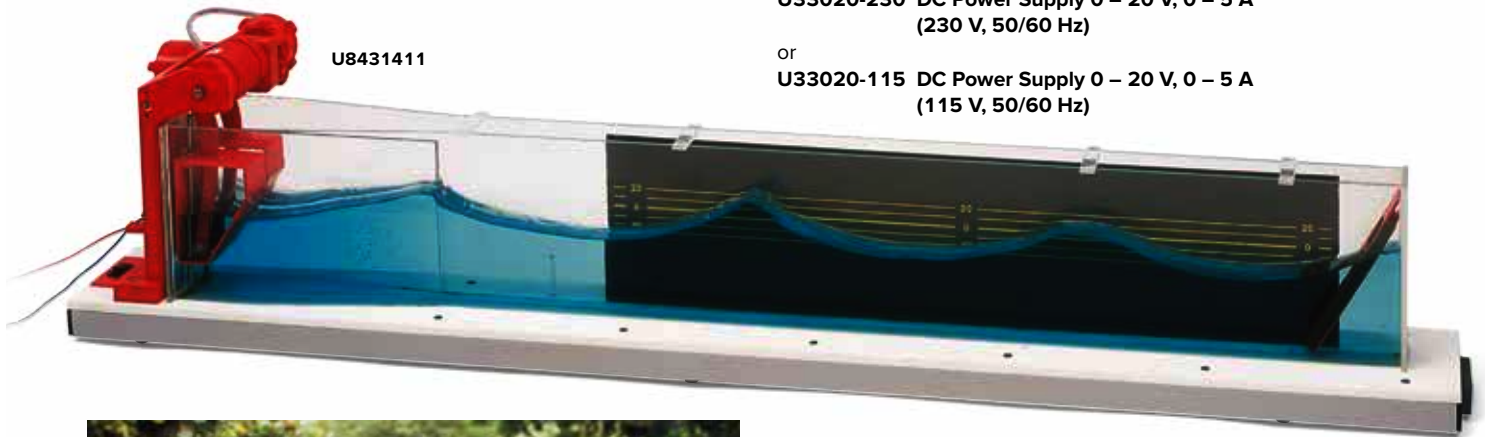

U8431411



U30034

Helical Spring Snakey

Very long helical spring for demonstrating and investigating transverse and longitudinal waves.

Length: 2 m up to 14 m
 Total number of turns: 1300
 Coil diameter: 25 mm
 Weight: 1400 g

U30034

Coil Spring Slinky

Long coil spring for demonstrating the propagation and reflection of longitudinal waves.

Length: 0.2 m up to 5 m
 Total number of turns: 330
 Coil diameter: 70 mm
 Weight: 550 g

U8405830

U8405830



Accessories for Spring Oscillations

Accessories ideal for vibration generator (U56001) for demonstrating standing longitudinal waves in a coil spring. Consisting of angled stand rod, coil spring and connector pin for attachment of the spring to the vibration generator.

Rod: 450 mm x 8 mm diam.
Spring constant: 3.9 N/m

U56003

Additionally required:
U56001 Vibration Generator

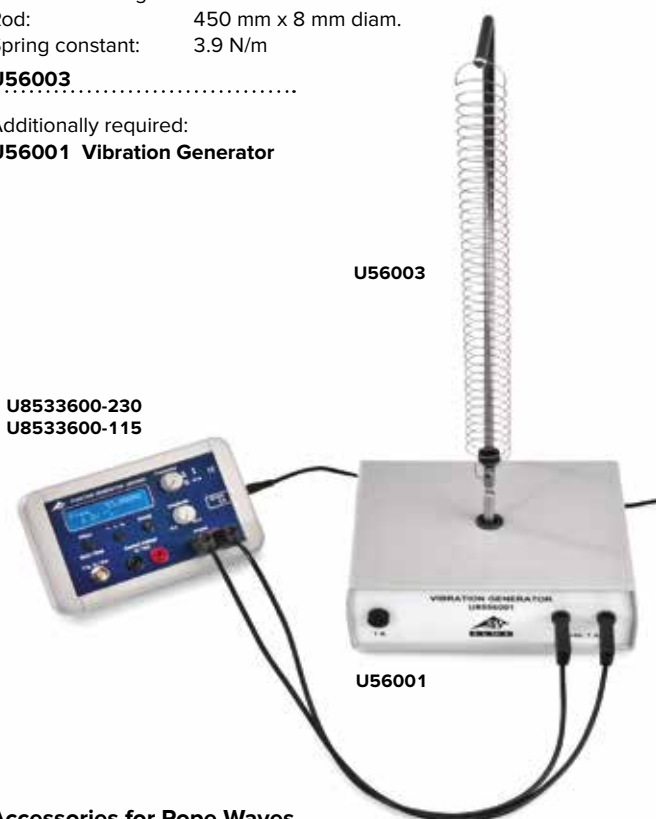

Resonance Wire, Ring Shaped

Accessories for vibration generator (U56001) for demonstrating the vibration knots in determination of different frequencies. Wire ring with 4 mm plugs.

Diameter: 290 mm

U56007

Additionally required:
U56001 Vibration Generator

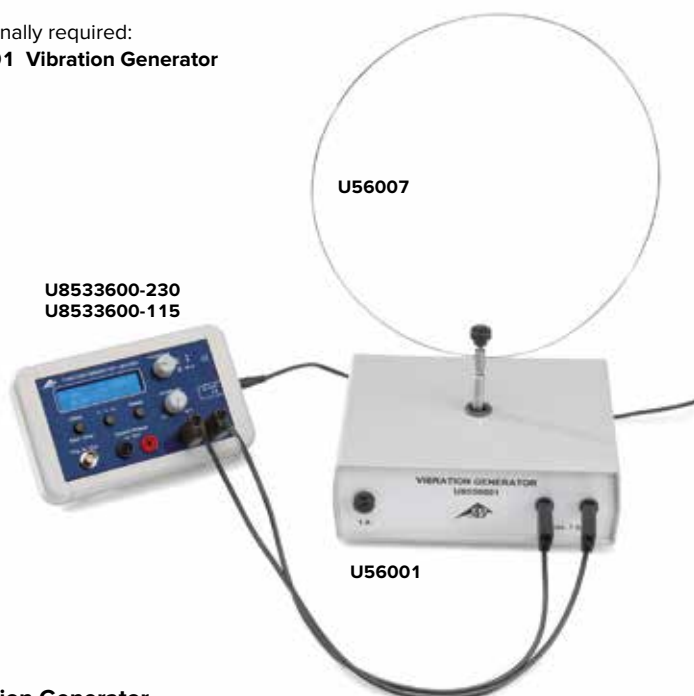

Accessories for Rope Waves

Accessories ideal for vibration generator (U56001) for the investigation of standing transversal waves and their wavelengths as a function of the rope tension and the frequency. Consisting of a base plate with stand rod, holder for dynamometer, deflection device and rubber rope.

Rope: 1 m
Base plate: approx. 180x180x25 mm³

U85560081

Additionally required:
U56001 Vibration Generator
U20034 Dynamometer 5 N

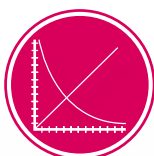

UE1050700
PDF online



Vibration Generator

Tough vibration generator for exciting oscillations and waves mechanically, e.g. in coil springs, a rubber cord, a wire ring or a Chladni plate. In robust plastic housing including mounting pin with 4 mm socket for attaching accessories (Chladni plates, resonance wire, rubber band etc.). Including holder for stand rod (up to 8 mm diam.) on the rear side of the apparatus for the demonstration of standing waves in a coil spring. The generator is equipped with overload protection.

Connection: via 4 mm safety sockets
Impedance: 8 Ω
Frequency range: 0 up to 20 kHz
Overload protection: 1 A fuse
Dimensions: approx. 200x160x70 mm³
Weight: approx. 1.4 kg

U56001

Additionally required:
U8533600-230 Function Generator FG 100 (230 V, 50/60 Hz)
or
U8533600-115 Function Generator FG 100 (115 V, 50/60 Hz)

Rubber Band

For demonstrating stationary waves and wave propagation e.g. Using the vibration generator (U56001). Wound on a board, 25 m, 2 mm diam.

U56002

Additionally required:
U56001 Vibration Generator



Chladni's Plates

Inexpensive metal plates for generating acoustically excited figures in fine dry sand, as in the experiment by Chladni. To be used for instance in conjunction with vibration generator (U56001). With 4 mm plugs.

Chladni Plate, circular, 240 mm diam.

U56005

Chladni Plate, square, 180x180 mm²

U56006

Additionally required:
U56001 Vibration Generator



DC Motor 12 V

Compact experiment motor – can also be used as a tachogenerator, oscillation generator or for the excitation of rope waves. The motor has a coreless rotor and thus has a high starting torque at a lower moment of inertia. It is characterised by a very short starting time, smooth running and low running noise. On its axis, the motor has a threaded bush with a screw on retaining pulley. Thus, plates and levers can also be fixed on to the axis.

Nominal voltage/current: 12 V/260 mA DC

Run-up voltage/current: 0.5 V/45 mA DC

Power consumption: 3.6 W

Nominal speed 3900 rpm

Nominal rated torque: 0.5 Ncm

Direction of rotation: reversible

Connection: via 4-mm safety sockets

Dimensions in mm: approx. 130x55 mm²

Weight: approx. 200 g

U8552330



Band Wave Device

Robust apparatus for demonstrating transverse standing waves on a rope and investigating how wavelength depends on the tension in the rope and on the frequency.

Dimensions: 700x150x230 mm³

Weight: approx. 4.4 kg

Contents:

- 1 Chassis
- 1 Rubber cord
- 1 Pulley
- 1 Axle clip
- 2 Axle rods
- 2 Universal clamps
- 2 Stand rods, 400 mm
- 1 Dynamometer, 5 N

U8431776

Additionally required:

U8552330 DC Motor 12 V

U8533550 Sine-Wave Generator

U8475470-230 Transformer 12 V, 25 W (230 V, 50/60 Hz)

or

U8475470-115 Transformer 12 V, 25 W (115 V, 50/60 Hz)



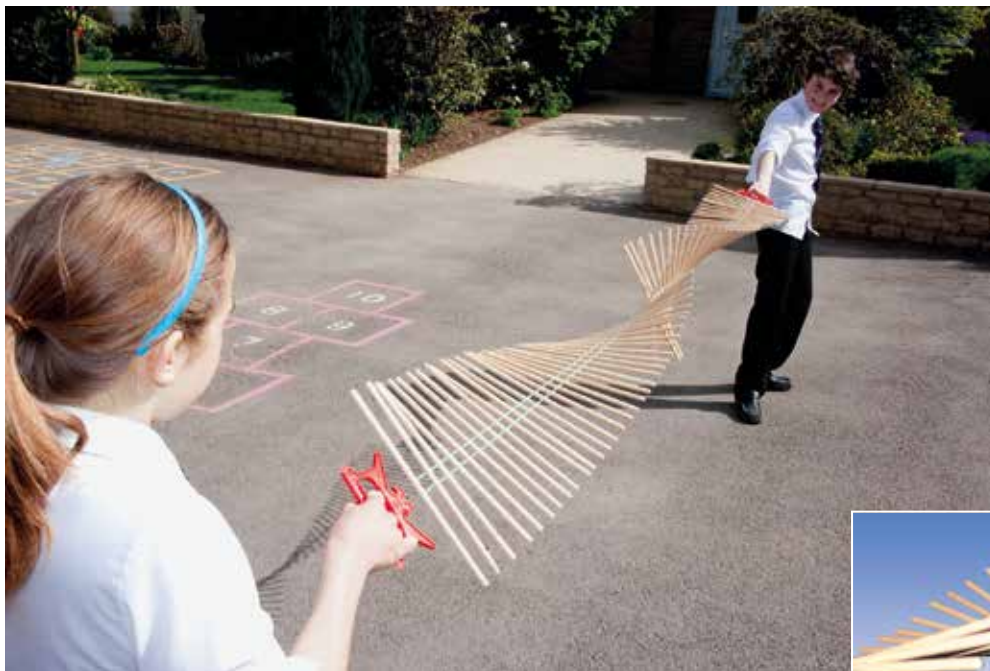

Wave Machine, Manual

Demonstration equipment for displaying propagation, reflection, diffraction and superimposition of transverse waves. A chain of wooden double-ended pendulums joined together by a bifilar thread. Two handles allow the chain to be held by hand and excited.

Number of double pendulums: 79
 Length: 3 m
 Weight: approx. 0.8 kg

U8431805



U8431805

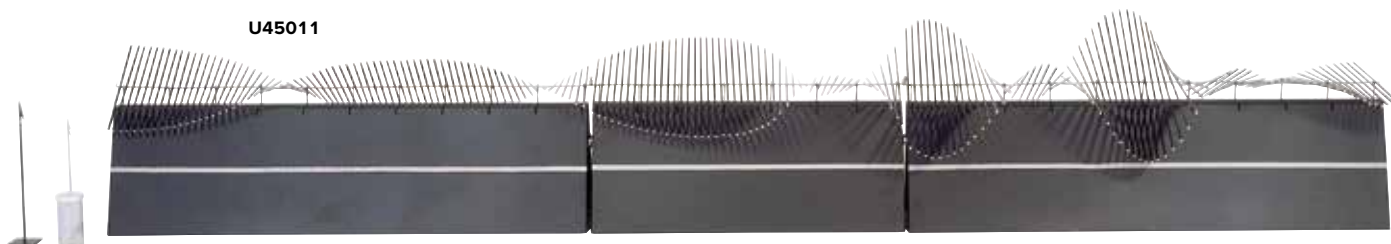

U45011

Experimental Topics:

- Propagation of a moving wave
- Wavelength, frequency and phase velocity
- Reflection of waves at fixed or moving ends
- Standing waves and resonance in the case of fixed or moving ends
- Constructive and destructive reinforcement of waves
- Propagation and speed of communication for a disturbance of equilibrium.
- Reflection of a disturbance of equilibrium at fixed or moving ends
- Damping of moving waves
- Reflection at a transition (experiment only possible with full set)
- Coupling at a transition (experiment only possible with full set)

Demonstration Wave Machine, Complete Set

Supplement to the demonstration wave machine comprising a module with short pendulum bars, a transition module and two module couplers. If the two models with differing bar lengths and thus differing wave velocities are coupled together, then reflections can be observed at the point where they are joined together. This can be avoided by adding the transition module.

Length of bar module 1: 460 mm
 Length of bar module 2: 230 mm
 Length of bars for transition module: 230 – 460 mm
 Total length: 2440 mm

U45011

Demonstration Wave Machine, Single Module

Wave machine for conducting various demonstration experiments to show the behaviour and properties of transverse waves. The motion of the wave is demonstrated by a chain of 73 steel pendulum bars each soldered at their mid-point along a rod spring that can be subjected to torsion. The ends of the bars are painted on one side in fluorescent paint and on the other side with white paint. The machine is mounted on a foldable steel base. A damping mechanism is also supplied and a retaining clamp on a stem for demonstrating reflections at a fixed end.

Number of bars: 73
 Length of bars: 460 mm
 Total length: 920 mm

U45012

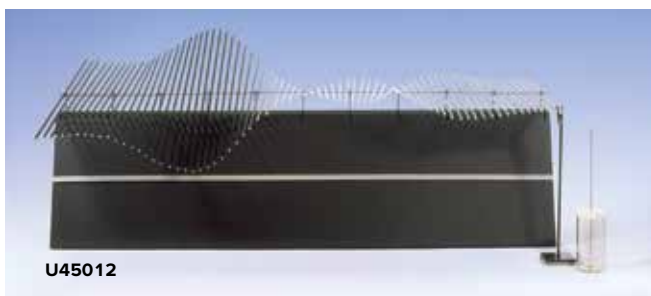

U45012

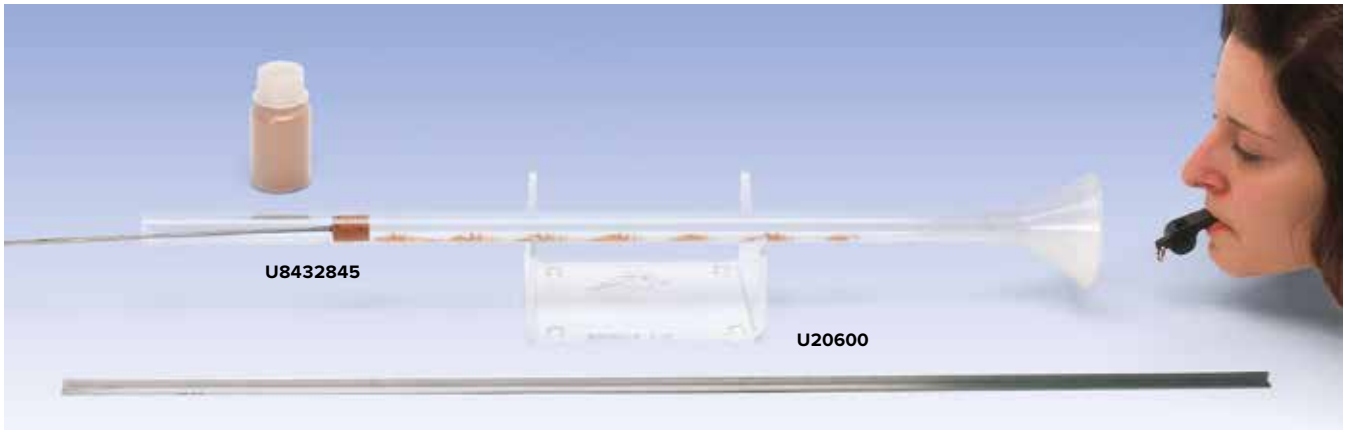

Kundt's Tube

Glass tube for demonstrating standing sound waves and calculating wavelengths of sound using cork powder in a method devised by Kundt. Cork powder is spread evenly throughout the tube by means of a filler chute. Then a sound source, e.g. a whistle, a 1700 Hz tuning fork (U10115) or a horn speaker (U8432680), is used to excite the powder into a regular pattern of nodes and antinodes. The effective length of the tube can be altered by means of a piston.

Length: 600 mm
 External diameter: 20 mm
 Internal diameter: 17 mm

Contents:

- 1 Glass tube with funnel
- 1 Plunger
- 1 Filler chute
- 1 Whistle
- 1 Bottle of cork powder

U8432845

Additionally recommended:
U8496150 Acrylic Stands

U8432850



Cork Powder, 10 g Bottle

Fine cork powder for use in Kundt's glass tube (U8432845).

U8432850

structive or destructive interference. Audible resonances occur when the length of the oscillating column of air is an odd integer multiple of a quarter wavelength of the sound.

Height of resonance tube: 1 m
 Diameter of resonance tube: 3 cm
 Scale: 98 cm
 Divisions: 1 mm
 Height of expansion vessel: 24 cm
 Diameter of expansion vessel: 7 cm
 Weight (without accessories and stands): 3.3 kg approx.

Contents:

- 1 Resonance tube with scale
- 1 Expansion vessel
- 1 Silicone tube
- 2 Horizontal clamps
- 1 Standard tuning fork, a1 = 440 Hz
- 1 Beater

U8557190

Additionally required:

- U15004 Stainless Steel Rod, 1000 mm**
- U8611160 Stand Base, A-Shaped, 200 mm**
- U13255 Universal Clamp**



Experimental Topics:

- Resonances in an oscillating column of air
- Standing sound waves
- Determination of wavelengths of sound waves in air
- Determination of speed of sound in air

new

Quincke's Resonance Tube

Quincke's resonance tube is used for demonstrating interference effects in standing sound waves. The equipment set consists of a resonance tube with a millimetre scale which is partially filled with water and is connected to an expansion vessel with a tube. The column of air above the water is excited to oscillate by using a tuning fork (or optionally a loudspeaker). By raising the expansion tank, the level of water inside the tube can be raised as well, which therefore reduces the height of the air column. The sound wave emitted by a sound source above the one open end of the tube is superimposed on the wave reflected from the surface of the water which results in con-

Experiments on Sound Waves and the Speed of Sound

Determination of the speed of sound by measuring the time it takes for a sound pulse to cover a given distance in air and in other gases

Number / Description	Art. No.
1 Kundt's tube E	U8498308
1 Pulse box K	U8498281
1 Microphone probe, long	U8498282
1 Microphone probe, short	U8498307
1 Microphone box (230 V, 50/60 Hz)	U8498283-230
or	
1 Microphone box (115 V, 50/60 Hz)	U8498283-115
1 Microsecond counter (230 V, 50/60 Hz)	U8498285-230
or	
1 Microsecond counter (115 V, 50/60 Hz)	U8498285-115
2 HF patch cords, BNC/4-mm plugs	U11257
1 Pair of safety experiment leads	U13812
A variety of technical gases, if required	

Determine the speed of sound by measuring the time it takes for a sound pulse to cover a given distance as a function of temperature

Number / Description	Art. No.
1 Kundt's tube E	U8498308
1 Pulse box K	U8498281
1 Microphone probe, long	U8498282
1 Microphone probe, short	U8498307
1 Microphone box (230 V, 50/60 Hz)	U8498283-230
or	
1 Microphone box (115 V, 50/60 Hz)	U8498283-115
1 Microsecond counter (230 V, 50/60 Hz)	U8498285-230
or	
1 Microsecond counter (115 V, 50/60 Hz)	U8498285-115
1 Heating rod K	U8498280
1 DC power supply, 0 – 20 V, 0 – 5 A (230 V, 50/60 Hz)	U33020-230
or	
1 DC power supply, 0 – 20 V, 0 – 5 A (115 V, 50/60 Hz)	U33020-115
1 Digital Quick-Response pocket thermometer	U11853
1 K-Type NiCr-Ni Immersion Sensor, -65° C to 550° C	U11854
2 HF patch cords, BNC/4-mm plugs	U11257
2 Pairs of safety experiment leads	U13812

Quantitative investigations of standing waves in closed and open tubes – Determination of the speed of sound from wavelength and frequency

Number / Description	Art. No.
1 Kundt's tube E	U8498308
1 Microphone probe, long	U8498282
1 Microphone box (230 V, 50/60 Hz)	U8498283-230
or	
1 Microphone box (115 V, 50/60 Hz)	U8498283-115
1 Function generator FG 100 (230 V, 50/60 Hz)	U8533600-230
or	
1 Function generator FG 100 (115 V, 50/60 Hz)	U8533600-115
1 Analogue Multimeter ESCOLA 30	U8557330
1 Pair of safety experiment leads	U13812
1 HF patch cord, BNC/4-mm plugs	U11257

Frequency analysis of standing waves in a closed tube

Number / Description	Art. No.
1 Kundt's tube E	U8498308
1 Microphone probe, long	U8498282
1 Microphone box (230 V, 50/60 Hz)	U8498283-230
or	
1 Microphone box (115 V, 50/60 Hz)	U8498283-115
1 Function generator FG 100 (230 V, 50/60 Hz)	U8533600-230
or	
1 Function generator FG 100 (115 V, 50/60 Hz)	U8533600-115
1 USB oscilloscope 2x50 MHz	U112491
1 HF-Patch Cord	U11255
1 HF patch cord, BNC/4-mm plugs	U11257
1 Pair of safety experiment leads	U13812

Determination of the time it takes for sound pulses to travel given distances in an enclosed space

Number / Description	Art. No.
1 Microphone probe, short	U8498307
1 Microphone box (230 V, 50/60 Hz)	U8498283-230
or	
1 Microphone box (115 V, 50/60 Hz)	U8498283-115
1 Microsecond counter (230 V, 50/60 Hz)	U8498285-230
or	
1 Microsecond counter (115 V, 50/60 Hz)	U8498285-115
1 Connecting Lead with Two Metal Rods	U8498287
1 Pocket Measuring Tape, 2 m	U10073
1 HF-Patch Cord, BNC/4-mm plugs	U11257

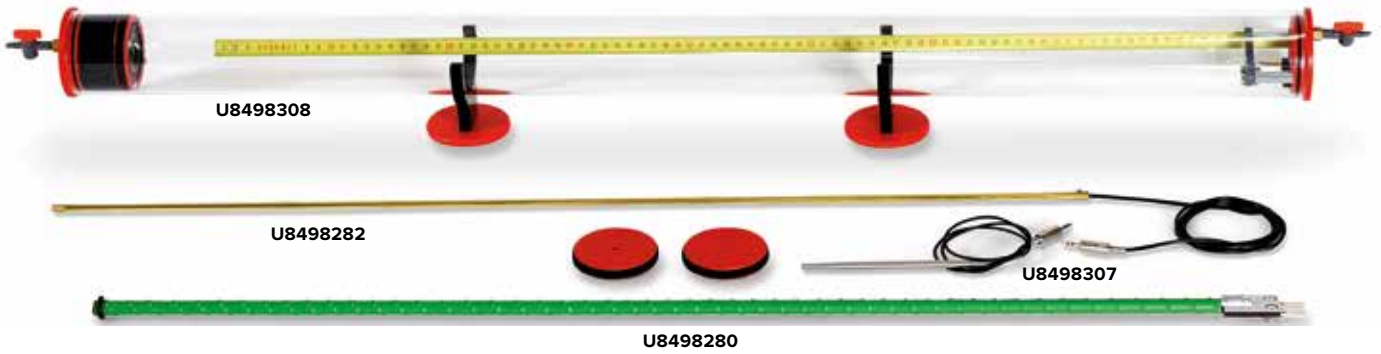

Kundt's Tube E

Sound tube made of transparent acrylic with loudspeaker and movable scale for quantitative investigation of sound waves in air or other gases, in particular for measurement of wavelength and speed of sound. With two stand bases, capillary disc, sensor disc, two hose connectors with stopcock for filling with gas, fitting and guide for long microphone probe, hole for short microphone probe, plus holder and connector for heating rod K.

Frequency range:	20 to 5000 Hz
Length of sound tube:	1000 mm
Diameter of sound tube:	70 mm
Scale:	950 mm
Hose connectors:	5 mm diameter
Speaker power output:	3 W
Impedance of speaker:	50 Ω
Weight:	1.25 kg approx.

U8498308

Heating Rod K

Heating rod for warming air in Kundt's tube E up to about 50°C.

Operating voltage:	max. 12 V
Power consumption:	36 W
Temperature in Kundt's tube:	max. 50°C
Connectors:	Pair of 4-mm plugs
Dimensions:	900 mm x 11 mm mm diam. approx.

U8498280

Additionally required:

U33020-230 DC power supply, 0 – 20 V, 0 – 5 A
(230 V, 50/60 Hz)

or

U33020-115 DC power supply, 0 – 20 V, 0 – 5 A
(115 V, 50/60 Hz)

Microphone Probe, Long

Miniature microphone at the end of a long rod for measuring changes in sound pressure in Kundt's tube E. With thread for attaching probe disc of Kundt's tube E.

Frequency range:	20 Hz – 16 kHz
Diameter of rod:	6 mm
Length of rod:	900 mm
Connecting lead:	1 m approx., with 3.5-mm jack plug

U8498282

Microphone Probe, Short

Miniature microphone at the end of a short rod for measuring changes in sound pressure.

Frequency range:	20 Hz – 16 kHz, (1 – 20 Hz and 16 – 42 kHz, non-specified tolerance range)
Diameter of rod:	6 mm
Length of rod:	140 mm
Connecting lead:	0.6 m approx., with 3.5-mm jack plugs

U8498307

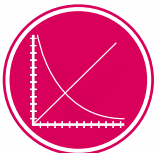

UE1070310
PDF online

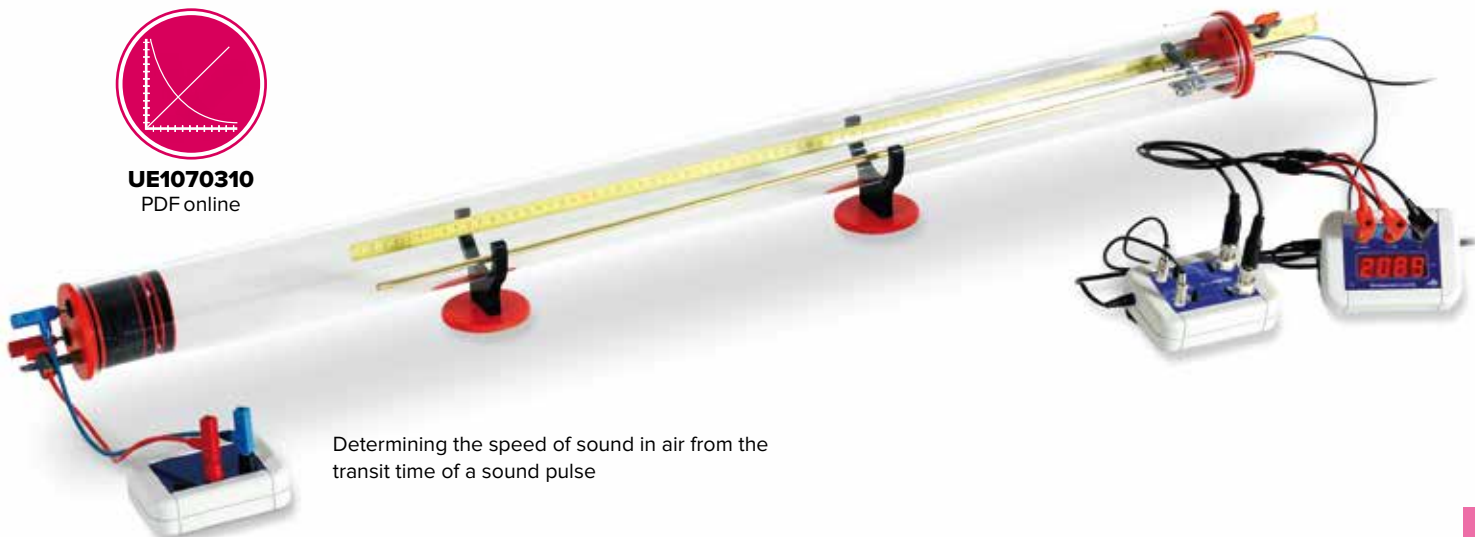

Determining the speed of sound in air from the transit time of a sound pulse

Microsecond Counter

Easy to use counter for measuring time in microseconds. Particularly well suited for measurements made in conjunction with the microphone box. Includes 12 V AC plug-in power supply. The counting procedure is started via the Start input and halted by means of the Stop input. Each new start causes the counter to automatically reset to zero. Both inputs respond to a rising edge and are equipped internally with pull-up resistors.

- Measuring range: 1 – 9999 μ s
- Resolution: 1 μ s
- Precision: Quartz precision
- Internal resistance: 2.4 k Ω (Start input), 5.6 k Ω (Stop input)
- Switching edges for both inputs: Rising edge
- Display: 4-digit LED
- Connectors: 4-mm safety sockets
- Power supply: 12 V AC, 500 mA plug-in power supply
- Dimensions: 100x75x35 mm³ approx.
- Weight: 400 g approx. including plug-in supply

Microsecond Counter (230 V, 50/60 Hz)

U8498285-230

Microsecond Counter (115 V, 50/60 Hz)

U8498285-115



U8498285-230
U8498285-115



U8498283-230
U8498283-115

Microphone Box

All-purpose dual-channel amplifier for long or short microphone probes. Particularly suitable for use with microsecond counters in experiments for determining speed of sound, including 12 V AC plug-in power supply. Both channels can be individually switched between the operating modes, "Signal" for connecting an oscilloscope, "Level" for connecting a voltmeters and "Pulse" for connecting a microsecond counter. The trigger threshold for the pulse depends on the gain of the pre-amp, which is adjustable.

- Band width: 10 Hz to 42 kHz
- Gain: 20 to 70x
- Output impedance: 1 k Ω
- Output signal: Switchable between Signal, Level and Pulse
- Signal: 0 – 14 Vpp
- Level: 0 – 7 V DC
- Pulse: Low: 0 V, high: 8 V DC, length: 150 ms
- Inputs: 3.5 mm jack plugs
- Outputs: BNC socket
- Power supply: Via 12 V AC, 500 mA plug-in power supply
- Dimensions: 100x75x35 mm³
- Weight, including power supply: 450 g approx.

Microphone Box (230 V, 50/60 Hz)

U8498283-230

Microphone Box (115 V, 50/60 Hz)

U8498283-115

Additionally required:
U8498282 Microphone probe, long
or
U8498307 Microphone probe, short



U8498287

Connecting Lead with Two Metal Rods

Pair of metal rods with a connecting lead for use with the microphone box in order to start measurements of time for the sound pulses in free space.

- Length of lead: 75cm
- Connectors: 2x 4-mm safety plugs, 3.5mm-jack plug
- Rods: 110 mm x 10 mm diam.

U8498287



U8498281

Pulse Box K

Electronic switch which outputs an electrical pulse to a connected speaker at the press of a button. Power supplied via 9 V block battery.

- Dimensions: 100x75x35 mm³ approx.

U8498281

Experiment Topics:

- Speed of propagation of sound pulses in various rods
- Comparison between the propagation of longitudinal and transverse waves
- Standing sound waves in short rods
- Polarity of reflections at the ends of the rods
- Multiple reflection at the ends of longer rods

U8557180-230
U8557180-115



Sound

Advantages

- Compact set-up on lab benches
- Non-contact and low-attenuation measurement of sound waves

Equipment Set "Sound Propagation in Rods"

Equipment set for investigating propagation of sound and determining the speed of sound in solid rods of various materials. The set includes various test rods, two microphone probes and a microphone box for connection to an oscilloscope. Contained in a sturdy plastic case with foam inlays in the shape of the apparatus and a transparent lid.

Contents:

- 6 Test rods, 200 mm, made of glass, transparent acrylic (perspex), PVC, wood (beech), stainless steel and aluminium
- 4 Test rods, 100 mm, made of copper, brass, stainless steel and aluminium
- 1 Test rod, 400 mm made of stainless steel
- 2 Beaters
- 2 Microphone probes
- 1 Microphone boxes
- 1 Plug-in power supply 12 V AC
- 3 Rubber mats, 50x40x5 mm³

Equipment Set "Sound Propagation in Rods" (230 V, 50/60 Hz)

U8557180-230

Equipment Set "Sound Propagation in Rods" (115 V, 50/60 Hz)

U8557180-115

Additionally required:

Dual-channel oscilloscope, e.g.

U112491 USB Oscilloscope, 2x50 MHz

Experiment Topics:

- Directions of sound
- Determining differences in time for sound to propagate to left and right ears
- Effect of linear distortions on cavity resonance

Equipment Set "Stereophonic Hearing"

Equipment set for investigation of directionality of sound and determining differences in time for sound to propagate to left and right ears by generation of knocking sounds in a closed tube. The effect of linear distortions on the directionality of cavity resonance can also be investigated by dipping two ends of a tube, at the same time or in alternation, into a beaker which is either empty or half-filled with water. The set consists of a stethoscope with various tubes and a plastic beaker in a rugged plastic case with foam inlays in the shape of the apparatus and a transparent lid.

Contents:

- 1 Stethoscope
- 2 Spare earpieces
- 1 Tube, 1 m
- 2 Tubes, 0.5 m
- 2 Toothpicks
- 1 Plastic beaker
- 1 Storage case

U8557320

Additionally recommended:

U8498307 Microphone Probe, Short (2x)

U8498283-230 Microphone Box (230 V, 50/60 Hz)

or

U8498283-115 Microphone Box (115 V, 50/60 Hz)

U8498285-230 Microsecond Counter (230 V, 50/60 Hz)

or

U8498285-115 Microsecond Counter (115 V, 50/60 Hz)

U11257 HF Patch Cord, BNC/4-mm Plug (2x)



U8557320



Waves and Sound



U55001

Demonstration Tuning Fork

Large tuning fork for demonstrating the vibrating legs of the fork.

Length: 750 mm

U55001

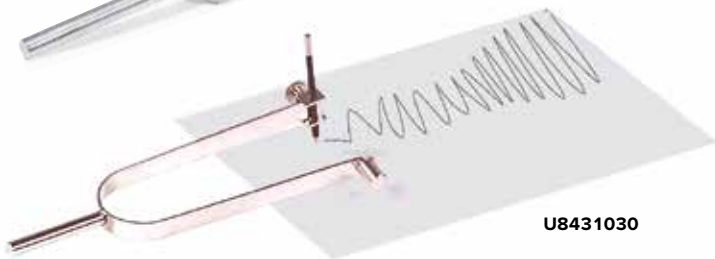

U8431030

21 Hz Tuning Fork with Plotter Pen

Tuning fork that allows for plotting oscillations on a sheet of paper. The oscillation is triggered by pushing the prongs of the fork together. The oscillation of the tuning fork is highly visible both with the naked eye or with the aid of a stroboscope. Includes a plotter pen with holder and a counterweight.

Natural frequency: 21 Hz

Length: 245 mm

Total weight: approx. 170 g

U8431030

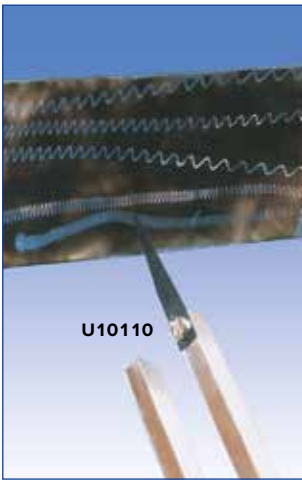

U10110

Recording Tuning Fork, c 128 Hz

For demonstrating and recording sound oscillations. For recording the oscillations on a sooted glass plate one of the two prongs is equipped with a metal tip. Complete with a glass plate.

Natural frequency: 128 Hz

Total length: approx. 280 mm

Glass plate: 120x50 mm²

U10110



U10117

Tuning Fork, 2000 Hz

Tuning fork with handle for demonstrating the Doppler Effect. The effect can be exhibited very impressively by moving the fork slowly toward and away from the audience.

Natural frequency: 2000 Hz

Length of the tuning fork: 220 mm

U10117

Additionally recommended:

U10118 **Hard Striking Hammer**



U10110



U10116

Light Metal Tuning Fork, 1700 Hz

Suitable as a source of intense, high-frequency sound, for example, for producing stationary sound waves in Kundt's tube.

Natural frequency: 1700 Hz

Length: approx. 105 mm

U10115

Light Metal Tuning Fork, 1000 Hz

Suitable as a source of intense, high-frequency sound, for example, for producing stationary sound waves in Kundt's tube.

Natural frequency: 1000 Hz

Length: approx. 115 mm

U10116

Tuning Fork, 440 Hz, on Resonance Box

Long-sustain tuning fork mounted on a resonant chamber made of clear grained fir wood. Removable, includes a soft striking hammer (U10122).

Natural frequency: 440 Hz

Length of the tuning fork: approx. 170 mm

Resonance box: 180x90x50 mm³

U10121



U10121

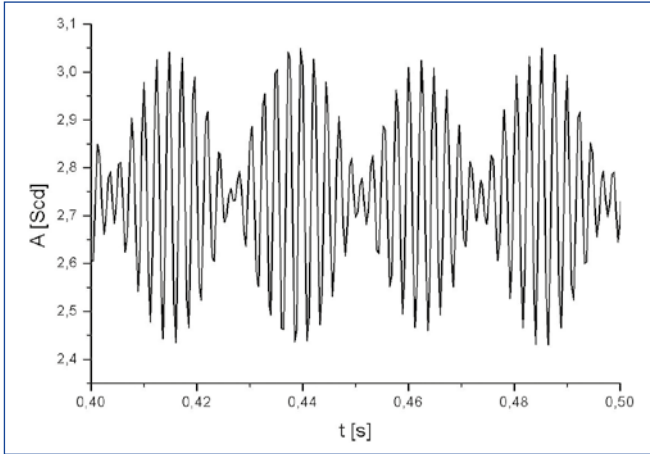

Acoustic beats

Pair of Tuning Forks, 440 Hz, on Resonance Boxes

Pair of Tuning Forks for experiments on beats; the tuning forks are identical with U10121. Complete with a soft striking hammer (U10122) and a pair of tuning weights (U10119).

U10120

Set of Tuning Forks, C-Major Chord, on Resonance Boxes

Set of four tuning forks for demonstrating C major chord. Supplied on a sound box made of clear grained pine for especially long sustain from which the tuning forks can be removed. Includes a soft striking hammer (U10118).

Natural frequency:	Internal length:
c' = 256 Hz	300 mm
e' = 322 Hz	240 mm
g' = 384 Hz	190 mm
c'' = 512 Hz	140 mm

U10125

Set of Tuning Forks for the C-Major Scale

Set of 8 tuning forks in a storage case.

Frequencies:

- c' = 256 Hz
- d' = 288 Hz
- e' = 320 Hz
- f' = 341½ Hz
- g' = 384 Hz
- a' = 426⅔ Hz
- h' = 480 Hz
- c'' = 512 Hz

U10100

Striking Hammer, Soft

Rubber beater particularly suited for striking low-frequency tuning forks, e.g. tuning forks on sound box (U10120, U10121 and U10125).

U10122

Striking Hammer, Hard

Aluminium beater particularly suited for striking high-frequency 2000 Hz tuning fork (U10117).

U10118

Pair of Tuning Weights (not shown)

Two tuning weights for changing the frequency of tuning forks for beat experiments; intended for the 440-Hz tuning fork mounted on a resonance box (U10121).

U10119

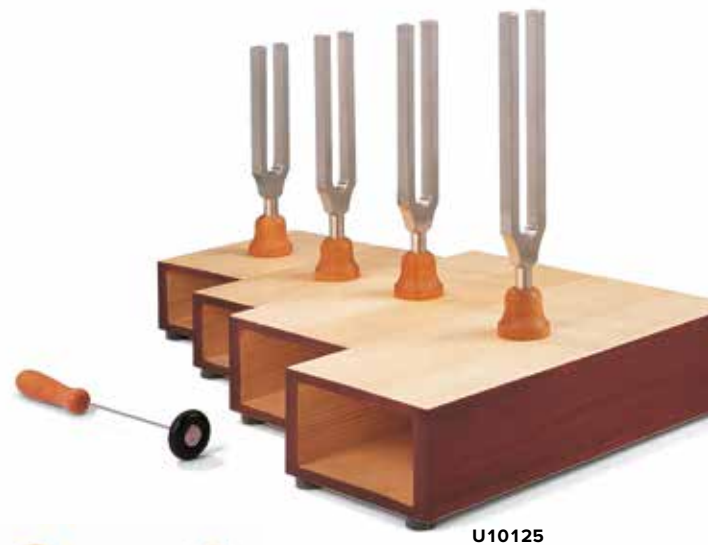

Sound

Waves and Sound

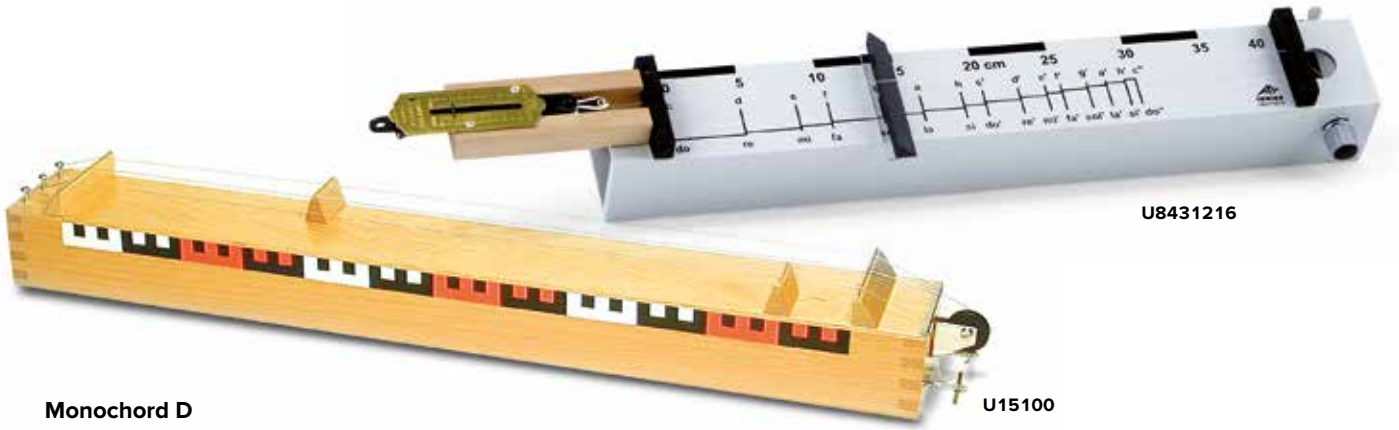

U8431216

U15100

Monochord D

Demonstration apparatus for investigating the relationship between the pitch of a sound and the length of the string making it. Also for investigating overtones formed by harmonic waves with intermediate nodes and the dependence of the pitch on string tension. Two steel strings and one nylon string are stretched over a sound box. The tension on two of the strings can be altered by tuning pegs while the other's tension can be changed by adding weights or using a dynamometer at the end of a cord passed over a pulley. The effective length of the strings can be altered by means of two moving bridges.

- Scale length: 600 mm
- Scale division: cm and dm
- Dimensions of the resonance box: approx. 700x90x70 mm³

U15100

Additionally recommended:
U40815 Dynamometer 50 N

Set of 3 Monochord Strings (not shown)

Two steel and one nylon string with eyelets, fitting the monochord D (U15100).

U15101

Reed Pipe

Reed pipe with 8 valves, tuned to C major.
 Length: 37 cm
 Weight: approx. 90 g

U8430160

Helmholtz Resonator

Hollow glass bulb with a narrow tube leading out for demonstrating acoustic resonance. The fundamental oscillation is generated by blowing into the opening or tapping on the outside of the bulb. The elasticity and inertial mass of the air in the bulb cause the bulb to act as an acoustic resonator with a highly distinct resonant frequency. The frequency is dependent on the dimensions of the bulb and the tube. With a whole set of Helmholtz resonators it is possible to demonstrate how tones combine to form a tonal mixture.

- Opening on the glass bulb: 14 mm diam.
- Length of tube: 15 mm
- Internal diameter of tube: 6 mm

Helmholtz Resonator, 70 mm diam.

U8430310

Helmholtz Resonator, 52 mm diam.

U8430320

Helmholtz Resonator, 40 mm diam.

U8430330

Helmholtz Resonator, 32 mm diam.

U8430340



U8430310

U8430320

U8430330

U8430340

Monochord

A wooden box open at both ends, with a clamping mechanism for a string to demonstrate the relationship between pitch and string length and the dependence of pitch on string tension. Includes an indicator for the tensioning force, as well as a steel string (tuned to B) and a nylon string.

Dimensions: approx. 490x70x60 mm³

U8431216



U8430160

U8430185

Lip Whistle

Lip whistle for experiments on pitch as a function of resonance space. Closed wooden whistle with a round cross-section and movable piston, chromatic range from g¹ (392 Hz) to g² (794 Hz).

- Frequency range: approx. 400 Hz – 800 Hz
- Resonance space: approx. 170 mm x 20 mm diam.
- Length: approx. 250 mm

U8430185

Metallophone

Metallophone for demonstrating a C major scale from c¹ to g². Note labels, frequencies and frequency ratios are printed on the instrument. With striking hammer.

- Dimensions: approx. 320x210 mm²
- Weight: approx. 510 g

U8430290

U8430290

U8432680

Horn Speaker

Speaker that approximates to being a point source for excitation of Kundt's tube (U8432845), for example. Frequency range: 300 Hz – 10 kHz
 Max. load capacity: 8 W (max. 10 W)
 Impedance: 8 Ω
 Shaft: 10 mm diam.
 Weight: approx. 650 g

U8432680

Additionally recommended:

U8533550 Sine Wave Generator

U8475470-230 Transformer (230 V, 50/60 Hz)

or

U8475470-115 Transformer (115 V, 50/60 Hz)



Wide-Band Loudspeaker

Ideal sound source for acoustics experiments in the frequency range 60 Hz to 23 kHz. Includes connecting lead with 4 mm safety plugs.

Frequency range: 60 Hz to 23 kHz (-10 dB)

Power capacity: 100 W (as per IEC 268-5)

Impedance: 4 Ω

Tweeter: 1/2" diam.

Woofers: 5 1/2" diam.

Dimensions: 225x150x142 mm³

Weight: 1.8 kg

U8432770

Additionally recommended:

U8533550 Sine Wave Generator

U8475470-230 Transformer (230 V, 50/60 Hz)

or

U8475470-115 Transformer (115 V, 50/60 Hz)



U8432770



Recording of ultrasonic standing waves



Ultrasound Transducer, 40 kHz, Equipment Kit

Equipment set for experiments on geometric and wave-mechanical acoustics. Based on the piezo-effect discovered by the Curie brothers, an AC voltage is applied to a piezo-electric body causing it to oscillate. Sound waves can also be used to excite the body and the oscillations can be converted into an electrical voltage signal.

Resonant frequency: 40 kHz approx.

Band width: 6 kHz approx.

Capacitance: 1900 pF

Connector: BNC

Stand rod: 150 mm x 10 mm diam.

Dimensions: 40 mm x 20 mm diam.

Contents:

1 Ultrasonic transmitter, on stand rod

1 Ultrasonic receiver, on stand rod

1 Projection screen

1 Ruler, 1 m

U8552003

Equipment:

U8552003 Ultrasound Transducer, 40 kHz, Equipment Kit

U8533600-230 Function Generator FG100 (230 V, 50/60 Hz)

or

U8533600-115 Function Generator FG100 (115 V, 50/60 Hz)

U11175 Analogue Oscilloscope, 2x 30 MHz

U8611210 Barrel Foot, 0.5 kg (3x)

U11255 HF Cable

U11261 T-Piece, BNC

U11260 Adapter, BNC Jack/4-mm-Plugs



U8552003

Debye-Sears Effect

In 1932, Debye and Sears for the first time demonstrated the refraction of light as it passed through a liquid being subjected to high-frequency vibrations. In this process, the density maxima and minima of a stationary ultrasonic wave act like the elements of an optical diffraction grating. The grating constant here is equal to half the wavelength and therefore dependent on the frequency and speed of the ultrasonic waves transmitted through the medium (e.g. water, glycerin, oil).



Equipment for the Debye-Sears Effect:

U100061 Ultrasonic CW Generator with Probe

U10008 Test Vessel

U10007 Laser Diode for the Debye-Sears Effect, red

U10009 Laser Diode for the Debye-Sears Effect, green

Ultrasonic cw Generator with Probe

Ultrasonic generator for producing continuous, high-powered ultrasonic waves in a wide frequency range of up to 20 MHz. Includes a multi-frequency probe with waterproof cast sound transmitting surface. The transmitter frequency can be adjusted in digital increments of 1 Hz and is indicated on a display. The acoustic power can also be adjusted by regulating the transmitter voltage of the ultrasonic converter and can be turned on and off separately. The transmitting mode is shown by an indicator lamp. The transmitter voltage is shown on an LCD display. The transmitter output supplies a sinusoidal signal with a maximum amplitude of 46 Vpp. In addition, the transmission frequency is output in the form of a TTL signal via a BNC socket and as a generator signal (max. 2.5 Vpp) via another BNC socket. The equipment can therefore be used as a flexible signal generator. There is also a suitable voltage output for controlling the red and green laser diodes in the Debye-Sears experiment. This, too, can be turned on and off separately and has its own indicator light.

Generator frequency:	≤ 20 MHz
Multi-frequency probe:	1 – 13 MHz
Frequency increment:	1 Hz
Signal amplitude:	2 – 46 Vpp
Transmitted signal output:	Continuous wave/burst/pulse signal, separately switchable with indicator light
TTL output:	0 – 5 V, square signal
Signal generator output:	Sine, triangle, square with continuous wave, burst or pulse signal, max. 2.5 Vpp
Connection:	Laser diode, adjustable, separately switchable with indicator light
Display:	Current, voltage and frequency (continuous wave, burst, pulse) or alternatively laser voltage, signal generator voltage and signal type (sine, triangle, square), burst length and pulse repeat frequency
Mains voltage:	100 – 240 V, 50/60 Hz
Dimensions:	approx. 255x170x265 mm ³

U100061

Test Vessel, Complete

Test vessel made of glass, for conducting the Debye-Sears experiment or projecting ultrasonic waves with divergent light. Lid with probe adjustment via three adjustment screws can be used to produce a stationary wave. A laser fixture with a lens mounting aligned vertically to the sound axis. Includes a plano-convex lens on a square mounting for the projection.

Test vessel:	100x100x120 mm ³
Testing volume:	approx. 1 litre
Laser fixture:	18 mm diam.
Lens:	Plano-convex, f = 100 mm, 16 mm diam.

U10008

Laser Diode for Debye-Sears Effect, Red

Laser diode of protection classification II with 1 m connector lead and barrel connector for connecting ultrasonic cw generator (U100061). Fits the laser holder of test vessel (U10008). All lasers have been measured to determine their wavelength specifically and the results are logged.

Wavelength:	approx. 650 nm
Power:	< 1 mW
Supply voltage:	3 V DC
Current consumption:	max. 30 mA
Dimensions:	90 mm x 17 mm diam.

U10007

Laser Diode for Debye-Sears Effect, Green

Laser diode of protection classification IIIa with 1 m connector lead and barrel connector for connecting ultrasonic cw generator (U100061). Fits the laser holder of test vessel (U10008). All lasers have been measured to determine their wavelength specifically and the results are logged.

Wavelength:	approx. 532 nm
Power:	< 5 mW
Supply voltage:	3 V DC
Current consumption:	max. 250 mA
Dimensions:	90 mm x 17 mm diam.

U10009

Ultrasonic Echoscope GS200

Operational device for conducting ultrasonic experiments in reflection mode (pulse echo) or in through-transmission mode with ultrasonic probes 1 MHz (U100151), 2 MHz (U100161) and 4 MHz (U100171). With the built-in transmission and receiving unit, time gain control (TGC), integrated analogue-digital converter and microprocessor for connection to the measuring and evaluating computer via the USB interface. Connection of the ultrasonic probes via robust snap-in sockets with automatic probe recognition. Compensation for losses of intensity in ultrasonic sound pulses passing through solid or liquid bodies by means of TGC with selectable threshold, start point, end point and TGC ramp. The most important function signals (trigger, TGC, A-scan signal (amplitude signal) and ultrasound signal) are available via BNC sockets on the front of the device. Includes measurement and evaluation software for Windows operating systems. Screen display of the ultrasound signals (echogram) and the simultaneous TGC signal, whereby the A-scan signal and ultrasound signal can be recorded individually or both simultaneously in the echogram as a function of time or penetration depth. Display of all currently set system parameters (operating mode, transmission level, gain, connected ultrasound probes) calculation of frequency and cepstrum of ultrasound signal (FFT), depiction of 2-dimensional ultrasonic images (B-image) and the time characteristic of time motion reflection layers (time-motion methods). Ultrasonic probes not included in scope of delivery.

- Frequency range: 1 – 5 MHz
- Transmission signal: Dirac pulse ($< 1 \mu\text{s}$, 0 – 300 V)
- Transmission power: 0–30 dB, in 5 dB steps
- Gain: 0–35 dB, in 5 dB steps
- TGC: Continuously adjustable threshold value, start value, rise time and gain time, Maximum gain of approx. 32 dB
- Outputs (front): TGC, trigger, ultrasound signal, A-scan signal via a BNC socket in each case
- Probes connectors: 2, selectable for transmit, receive or duplex modes
- PC connection: USB
- Scanning rate: 10, 25, 50 and 100 MHz
- Power consumption: approx. 20 VA
- Mains voltage: 100 – 240 V, 50/60 Hz
- Dimensions: approx. 226x169x325 mm³

U100102

Experiment Topics:

- Propagation of longitudinal and transverse ultrasonic waves in solid bodies
- Determining velocity of longitudinal and transverse ultrasonic waves in solid bodies
- Determination of shear modulus, modulus of elasticity and Poisson number
- Attenuation of sound in solid bodies and liquids
- Frequency dependence of sound attenuation
- Time-dependent gain
- Frequency dependence of resolution
- Recording brightness images
- Recording ultrasonic echoes from moving boundaries (time-motion mode)
- Measurement of anomalies

- Equipment:
- U100102 Ultrasonic Echoscope GS200**
 - U10020 Equipment Set "Ultrasound in Solids"**
 - U100151 Ultrasonic Probe 1 MHz, GS200 (2x)**

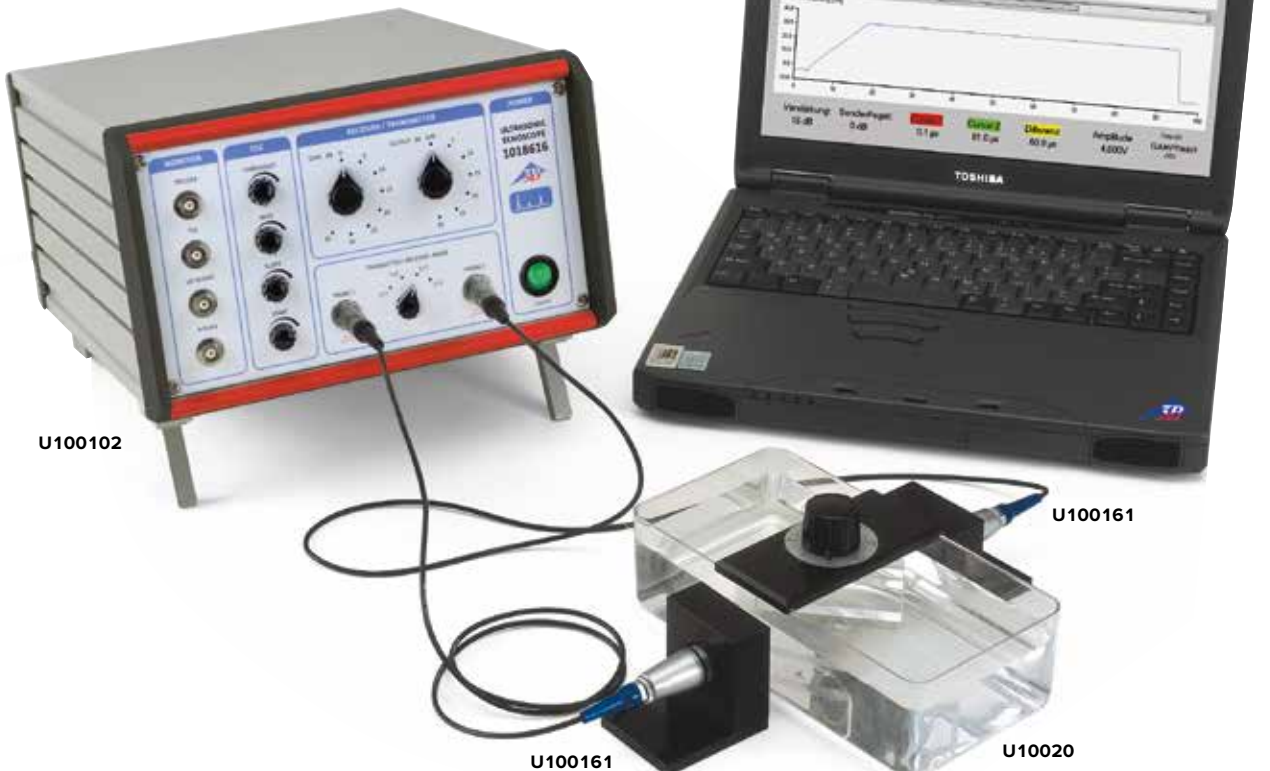

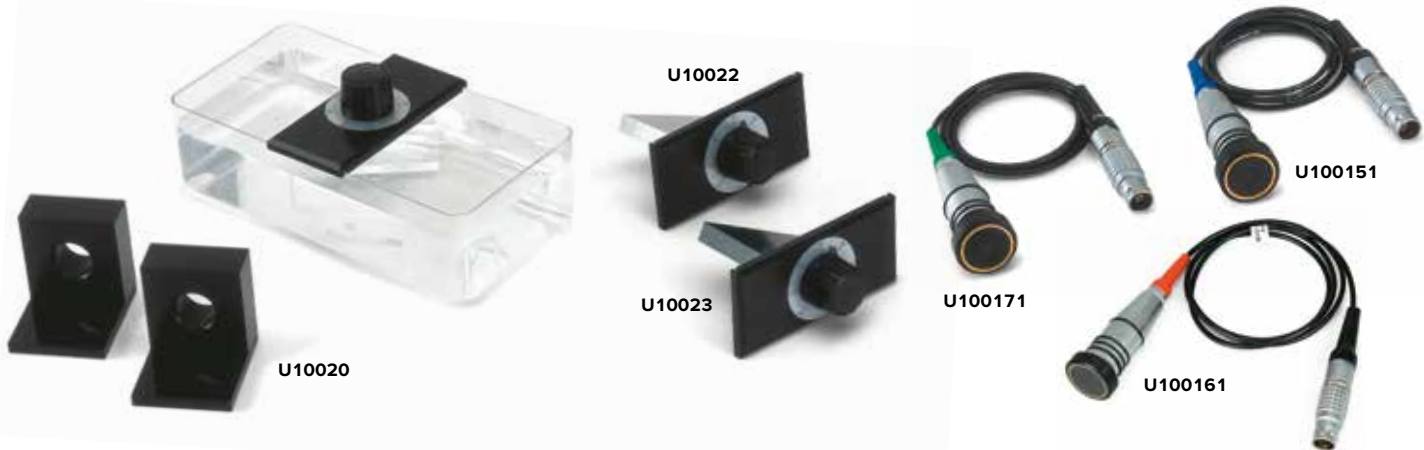

Ultrasonic Probe 1 MHz, GS200

Ultrasonic probe for tests involving large penetration depths or high acoustic power at low depth resolutions. It includes a 16-mm piezo-ceramic disc in a die-cast metal case and a 1-m long cable with a frequency-coded snap-in plug. The equipment is adapted to sound in water/acrylic glass.

Dimensions: 65 mm x 27 mm diam.
For use with ultrasonic echoscope GS200

U100151

Ultrasonic Probe 4 MHz, GS 200

Ultrasonic probe for investigations with small penetration depths and maximum depth resolution. It includes a 16-mm piezo-ceramic disc in a die-cast metal case and a 1 m long cable with a frequency-coded snap-in plug. The equipment is adapted to sound in water/acrylic glass.

Dimensions: 65 mm x 27 mm diam.
For use with ultrasonic echoscope GS200

U100171

Pair of Reflection Blocks with Delay Line

These polished polyacrylate blocks are used to investigate multiple echoes and measure frequency-dependent attenuation. A 4 MHz probe (U100171) is especially suitable for such measurements. An echo pattern comprising at least 3 echoes is recorded, and the spectra of the individual echoes analysed. The result of the analysis is a shift in the average frequency toward lower frequencies, due to a stronger attenuation of the signal's high-frequency components.

Dimensions: 80x40x10 mm³

U100251



U100251

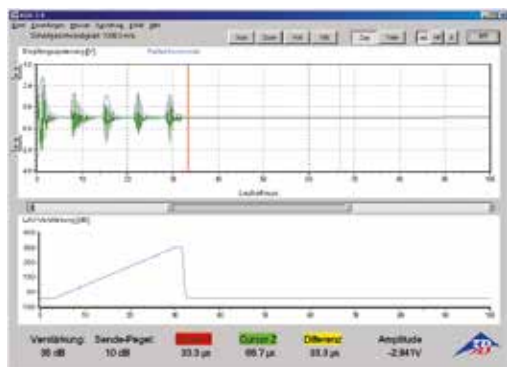

Multiple reflections from a mirror plate

Ultrasonic Probe 2 MHz, GS200

Ultrasonic probe for investigations at medium penetration levels and depth resolution. It includes a 16-mm piezo-ceramic disc in a die-cast metal case, adapted to sound in water/acrylic glass, a 1 m long cable with a frequency-coded snap-in plug.

Dimensions: 65 mm x 27 mm diam.
For use with ultrasonic echoscope GS200

U100161

Equipment Set "Ultrasound in Solids"

Equipment kit for the investigation of the propagation of longitudinal and transversal waves (shear waves) as well as for the determination of elastic constants (shear modulus, elasticity modulus and Poisson's ratio) in solid bodies. Further for the determination of ultrasonic attenuation in liquids by means of time dependent amplitude measurement with sliding reflector (U10022). Consisting of acoustic basin, polyacrylic test plate in holder with protractor scale and two probe holders to accommodate and precisely position two 1 MHz (U100151), 2 MHz (U100161) or 4 MHz (U100171) ultrasonic probes on the acoustic basin.

Sound trough: 200x100x60 mm³
Test plate: 104x75x50mm³
Protractor scale: 360°, 5° divisions
Polyacrylate block: 70x45x10 mm³

U10020

Additionally recommended:

- U10022 Aluminium Test Block with Protractor Scale**
- U10023 Polyoxymethylene Test Block with Protractor Scale**

Aluminium Test Block with Protractor Scale

This accessory to equipment set U10020 for longitudinal and transverse waves is used to examine the propagation of transverse waves in metals and ascertain the elastic constants of aluminium, such as its shear modulus, modulus of elasticity and Poisson ratio. The test block's very high reflectivity with high reflection coefficient in water provides sizeable signal amplitudes for measurements of attenuation in liquids (e.g. water, cooking oil or glycerine).

Protractor scale: 360°, 5° divisions
Aluminium block: 70x45x10 mm³
Dimensions: 104x75x50 mm³

U10022

Polyoxymethylene Test Block with Protractor Scale

This accessory to equipment set U10020 for longitudinal and transverse waves is used to examine the propagation of transverse waves in plastic and ascertain the elastic constants of polyoxymethylene (POM) such as its shear modulus, modulus of elasticity and Poisson ratio.

Protractor scale: 360°, 5° divisions
POM block: 70x45x10 mm³
Dimensions: 104x75x50 mm³

U10023

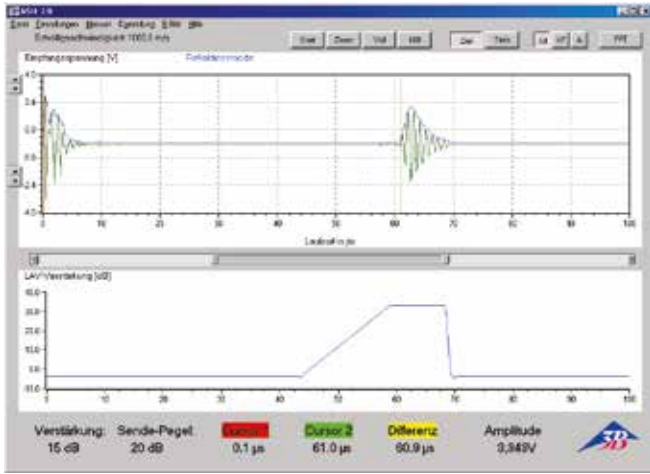

Pulse echo signal from a hole



U10027

Ultrasound

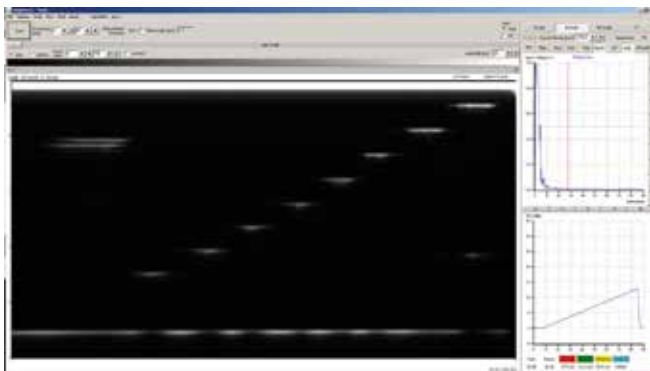

B-image: acrylic body with drilled holes

Acrylic Body with Drilled Holes

Polished polyacrylic block with bores of various diameters and varying distance from the surface to determine the speed of sound and the attenuation of ultrasonic signals in polyacrylate, to localise defects, investigate aberrations resulting from acoustic shadows and ground returns, analyse frequency-dependent resolving power and display manual B-images.

Dimensions: 150x80x40 mm³

U10027

Additionally required:

- U100102 Ultrasonic Echoscope GS200**
- U100151 Ultrasonic Probe 1 MHz, GS200**
- U100171 Ultrasonic Probe 4 MHz, GS200**
- XP999 Ultrasonic Coupling Gel**

Heart Model

This double vessel with a rubber membrane and pressure regulator is used to demonstrate movement of the cardiac wall by means of the time-motion technique. In the experiment the membrane vessel produces images similar to the cardiac wall of a beating heart during echocardiography in medical diagnostics.

Dimensions: 160x70 mm²

U10029

- Additionally required:
- U100102 Ultrasonic Echoscope GS200**
 - U100171 Ultrasonic Probe 4 MHz, GS200**
 - XP999 Ultrasonic Coupling Gel**



U10029



U10026

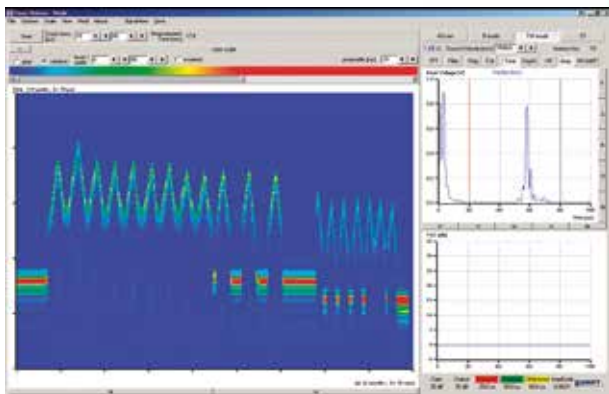

Time motion scan

Set of 3 Cylinders

These polished polyacrylate cylinders are used to ascertain the speed of sound and the attenuation of ultrasonic waves in transparent acrylic. Measurements can be performed in reflection mode or through-transmission mode.

Length : 40 mm, 80 mm and 120 mm
Diameter: 40 mm

U10026

Waves and Sound

Model Eye for Ultrasonic Biometry

Model of the human eye, enlarged to a scale of 3 to 1, including the cornea, the lens and glass bodies for demonstrating the fundamentals of ultrasonic biometry. The biometric ratios in the human eye (distance between cornea and lens, thickness of lens, distance between lens and retina) are very well suited to demonstrating measurement using a pulse-echo method with ultrasound. With the help of an ultrasonic echoscope GS200 (U100102) and a 2-MHz ultrasonic probe (U100161), typical echoes and the speed of sound can be measured. This allows the geometry of individual objects in the eye to be calculated. A lesion close to the back of the eye becomes apparent due to the diffuse nature of its echo.

Diameter: 80 mm

U10018



U10018

Additionally required:

- U100102 Ultrasonic Echoscope GS200**
- U100161 Ultrasonic Probe 2 MHz, GS200**
- XP999 Ultrasonic Coupling Gel**

Recommended for comparison:

F15 Model of the Human Eye, 3 times full-size, 6 part

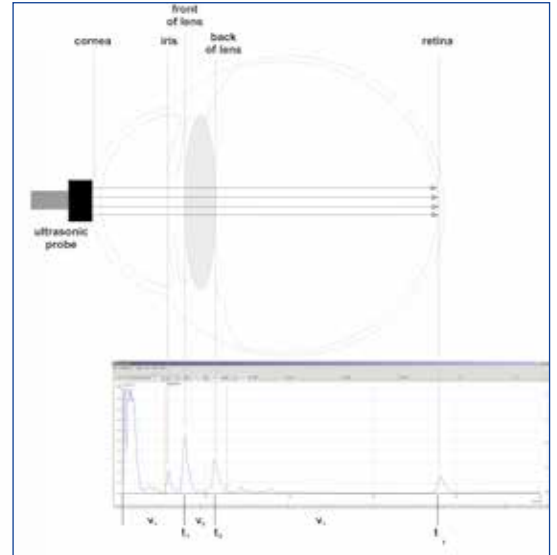

A-mode image and schematic diagram of the human eye

Single Breast Model with Benign Tumour

Model of a woman's breast made of 3B SKINlike™ silicone with simulated benign tumour for the demonstration of ultrasonic B-image mode.

L55/1

Additionally required:

- U100102 Ultrasonic Echoscope GS200**
- U100151 Ultrasonic Probe 1 MHz, GS200**
- XP999 Ultrasonic Coupling Gel**

Ultrasonic Coupling Gel (not shown)

To secure the ultrasonic probes to solid test objects.

Contents: 250 ml

XP999

Doppler Phantom Fluid

Phantom fluid with excellent scattering characteristics for ultrasonic waves in the frequency range from 1 – 6 MHz and viscosity calibrated for ultrasonic Doppler experiments. In plastic bottle.

Contents: 1 l
 Ultrasonic scattering: 1 – 6 MHz
 Colour: blue
 Diameter of glass microspheres: 30 – 50 µm

U10004



U10004

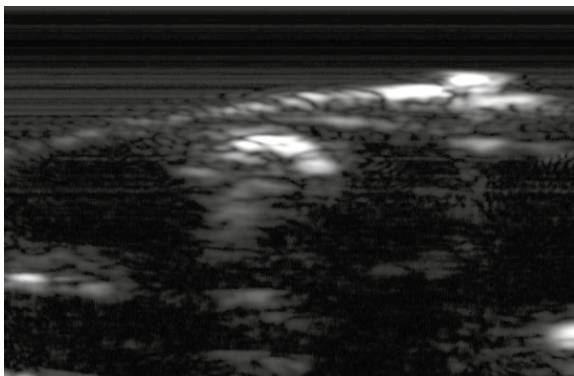

B-image: breast model

Equipment:

- U10001 Ultrasonic Doppler Apparatus**
- U10016 Ultrasonic Probe 2 MHz**
- U10002 Set of Doppler Prisms and Flow Tubes**
- U10003 Riser Tubes for Pressure Measurement**
- U10004 Doppler Phantom Fluid**
- U10005 Centrifugal Pump**
- XP999 Ultrasonic Coupling Gel**

Ultrasonic Doppler Apparatus

Ultrasonic device for carrying out experiments on the Doppler principle, on fluid mechanics and on Doppler sonography in the diagnosis of vascular problems. Includes measurement and evaluation software for Windows operating systems in order to display the measured signals and colour-coded Doppler spectra. If the radiated waves are reflected or scattered from moving particles or bubbles in fluid flow, the Doppler shift in frequency can be detected. The equipment detects the scattered waves and generates an audio signal at a volume that reflects the amplitude of the reflected signal and a frequency that reflects the speed of the scattering. At the same time, the amplitude is also displayed on an LED bar display. Sensitivity and volume can be adjusted by means of appropriate controls. The controller can also pass on data to a PC for detailed recording and evaluation. During measurement the current LF Doppler signal is displayed. Evaluation is by means of a Fourier transformation in the frequency domain and the result can be interpreted as the distribution of velocity within the flow.

- Frequency: 1 MHz, 2 MHz and 4 MHz
- Gain: 10 – 40 dB
- Display: LED bar display and acoustic signal with volume control
- PC connector: USB
- Mains voltage: 90 – 230 V, 50/60 Hz
- Dimensions: approx. 256x185x160 mm³

U10001

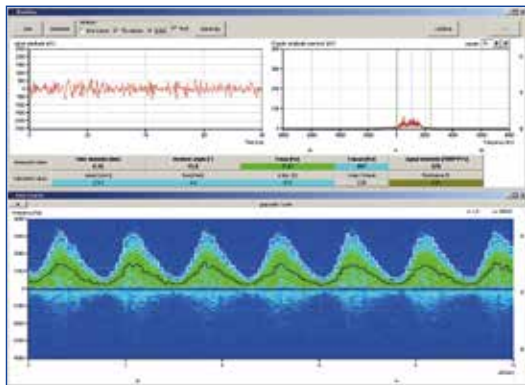

Centrifugal Pump

Pump for transporting liquids at a constant flow velocity which can be regulated continuously to any value and intended for the investigation of flow phenomena with laminar flow profiles. The pump has 3/8" plug-in connectors for insertion into a flow circuit (U10002) or an arm simulator (U10019). The display can be switched to show either speed or flow. The display of the flow can be calibrated to match the flow pressure. For Doppler sonographic experiments using a so-called arm phantom to simulate a real arm, the pump can be set to provide a pulsing flow (to simulate a heart beat) with a variable pulse frequency. This allows ultrasonic signals to be obtained which are typical for vascular diagnosis.

- Connectors: 2x 3/8"
- Max. flow: 6 l/min
- Display: LCD
- Mains voltage: 90 – 230 V, 50/60 HZ

U10005

Experiment Topics:

- Investigation of flowing liquids using ultrasonic waves
- Experiments on the Doppler principle
- Measurement of flow velocities
- Demonstration of laminar and turbulent flow
- Experiments on the continuity equation, Bernoulli's equation (static and dynamic pressure) and the Hagen-Poiseuille law (resistance to flow)

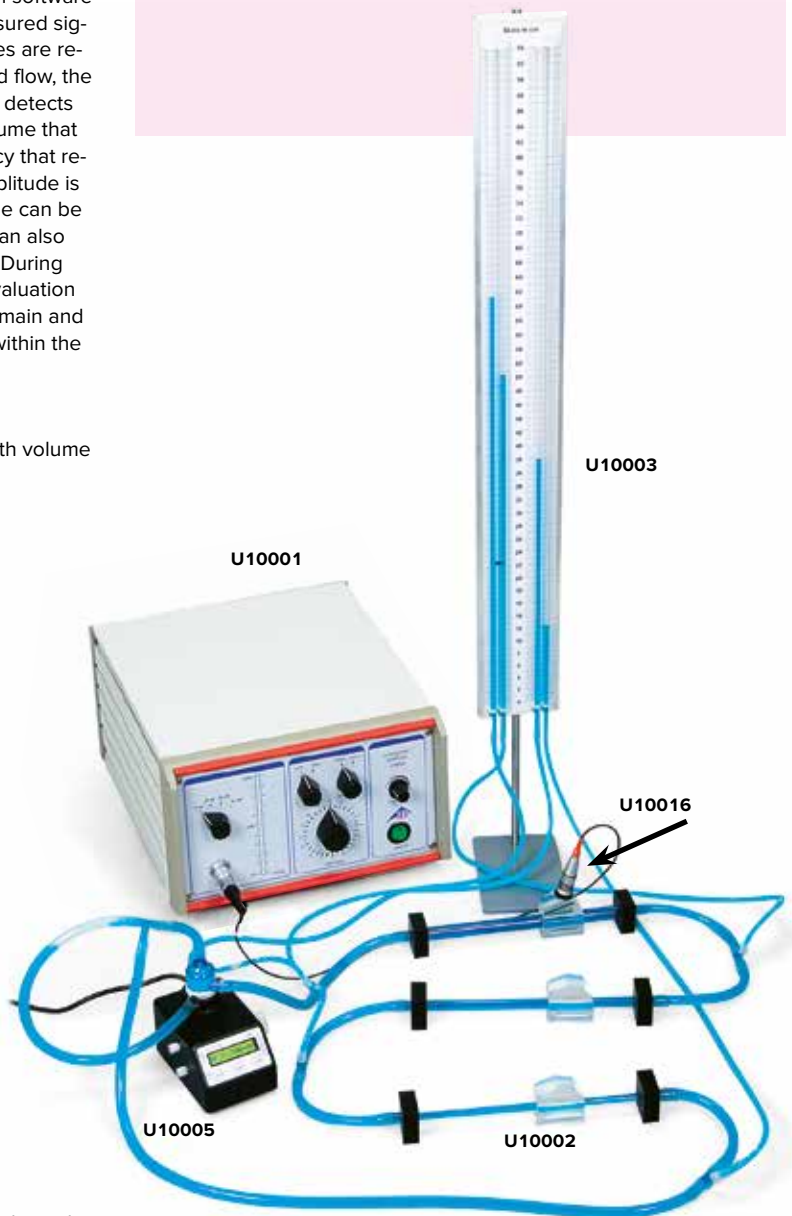

Set of Doppler Prisms and Flow Tubes

Equipment set including plastic tubes and hoses of various diameters for investigating flow phenomena using ultrasonic waves. Includes Doppler prisms for connecting an ultrasonic probe to the tubes or hoses at three different angles.

Contents:

- 1 Doppler prism 1/4"
- 1 Doppler prism 3/8"
- 1 Doppler prism 1/2"
- 1 Flow tube 1/4", 300 mm
- 1 Flow tube 3/8", 300 mm
- 1 Flow tube 1/2", 300 mm
- 1 Hose 1/4", 1000 mm
- 1 Hose 3/8", 3000 mm
- 1 Hose 1/2", 1000 mm
- Various hose connectors, T-pieces and accessories

U10002



Riser Tubes for Pressure Measurement

Set of four riser tubes with millimetre scales for measuring the relationship between pressures at up to four measuring locations in a flow circuit. Includes tubing and Luer-Lock connectors for attachment to a flow circuit and stand.

- Length: 1000 mm
- Connectors: Luer Lock, male
- Length of tubing: 1200 mm
- Tubing connector: 3/8" female Luer Lock connector

U10003



Ultrasonic Probe, 2 MHz

Ultrasonic probe for investigations at medium penetration levels and depth resolution. It includes a 16-mm piezo-ceramic disc in a die-cast metal case, adapted to sound in water/acrylic, a 1-m long cable with a frequency-coded snap-in plug.

Dimensions: 65 mm x 27 mm dia.
For use with Ultrasonic Doppler Apparatus

U10016



Arm Phantom Set

Model of a human arm for simulating Doppler sonographic examinations of blood vessels. Includes an ultrasonic Doppler probe and so-called phantom fluid for simulating blood. The model features a variety of tubing (simulating blood vessels), including one tube which simulates a blood vessel stricture or stenosis. Using the ultrasonic Doppler apparatus (U10001) and a centrifugal pump (U10005), it is possible to simulate typical examinations used in vascular diagnosis. Doppler spectra are measured for the flow through arteries and veins with both a pulsing flow (like a heart beat) and continuous flow, allowing sounds typical of Doppler sonography to be heard. One particularly interesting feature is the possibility of observing the change in the spectra and the Doppler sound due a stenosis (stricture) in the elbow. In addition, it is possible to calculate the flow index and resistance index from the curves measured with a pulsing flow.

Probe frequency: 2 MHz
Probe dimensions: 200 mm x 15 mm diam.
Length of lead: 1 m

Includes:

- Model arm with stenosis
- Silicone tubing
- 3/8" connectors
- Ultrasonic Doppler probe
- Phantom fluid to simulate blood, 250 ml
- Funnel
- Rubber stoppers

U10019

Equipment:

- U10001 Ultrasonic Doppler Apparatus**
- U10005 Centrifugal Pump**
- U10019 Arm Phantom Set**
- XP999 Ultrasonic Coupling Gel**

Experiment Topics:

- Doppler sonographic examinations of the human arm
- Measurement of the flow velocity of blood
- Recording of Doppler spectra and pulse curves
- Diagnosis of stenosis (vascular stricture) in an arm

U10019

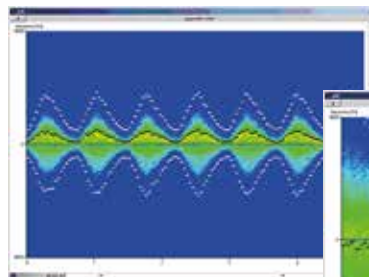

Doppler spectrum of arterial blood flow

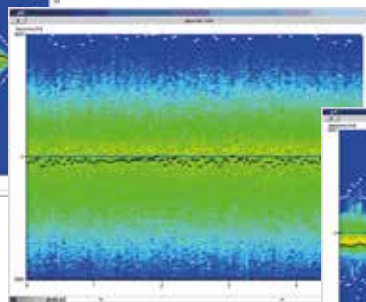

Doppler spectrum of a stenosis (stricture)

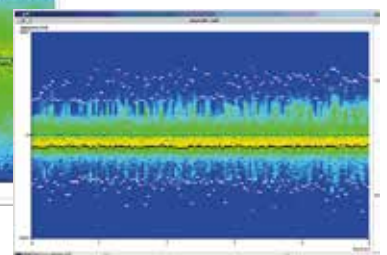

Doppler spectrum of blood flow in veins

Ultrasonic Computer Tomography

In order to control computer tomography by means of a computer, the AScan software supplied with the ultrasonic echoscope is used. It can generate mechanically scanned so-called B scans as well as ultrasonic tomographic images. The CT algorithm is incorporated into the AScan software in the form of a module. Both unfiltered and filtered attenuation and run-time scans, the current A scan, the configuration of the run-time dependent gain and the amplitude of the row scan currently being undertaken are all depicted graphically. In addition, the various scanner positions in millimetres and the current angle of rotation in degrees are displayed. The CT scan (attenuation and run-time scans) is updated after each row is scanned and enhanced step by step so that the emergence of the tomographic image can be understood in its individual stages. The CT and B scans can be exported and printed out. Depending on the time and the object being studied, the number of angular positions and the step range can be specified along with the length of the scan.

Equipment Ultrasonic Computer Tomography

Quantity/Description	Art.-Nr.
1 Ultrasonic echoscope GS200	U100102
1 CT scanner	U10630
1 CT controller	U10631
1 measuring trough	U10633
1 CT sample	U10632
2 Ultrasonic probes 1 MHz, GS200	U100151
1 Ultrasonic probe 2 MHz, GS200	U100161



U10630

CT Controller

Controller for operating the two stepper motors for the linear motion axis and the rotation axis of the CT scanner. Control of motion or direction of rotation, as well as linear speed and rotational velocity can be set manually or with a PC via a USB connection.



U10631

Output: 2 x Stepper motor controllers, bipolar, 5 V, max. 2 A
 Port: USB
 Supply voltage: 100 – 240 V, 50/60 Hz
 Power consumption: max. 50 VA
 Dimensions: 155x170x315 mm³

U10631

CT Scanner

CT scanner for turning and moving samples for the purpose of generating tomographic images. All turning and movement is carried out by means of stepper motors. While the measurement is taking place, the scanner moves the sample backwards and forwards between the ultrasonic sensors connected to the outside of the sample container in accordance with the CT algorithm. Includes a sample stage for making recordings of suitable objects for observation. The sample stage is immersed in a sample trough. The whole slider is height adjustable so that it is possible for the area of the sample under investigation to be modified.

Linear movement: max. 400 mm
 Local resolution: <10 μm
 Maximum speed of movement: 18 cm/min
 Turning angle: 0 – 360°
 Angular resolution: 0.225°
 Maximum angular velocity: 1 rpm
 Dimensions: 210x353x520 mm³

U10630



U10633

CT Measuring Trough

Sample trough for CT scanner made of thin transparent plastic. Includes several special fittings for attaching and connecting ultrasonic sensors to the sides of the trough. Since transparent acrylic exhibits a very low acoustic impedance step response as compared to water, reflections are largely eliminated.

Material: Acrylic
 Thickness of sides: 4 mm approx.
 Dimensions: 430x150x150 mm³

U10633

CT-Sample

Black plastic cylinder with non-uniform absorption and speed of sound within its interior. With magnetic holder for attachment to the revolving stage of the CT scanner. In the case of ultrasonic tomography, two different measurement variables can be recorded, absorption and speed of sound.

Diameter: 60 mm
 Height: 70 mm

U10632



U10632

Tomorrow's Energy Carriers

Fuel cells, electrolyzers, solar hydrogen technology – significant contributors to a sustainable energy supply in the future: preservation of the environment and resources while maintaining today's standard of living. Now you can demonstrate the mode of operation of this fascinating technology to your students. Pure water is broken down by means of electrolysis into hydrogen and oxygen for the purpose of energy storage with the help of regenerative energy. During reconversion of the gases in a fuel cell, electricity, heat and water are formed. The resolute use of membrane technology in the training and demonstration systems does away with the use of corrosive liquids and only distilled water is required.

Fuel Cell Demonstration System

Model showing the function of a hydrogen solar cell consisting of: • Solar module; • PEM electrolyser; • Hydrogen and oxygen accumulators; • PEM fuel cell; • Fan

Conveniently arranged on a baseplate.

Solar module: 2.0 V / 350 mA

Electrolyser: 1 W

Fan output: 10 mW

Dimensions: approx. 100x300x150 mm³

Weight: approx. 600 g

U109501

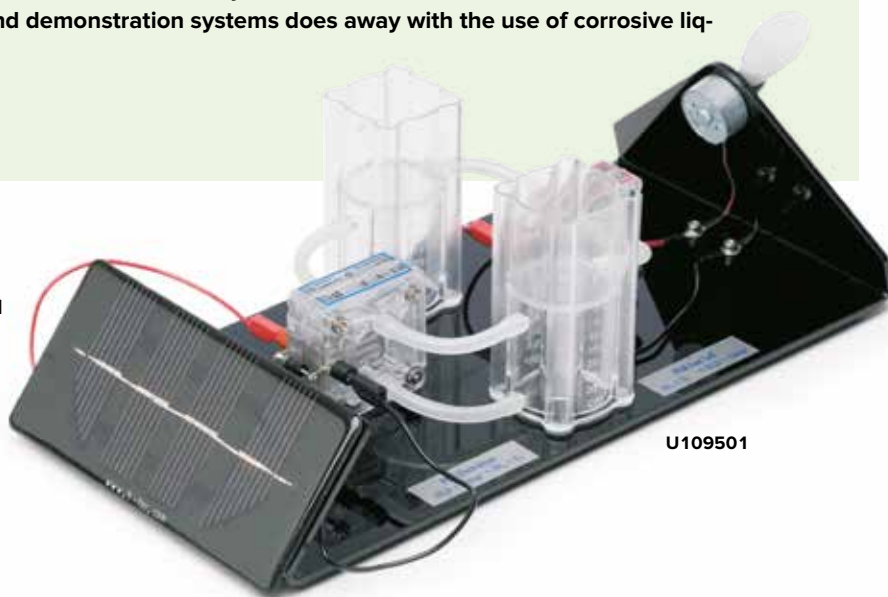

For your safety:

Exclusive use of distilled water.

No corrosive electrolytes such as potassium hydroxide (KOH).

Halogen Lamp 500 W (230 V, 50/60 Hz)

Strong light source for experiments, e.g. for use with solar energy basic kit (U8461200). With handle.

U8476713-230

Additionally required:

U13270 Stand Base

Spare Bulbs for Halogen Lamp – 500 W (230 V, 50/60 Hz)

U8476714-230

Solar Energy Basic Kit

Set of equipment including four test bodies with different surface coating, heat insulators and covers for experiments on the utilisation of solar energy. Four series of measurements that can be completed in approximately 25 minutes elucidate the temperature characteristics and peaks of the test bodies when exposed to sunlight. The kit comes in a robust storage case.

Storage capacity: approx. 365x310x70 mm³

Weight: approx. 1 kg

Contents:

- 4 Solar measuring bodies, each of a different colour
- 2 Insulating housings
- 2 Mounts for the measuring bodies
- 1 Transparent acrylic plate
- 4 Thermometers, -10 – +110° C

U8461200

Additionally required:

U8476713-230 Halogen Lamp, 500 W (230 V, 50/60 Hz)



U8476713-230



U8461200



U8461300

Bolometer

Designed to measure heat radiation from the sun, this device consists of an aluminium tube with a blackened front enclosed in a cardboard tube blackened on the inside. Includes a borehole for a thermometer.

- Aluminium tube: 30 x 40 mm diam. approx.
- Cardboard tube: 195 x 50 mm diam. approx.
- Weight: 350 g approx.

U8461300

- Additionally required:
- U8451700 Thermometer, +10 – +30° C**
 - U13261 Universal Clamp**
 - Stand Equipment**



U8441301

Moll-Type Thermopile

Sensitive probe for measuring heat radiated by a black body or Leslie's cube, as well as for detecting visible light and ultra-violet radiation. Comprises a metal housing with a polished, conical reflector and a black surface 15 mm in diameter with 17 linked thermocouples. With two 4 mm connectors mounted on a stem.

- Sensitivity: approx. 0.28 mV/μW
- Internal resistance: approx. 1 Ω
- Setting duration: 40 s (95%)
- Tripod: 156 x 10 mm diam.
- Dimensions: 94 x 40 mm diam.
- Weight: approx. 200 g

U8441301

- Additionally required:
- U8557380 Analogue Multimeter ESCOLA 100**
 - U8611210 Barrel Foot**
 - 2 Experiment leads**

Greenhouse Effect Kit

A set of equipment permitting quick and easy experiments to demonstrate the effect of greenhouse gases on the absorption of infra-red radiation. Solar radiation received by the earth is simulated here by means of short-wave infra-red radiation that is attenuated by absorption in water and visible light from a reflector lamp. Infra-red radiation emitted by the earth is simulated by heating a black metal disc. Both types of radiation are made to pass through air or butane gas in a metal tube and subsequently registered with a thermopile. Comparison of the obtained values reveals that long-wave infra-red radiation is absorbed to a high degree by butane gas. Consequently butane gas released into the atmosphere causes it to heat up, i.e. butane gas is a greenhouse gas.

Contents:

- | | |
|-----------------------------------|-------------------------|
| 1 Base plate | 1 Metal tube, simple |
| 1 Lamp holder with reflector lamp | 1 Metal tube, with taps |
| 1 Cuvette on stem | 2 Mounting stems |
| 1 Black metal disc | 1 Silicone hose |
| | 1 Storage case |

Greenhouse Effect Kit (230 V, 50/60 Hz)

U8460500-230

Greenhouse Effect Kit (115 V, 50/60 Hz)

U8460500-115

- Additionally required:
- U8441301 Moll-Type Thermopile**
 - Butane (lighter gas)**
 - U8532161 Measuring Amplifier S**
 - U8475470-230 Transformer 12 V (230 V, 50/60 Hz)** or
 - U8475470-115 Transformer 12 V (115 V, 50/60 Hz)**
 - U8557380 Analogue Multimeter ESCOLA 100**
 - Alternative:
 - U8531401-230 Measuring Amplifier (230 V, 50/60 Hz)** or
 - U8531401-115 Measuring Amplifier (115 V, 50/60 Hz)**
 - U11806 Digital Multimeter P1035**

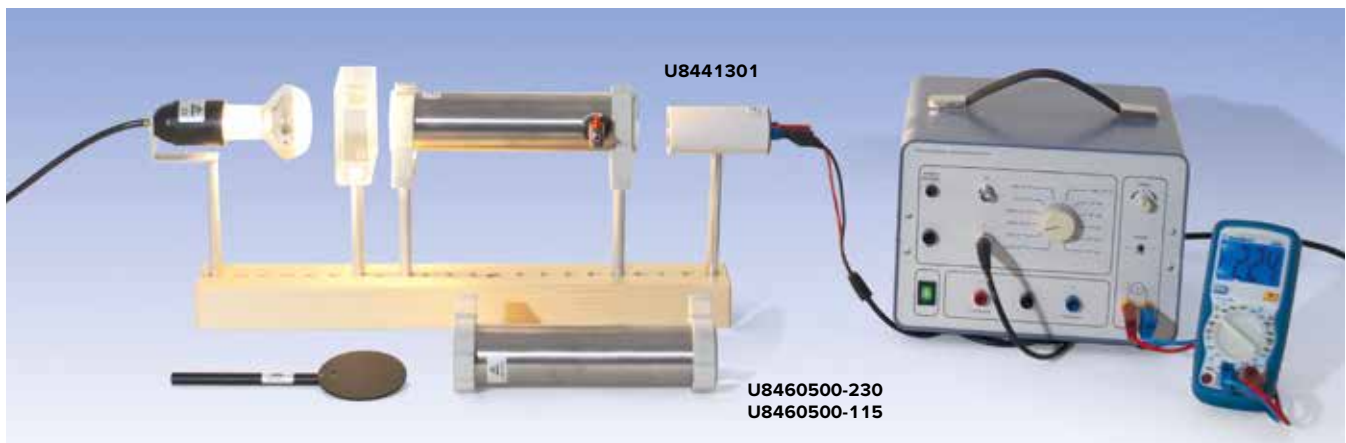

U8441301

U8460500-230
U8460500-115



U14293

Precision Hair Hygrometer

Hygrometer for measuring the relative air humidity, consisting of a round plastic housing with a synthetic hair as the measuring element. The specially treated hair exhibits an almost inertia free response to changes in humidity. Wall mountable.

- Measuring range: 0% – 100% relative humidity
- Temperature range: -35° C – +65° C
- Reading accuracy: ± 5%
- Diameter: 100 mm

U14293

U16102



Digital Hygro-Thermometer

Digital measuring device for displaying exterior and interior temperature and humidity. With min/max function and acoustic signal if exterior temperature drops to or below zero, switchable between °C and °F, on/off button, eyelet for hanging up and fold-out stand.

- Measuring range:
- Temperature (interior): 0° C – +50° C / 32° F – +122° F
- Temperature (exterior): -50° C – +70° C / -58° F – +158° F
- Humidity: 20% – 99%
- Divisions: 0.1° C/F, 1%
- Accuracy (temp.): ±1° C / ±2° F
- Accuracy (humidity): ±3%
- Exterior temperature sensor: Cable length 3 m

U16102

U11819



Infra-red Temperature and Humidity Gauge

Digital measuring device for contact-free temperature measurement from large distances, e.g. of hot or moving objects or inaccessible points of measurement, and for simultaneous humidity display. With laser diode as detection aid, integrated in the measuring probe, illuminated LCD display, max and data-hold function, switchable between °C and °F, automatic switch-off. Includes pouch and battery.

- Measuring range, temperature: -50° C – +500° C; -58° F – +932° F
- Divisions: 0.1° C/F
- Accuracy: ±2% of measured value ±2° C / 4° F
- Measuring range, humidity: 5% – 95%
- Divisions: 0.1%
- Accuracy: ±3.5%
- LCD dual-function display: 3½-digit, 21 mm with backlighting
- Voltage supply: 9 V battery
- Dimensions: approx. 90x170x45 mm³
- Mass: approx. 360 g

U11819

Demonstration Aneroid Barometer

Barometer for measuring air pressure and demonstrating how an aneroid barometer operates. The measurement system consists of two flat, highly-evacuated metal cans which deform in response to changes in the air pressure. This deformation is indicated by a pointer. The pointer mechanism and metal cans are situated behind a glass cover for easy observation. By pumping the attached rubber ball the action caused by the air pressure changes can be demonstrated.

- Measuring ranges: 955 – 1070 mbar, scale division 1 mbar
- 715 – 800 mmHg, scale division 1 mmHg
- Scale diameter: 120 mm
- Housing diameter: 130 mm
- Weight: 650 g

U10260



U10260

Maximum-Minimum Thermometer

Reading of maximum, minimum and instantaneous temperature. In plastic housing with reset button and hanging strap. Red alcohol filling.

- Measuring range: -43° C – +50° C
- Divisions: 1° C
- Dimensions: approx. 230x85 mm²

U29563

U29563



Digital Pocket Anemometer

Waterproof anemometer for measuring wind speed. Indication of wind chill temperature based on the combination of air temperature and wind speed. Indication of mean and maximum speeds. Wind curves on the Beaufort scale. Supplied with closeable cover.

Wind speed: 0.2 – 30 m/s
 Accuracy: $\pm 5\%$ of mean wind speed
 Units: km/h, m/h, m/s or knots
 Temperature: -30° – $+59^{\circ}$ C
 Battery: 3.0 V (CR2032)
 Dimensions: 137x50x18 mm³

W13623



W13623

Aneroid Barometer F

Aneroid Barometer in a metallic box with altitude adjustment screw at the rear. Graduations in mm of mercury and hPa. Diameter of the dial: 98 mm

U29948



U29948

Wireless Weather Station

Weather station with wireless detection of external temperatures from up to three sensors situated at distances of up to 25 m. Display of internal temperature and humidity. Features switchable $^{\circ}$ C/ $^{\circ}$ F display, min/max function, weather forecasting, trend displays for air pressure and radio-controlled clock with date function. Supplied with one external temperature sensor, two 1.5-V AA batteries and two 1.5-V AAA batteries. Silver/grey housing. Can be suspended or set up on a surface.

External temperatures: -30° C – $+70^{\circ}$ C
 Internal temperatures: 0° C – $+60^{\circ}$ C
 Humidity: 1 – 99%

W13620



W13620

Noise: the World's no. 1 Pollutant

Noise

- Damages hearing
- Makes it more difficult to hear genuinely important signals
- Impedes both physical and mental work
- Disturbs and adversely affects well being
- Disturbs relaxation and sleep
- Can cause chronic stress, physical ailments and illness



U10610

Noise Level Indicator SPL

Handy and easy-to-use noise level meter with digital display in decibels (dB) and an arbitrarily adjustable trigger threshold for use as a traffic-light style noise indicator with a happy green face and a sad red face. Can be mounted on a wall or set up on a table top. Its well-conceived compact design makes it easy to transport. Automatically switches to electricity-saving stand-by mode when noise is low for a long period. The brightness of the display can also be adjusted. Includes a stand base, USB/miniUSB cable, USB power supply and transport case.

Display: 100 mm diam, with LED
 Measuring range: 40 dB – 130 dB
 Resolution: 1 dB
 Thresholds for colour display: Adjustable to any level in steps of 1 dB
 Power supply: 5 V DC via miniUSB socket
 Power consumption: 150 mA (normal operating mode)
 <1 mA (stand-by)
 USB power supply: 100 – 240 V, 50/60 Hz
 Dimensions: 130x145x12 mm³
 Weight: 400 g approx.

U10610





Thermometer Clip
Stainless steel clip for holding thermometers in beakers.

U8452570.....



U8451700

U14297

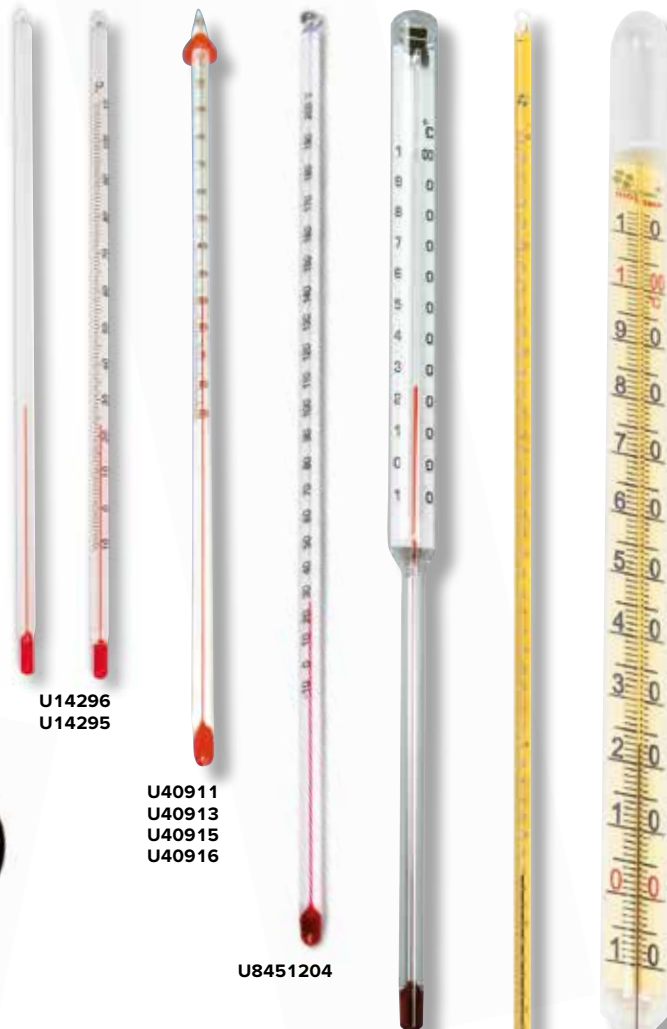

U14296
U14295

U40911
U40913
U40915
U40916

U8451204

U8451310



U11331

U11330

Temperature Sensor, Pt100

Temperature sensor for the measurement of temperatures in organic liquids, solutions of salts, acids, and bases. The stem and tip of the temperature sensor are of stainless steel. Can be used in conjunction with 3B NET/og™ unit (U11300-230 or U11300-115) for manual measurements or for processing measurement data when connected to a computer. Includes connector lead with 8 pin miniDIN plugs.

Measurement range: -50°C – 150°C
Resolution: 0.1° C
Accuracy: 0.1% of measured value plus 0.25°C
Sensor cable: 1 m, with silicone insulation
Sensor type: Pt100 thermocouple

U11330.....

Temperature Sensor, TC – K

Temperature sensor for the measurement of extremely low and extremely high temperatures, for example in liquid nitrogen or liquid oxygen, or inside a flame. With room temperature compensation. The immersible NiCr-Ni sensors (U11854 and U11855) can also be connected to the sensor box. Can be used in conjunction with a 3B NET/og™ unit (U11300-230 or U11300-115) for manual measurements or for processing measurement data when connected to a computer. Includes connector lead with 8 pin miniDIN plugs.

Measurement range: -270°C to 400°C
Accuracy: 0.2% plus 3°C (-270°C – 0°C)
0.1% plus 2°C (0°C – 400°C)
Resolution: 1°C
Sensor type: NiCr-Ni (type K)
Sensor length: 60 cm approx.

U11331.....



U11854

U11855

U16115

U16120

K-Type NiCr-Ni Immersion Sensor, -65° C to 550° C

Temperature measurement sensor with stainless steel (V4A)-tube, spring-mounted (rigid) and silicone cable.

Measuring range: -65° C – 550° C
Response time: approx. 3 s
Tube: 130 mm x 1.5 mm diam.

U11854.....

K-Type NiCr-Ni Immersion Sensor, -200° C to 1150° C

Sheath thermocouple with stainless steel (Inconel) tube, flexible and silicone cable.

Measuring range: -200° C – 1150° C
Response time: approx. 3 s
Tube: 150 mm x 1.5 mm diam.

U11855.....

Art. No.	Scale division	Measuring range	Scale division	Dimensions	Remarks
U8451700	Thermometer	+10° – 30°C	0.2°C	140 mm x 6 mm diam.	Tube type, white coated capillary, red alcohol filling.
U14297	Pocket Thermometer	-10° – 110° C	1° C	165 mm x 10 mm diam.	Tube type, scale on white background, special red filling, in yellow plastic protective case with clip.
U14295	Tube Thermometer, graduated	-10° – 110° C	1° C	260 mm x 6 mm diam.	Glass thermometer with eyelet, scale on white background, special red filling, in transparent square plastic case.
U14296	Tube Thermometer, not graduated	–	–	260 mm x 6 mm diam.	For demonstrating function and mode of operation of thermometers. Like U14295 but without scale.
U40911	Thermometer	-20° – 110° C	1° C	295 mm x 6.3 mm diam.	Tube type with anti-roll design, white coated capillary, red alcohol filling, packed in a plastic tube.
U40913	Thermometer	-10° – 150° C	1° C	295 mm x 6.3 mm diam.	Tube type with anti-roll design, white coated capillary, red alcohol filling, packed in a plastic tube.
U40915	Thermometer	-20° – 110° C / 0° – 230° F	1° C/F	295 mm x 6.3 mm diam.	Tube type with anti-roll design, white coated capillary, red alcohol filling, packed in a plastic tube.
U40916	Thermometer	-20° – 150° C / 0° – 300° F	1° C/F	295 mm x 6.3 mm diam.	Tube type with anti-roll design, white coated capillary, red alcohol filling, packed in a plastic tube.
U8451204	Thermometer	-10° – 200° C	1° C	300 mm x 6 mm diam.	Rod-shaped general-purpose thermometer, white-coated capillary, red indicator liquid, total immersion depth.
U8451310	Rod Thermometer	-10° – 100° C	1° C	350 mm x 8 mm diam., Length of rod: 150 mm	Rod thermometer with internal scale made of frosted glass, prismatic capillary tube and red liquid.
U16115	Stable Tube Type Thermometer	-1° – 101° C	0.2° C	460 mm x 7 mm diam.	Stable tube type thermometer with biodegradable special blue filling, scale on yellow background, with eyelet.
U16120	Demonstration Thermometer	-10° – 110° C	1° C	650 mm x 30 mm diam.	Extra-large tube type thermometer with biodegradable special blue filling, easy-to-read scale on yellow background.

Digital Quick-Response Pocket Thermometer

For instantaneous measurements on surfaces, in liquids, soft plastic media, air/gases, very small objects. For connection to a K-type NiCr-Ni measurement sensor. Sensor not included in scope of supply.

Measuring range: -65° C – 1150° C / -85° F – 1999° F in 2 ranges

Division: 0.1° C / 1° C/F

Accuracy in

lowest range: 0.05% of measured value ±0,2% FS

Display: 3½-digit LCD display, 13 mm in height

Dimensions: 106x67x30 mm³

Mass: approx. 135 g

U11853

Additionally required:

U11854 K-Type NiCr-Ni Immersion Sensor, -65° C to 550° C

or

U11855 K-Type NiCr-Ni Immersion Sensor, -200° C to 1150° C

U11853





U29627

Insertion Thermometer F

Waterproof digital thermometer with a 125 mm long sensor to measure the temperature of liquid, pulverulent and soft substances. With memory function, min/max function, reversible °C/°F. Plastic casing, clip and LR 44 button battery included.

Measuring range: -40 – +200°C
 Accuracy: ±0.8 degree (from 0 – 100°C),
 ±1 degree (from -20 – 0°C),
 ±1.5 degree (others)

Measurement interval: 1 s
 Dimensions: 205x20x17 mm³
 Mass: 56 g

U29627

Insertion Thermometer

For measuring the temperature in air, liquids and soft materials. Temperature sensor made of stainless steel with protective case, switchable between °C and °F, On/Off switch and automatic switch-off.

Measuring range: -50° C – 150° C / - 58° F – 302° F
 Division: 0.1° C/F
 Accuracy: ±1° C / ±2° F
 Temperature sensor: 130 mm x 4 mm diam.
 Mass: 29 g

U40170



U40170

Digital Thermometer, Min/Max

Insertion thermometer with Hold and Min/Max function in robust plastic housing and temperature sensor made of stainless steel. Switchable between °C and °F, On/Off switch, hanging strap and folding angled support.

Measuring range: -50° C – 200° C / -58° F – 392° F
 Division: 0.1° C/F
 Dimensions: 95x65x20 mm³
 Cable length: 1400 mm
 Measurement probe: 120 mm

U16101



U16101

Digital Pocket Thermometer

Temperature sensor made of stainless steel with protective case, watertight, switchable between °C and °F, Min/Max/Hold function, automatic switch-off.

Measuring range: -40° C – 200° C / -40° F – 392° F
 Division: 0.1° C/F
 Accuracy: ±1° C / ±2° F
 Dimensions: 150x20x18 mm³
 Mass: 20 g

U40173



U40173

Infra-red Thermometer

Surface thermometer for contactless temperature measurement from a safe distance, e.g. in inaccessible places, hot or moving objects. With laser diode for laser sighting, illuminated LCD display, range overflow display, measured value storage function, selection between Celsius and Fahrenheit, automatic switch off. Includes bag and battery.

	U118152	U118161
Designation	Infra-red Thermometer, 800° C	Infra-red Thermometer, 380° C
Measuring range	-50° C – +800° C -58° F – +1472° F	-50° C – 380° C -58° F – 716° F
Division	0.1° C/F	1° C/F
Accuracy	±1% of measured value ±1° C / 1.8° F	2% of measured value +2° C / 4° F
Response time	150 ms	< 1 s
Optical resolution	20:1	12:1
Max. temperature display	yes	–
Alarm function	high/low	–
Voltage supply	9 V battery	9 V battery
Dimensions	146x43x104 mm ³	160x82x45 mm ³
Mass	approx. 170 g	approx. 180 g

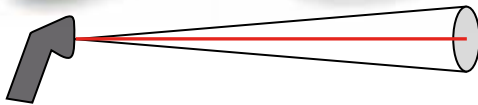

	U11817	U11818
Designation	Digital Thermometer, 1 Channel	Digital Thermometer, 2 Channels
Measuring range	-50° C – +1300° C -58° F – +2000° F 223 K – 2000 K	-50° C – +1300° C -58° F – +2000° F
Division	0.1° C/F, 1 K	0.1° C/F
Accuracy	±0.5% +1° C / +2° F ±1% +2 K	±0.5% +1° C / +2° F
Display	3½-digit illuminated LCD	3½-digit illuminated LCD
Digit size	21 mm	21 mm
Voltage supply	9 V battery	9 V battery
Dimensions	approx. 90x170x45 mm ³	approx. 90x170x45 mm ³
Mass	approx. 350 g	approx. 350 g



U11823

Thermometers

Digital Thermometer Type K/IR

Digital two channel thermometer with two K-type inputs and additional external infra-red sensor. Can also be used for measurements at low temperatures. With automatic shut off, maximum value storage and data hold function. Includes case, 2 K-type thermocouple sensors, infra-red temperature sensor, 9 V battery and instruction manual.

- Measurement inputs: 2x K-type, external IR input
- Measuring functions: T1, T2, T3, T1-T2, T1-T3, T2-T3
- Measuring range: -200 – 1372°C (type K), -30 – 550°C (IR)
- Measurement error: ±0.5% + 2°C (type K), ±2.5% + 2°C (IR)
- Resolution: 0.1°C
- Unit of measurement: °C or K
- Emission factor: 0.95 fixed
- Digital display: 3½ digit LCD
- Background lighting: blue
- Operating voltage: 9 V battery
- Dimensions: 75x200x50 mm³ approx.
- Mass: 280 g approx.

U11823.....

Digital Thermometer

Versatile digital thermometer for type-K temperature sensors with single or dual input (U11818) for measuring instantaneous or differential temperature T1 – T2 (U11818). With storage of maxima and Data-Hold function. Includes type-K temperature sensor (U11818 2x), battery, holster and carrying bag.



U11817 / U11818

Heat and Thermodynamics

Heat Equivalent Apparatus

Apparatus for determining the specific heat capacity of aluminium and for confirming the energy conservation law. The robust heat equivalent apparatus consists of a shaft with ball bearings at both ends, an integrated counter for measuring the number of revolutions performed and an attached table clamp for securing the device. The aluminium calorimeter body heats up as a result of frictional work or electrical energy from the integrated heating element. An NTC thermistor, acting as a temperature sensor and located in an aluminium case, determines the temperature. The calculation can be performed easily using the temperature calibration table printed on the apparatus.

- Length: 230 mm
- Span of the table clamp: 10 – 65 mm span
- Cord length: approx. 1.80 m
- Calorimeter body: 50 mmx48 mm diam.
- Electric heater power: 10 V, 1 A
- Weight calorimeter: 250 g
- Total mass : approx. 1200 g

Contents:

- 1 Basic unit
- 1 Aluminum calorimeter
- 1 Temperature sensor
- 1 Pair of adaptor cables with 4 mm safety plugs/2 mm plugs
- 1 Friction belt
- 1 Bucket, 5 l
- 1 Counterweight

U10365

Additionally required for temperature measurement:

U11806 Digital Multimeter

Additionally recommended:

U33020-230 DC Power Supply, 0 – 20 V, 0 – 5 A (230 V, 50/60 Hz)

or

U33020-115 DC Power Supply, 0 – 20 V, 0 – 5 A (115 V, 50/60 Hz)

U10366 Copper Calorimeter

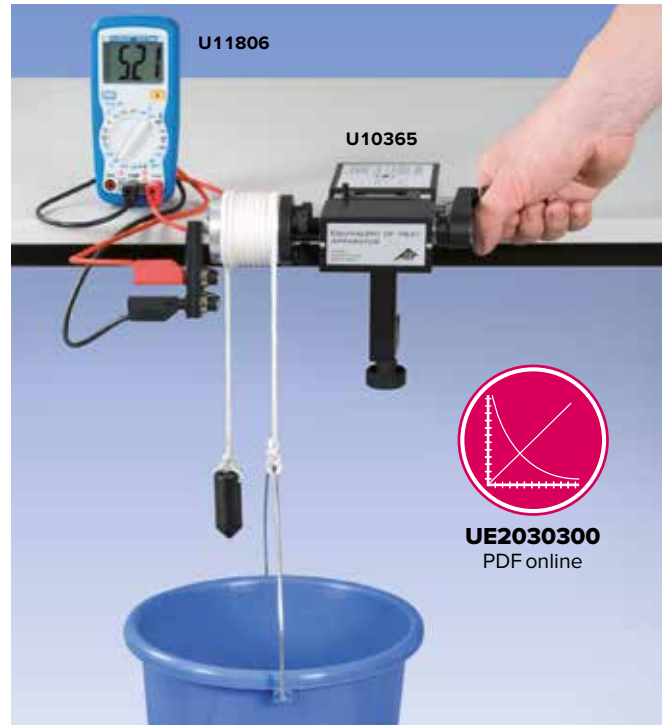

UE2030300
PDF online

Calorimeter Bodies

Calorimeter bodies for the heat equivalent device and for determining the specific heat capacity. With borehole for holding temperature sensor and with integrated heating element.

- Electric heater power: 10 V, 1 A
- Heating element connection: via 2-mm sockets
- Dimensions: approx. 50 mm x 48 mm dia.
- Weight: approx. 750 g (Cu) / 250 g (Al)

Copper Calorimeter

U10366

Aluminium Calorimeter

U10367

Temperature Sensor

Temperature sensor (NTC thermistor) for use with calorimeter bodies (U10366 and U10367).

U10368

Pair of Adapter Cables with 4 mm Safety Plugs/2 mm Plugs

Cables for connection to contacts of heating elements in calorimeter bodies (U10366 and U10367).

U10369



UE2030400
PDF online

Calorimeter, 200 ml

For determining temperatures of mixtures, specific heat capacities, conversion energies of substances and heat of fusion of ice. Designed for simple experiments for students. Plastic container with styrofoam inlay.

- Capacity of insulated container: approx. 200 ml
- Weight: approx. 80 g

U8441050

Additionally required:

U8451310 Tube Thermometer, -10 – +100° C

Additionally recommended:

U8442610 Aluminium Shot, 100 g

U8442620 Copper Shot, 200 g

U8442640 Glass Shot, 100 g



U8441050



Calorimeter with Heating Coil, 150 ml

For determining the specific heat capacity of solids and liquids and for measuring the electric heat equivalent. Two mutually insulated aluminum beakers, lid with rubber stopper with boreholes for thermometer and stirrer, with heating coil.

Capacity of insulated container: 150 ml
 Connection sockets: 4 mm
 Electric heater: 6 V/2 A max.

U8441020

Additionally required:
U14295 Tube Thermometer, -10 – +110°C

Additionally recommended:
U8442610 Aluminium Shot, 100 g
U8442620 Copper Shot, 200 g
U8442640 Glass Shot, 100 g
U33020-230 DC Power Supply, 0 – 20 V, 0 – 5 A (230 V, 50/60 Hz)
 or
U33020-115 DC Power Supply, 0 – 20 V, 0 – 5 A (115 V, 50/60 Hz)

Immersion Heater, 12 V

Sheathed heater suitable for the metal block calorimeters (from U30070).

Operating voltage: max. 12 V
 Power: max. 50 W (nominal)
 Tubing: 150 mm long
 Heated section: 70 mm
 Electrical connection: 4 mm sockets

U30075

Set of 4 Calorimeter Cylinders

Four cylindrical metal calorimeter blocks, each of mass 1 kg, for determining the specific thermal capacities of aluminium, brass, copper and steel. Each calorimeter cylinder has two holes for inserting a heating element (U30075) and a thermometer or temperature sensor.

Hole for heating element: 12.5 mm diam.
 Hole for thermometer: 8 mm diam.

U30070

Additionally required:
U30075 Immersion Heater, 12V Thermometer or Temperature Sensor

Calorimeter with Heating Coil, 1,200 ml

Calorimeter for determining specific heat capacities, conversion energies of materials, mixing temperatures as well as measurement of electrical equivalents of heat. Consists of a double-walled, heat-insulating plastic container with an insulating vessel inside made of reflecting glass, with heating coil and stirrer. Also includes a lid with an opening for a thermometer and two 4 mm plugs for connecting the power supply for the heating coil. The calorimeter is equipped with a heating filament, electrically insulated to avoid decomposition of filament and terminals due to electrolytic processes.

Max. heater voltage: 25 V
 Max. heating power: approx. 160 W
 Contents of insulated container: approx. 1200 ml
 Dimensions: approx. 240 mm x 120 mm diam.
 Weight: approx. 0.8 kg

U8441010

Additionally required:
U8451310 Tube Thermometer, -10 – +100°C

Additionally recommended:
U8442610 Aluminium Shot, 100 g
U8442620 Copper Shot, 200 g
U8442640 Glass Shot, 100 g
U33020-230 DC Power Supply, 0 – 20 V, 0 – 5 A (230 V, 50/60 Hz)
 or
U33020-115 DC Power Supply, 0 – 20 V, 0 – 5 A (115 V, 50/60 Hz)



Additionally required:
U33020-230 DC Power Supply Unit 0 – 20 V, 0 – 5 A (230 V, 50/60 Hz)
 or
U33020-115 DC Power Supply Unit 0 – 20 V, 0 – 5 A (115 V, 50/60 Hz)

Art. No.	Material	Height	Dia-meter	Specific heat J/(kg*K)
U30071	Aluminium	84 mm	75 mm	896
U30072	Brass	84 mm	44 mm	377
U30073	Copper	85 mm	43 mm	385
U30074	Steel	92 mm	44 mm	452





Demonstrate the forces resulting from changes in length arising from heat or cold. These forces are sufficient to break a 10-mm iron bolt.

Tyndall's Bar Breaker
 U-shaped clamping set up with a metal rib and fastening screw for demonstrating the linear expansion of metals on heating, as well as the tremendous forces which can be exerted in the process. The set includes 10 cast-iron bolts for breaking in the course of the experiment.
 Diameter for bolt hole: approx. 11 mm
 Length of clamping fixture: approx. 285 mm
 Weight: approx. 1400 g

U8442150

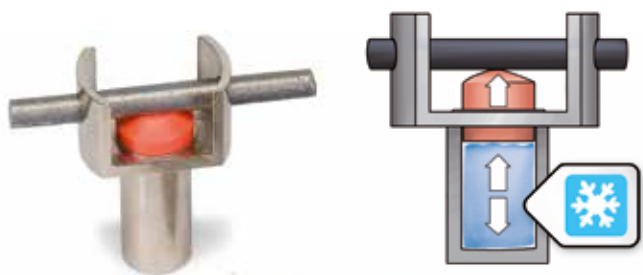

U8442120



U409001

Ball and Ring
 Brass ball and brass ring with plastic handles for demonstrating the thermal expansion of solid bodies. After heating in a burner flame, the ball no longer fits through the cold ring.
 Length: approx. 250 mm

U409001



Cast Iron Bolts, Set of 10 Bolts
 Spare bolts to be used with Tyndall's bar breaker (U8442150) or the ice bomb (U8442120).

U8442110

U8442110

Ice Bomb
 Clamping set up for demonstrating volumetric expansion of water on freezing, as well as the tremendous forces which can be exerted in the process. Comprises a steel cylinder with a clamping rib and plastic lid. The set includes 10 cast-iron bolts for breaking in the course of the experiment.

Diameter for bolt hole: approx. 11 mm
 Dimensions: approx. 40x30x75 mm³
 Weight: approx. 620 g

U8442120

Ball with Ring
 An arrangement for demonstrating the expansion of solids on heating. After heating in a burner flame, the ball no longer fits through the bore in the bracket. Steel ball with chain and handle.

Dimensions of the bracket in mm: approx. 40x50x40 mm²
 Diameter of ball: approx. 22 mm
 Length of handle with shaft: approx. 225 mm
 Weight: approx. 175 g

U8442500



U8442500

Linear Expansion Apparatus with Three Pointers

Apparatus for measuring the linear expansion of different kinds of solids simultaneously. The set includes three sample tubes (brass, aluminium and glass) which are heated by passing steam through them. Linear expansion is indicated on a mirror scale by three differently coloured pointers mounted on rollers. Includes silicone tubing. Dimensions of the tubes: 700 mm x 6 mm diam. Dimensions: approx. 830x80x70 mm³ Weight: approx. 1.2 kg

U8442200

Additionally required:
U8624650-230 Steam Generator (230 V, 50/60 Hz)
 or
U8624650-115 Steam Generator (115 V, 50/60 Hz)

Steam Generator

Device for generation of steam, e.g. in experiments on thermal expansion. Aluminum vessel with cork lid and retainer on an adjustable hot plate with a thermal circuit breaker.

Hotplate: 90 mm diam.
 Power consumption: 550 W
 Vessel volume: 250 ml
 Dimensions: 170 mm x 180 mm diam.
 Hose connection: 6 mm diam.
 Total mass: approx. 1 kg

Steam Generator (230 V, 50/60 Hz)

U8624650-230

Steam Generator (115 V, 50/60 Hz)

U8624650-115

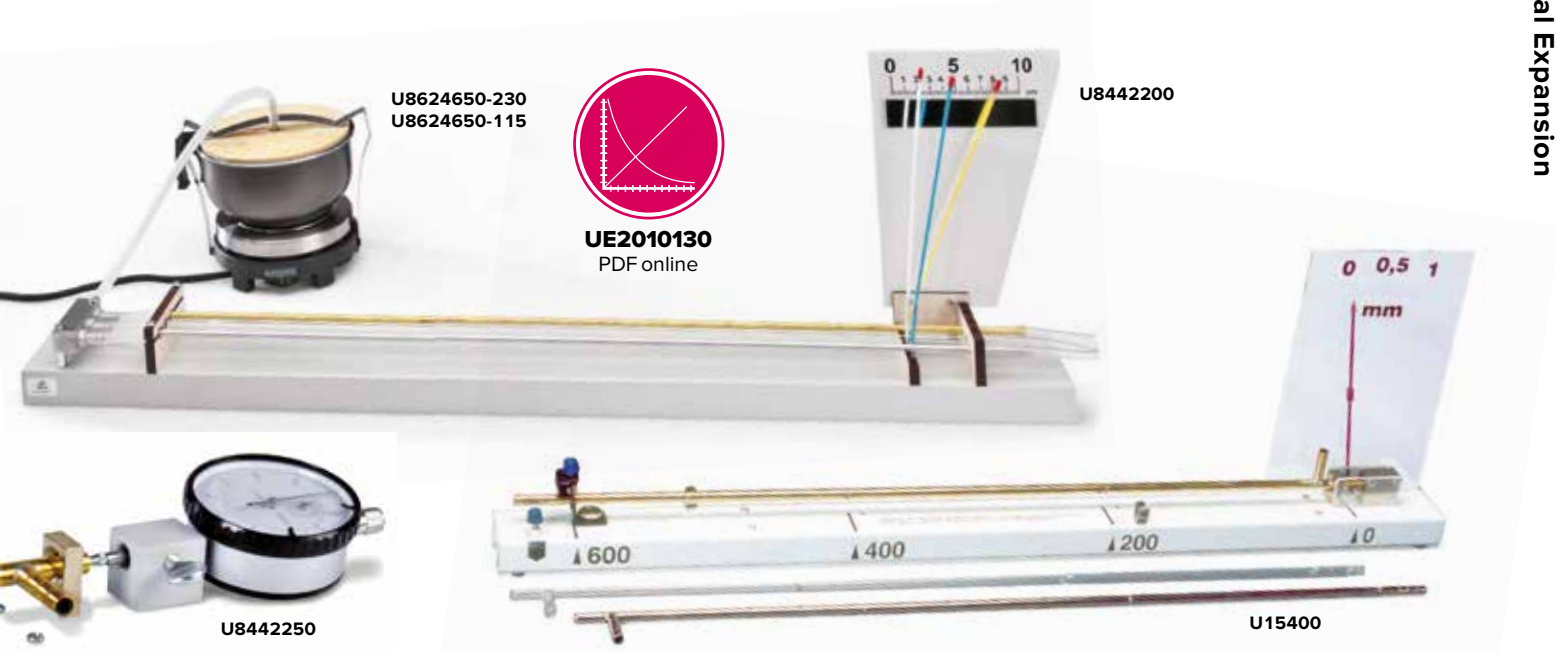

Gauge with Adapter

Analogue gauge for measuring minimal changes in length plus an adaptor for fitting a gauge dial as an enhancement to the extension apparatus D (U15400).

U8442250

Linear Expansion Apparatus S

A device for measuring the linear expansion of solids as a function of length and material. Includes three sample tubes (iron, copper and glass) which are heated by passing water vapour through them. Consists of a base strip with a clamping spring, pointer, scale and hose nipple.

Pointer ratio: 1:50
 Tube length: approx. 630 mm
 Dimensions: 530x60x240 mm³
 Weight: 0.6 kg

U15405

Additionally required:
U8624650-230 Steam Generator (230 V, 50/60 Hz)
 or
U8624650-115 Steam Generator (115 V, 50/60 Hz)
U10146 Silicone Tubing, 1 m

Linear Expansion Apparatus D

A device for measuring the linear expansion of solids as a function of length and material. Includes three sample tubes (steel, brass and glass) which are heated by passing water vapour through them. Consists of a base strip with a fixed bearing, pilot bearing, pointer and projectable scale.

Scale dimensions: 140x200 mm²
 Measuring range: 1 mm
 Reading accuracy: 0.05 mm
 Tube length: approx. 650 mm
 Dimensions: approx. 730x50x200 mm³
 Weight: approx. 2 kg

U15400

Additionally required:
U8624650-230 Steam Generator (230 V, 50/60 Hz)
 or
U8624650-115 Steam Generator (115 V, 50/60 Hz)
U10146 Silicone Tubing, 1 m

Additionally recommended:
U8442250 Gauge with Adapter

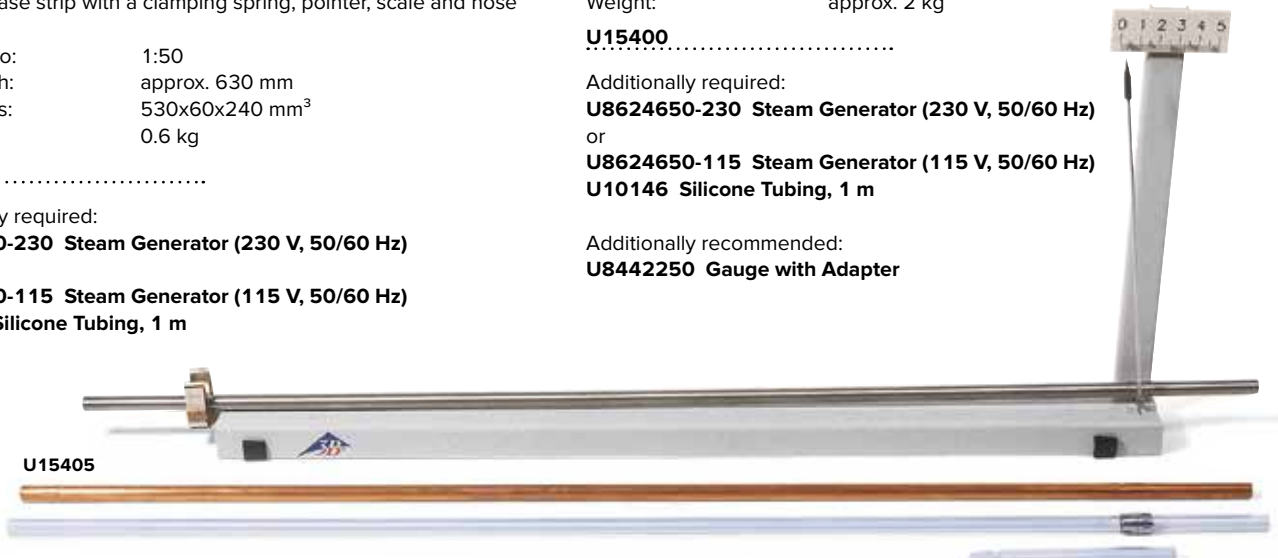

Experiment Topics:

- Thermal anomaly
- Density maximum

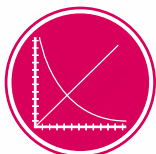

UE2010301
PDF online

U14318

U11854

T52006

U11817

U11876

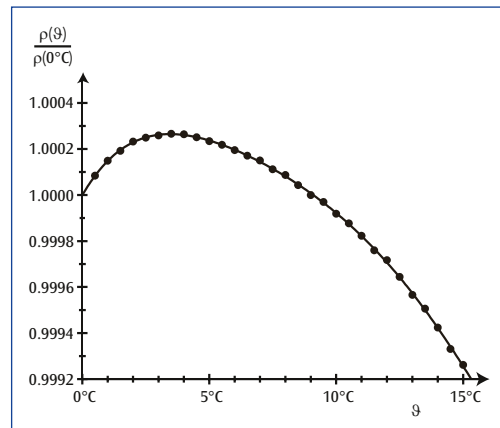

Determining the maximum density of water

Device for Demonstrating the Anomaly of Water

Apparatus for demonstrating the thermal anomaly of water, measuring its thermal expansion and determining its maximum density. Consists of a Duran glass vessel with an inlet tube and two GL screw connections for mounting the riser tube with a mm scale and a thermometer. Includes stirring rod.

- Volume: 250 ml
- Riser tube: 400 mm
- Capillary: 1.5 mm diam.
- Hose nipple: 8 mm
- Overall height: approx. 500 mm

U14318

Additionally required:

- T52006 Plastic Trough**
- U11876 Magnetic Stirrer**
- U16115 Tube Thermometer**
- or
- U11817 Digital Thermometer**
- and
- U11854 K-Type NiCr-Ni Immersion Sensor, -65°C – 550°C**

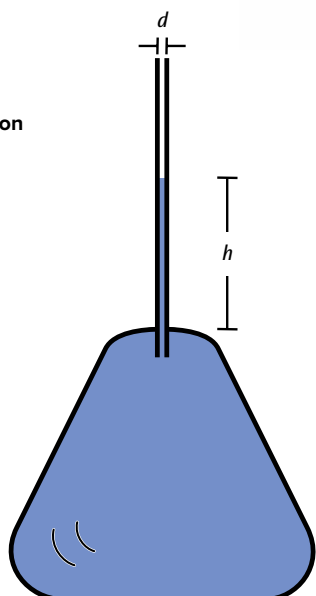

Vessel with riser tube



Gas Expansion Apparatus

Glass vessel with ground-glass sealing joints for demonstrating the expansion of air when heated. The U-tube is filled with water at room temperature and the water levels are marked. Even the heat from a hand is enough to cause the air in the flask to expand so that the water levels in the U-tube change visibly.

U58030

Volume Dilatometer

Glass vessel for investigating changes in volume in a liquid as a function of temperature and for determining volumetric expansion coefficients. With ground graduated riser tube.

- Volume: 50 ml
- Length of riser tube: 120 mm
- Scale: mm scale

U14225

Heat-Flow Device

Stable glass flask with rectangular bends for demonstrating the flow of heat in a liquid that is heated non-uniformly. With GL 18 screw fitting and side-limbs for filling with water, and a small quantity of potassium permanganate for colouring.

Dimensions: 420x420 mm²

Tube diameter: 30 mm

U14340

Additionally required:

U13271 Tripod Stand, 185 mm

U15002 Stainless Steel Rod, 470 mm

U13255 Universal Clamp

U13261 Universal Jaw Clamp

U8621240 Spirit Lamp

Potassium permanganate for use as a colouring agent

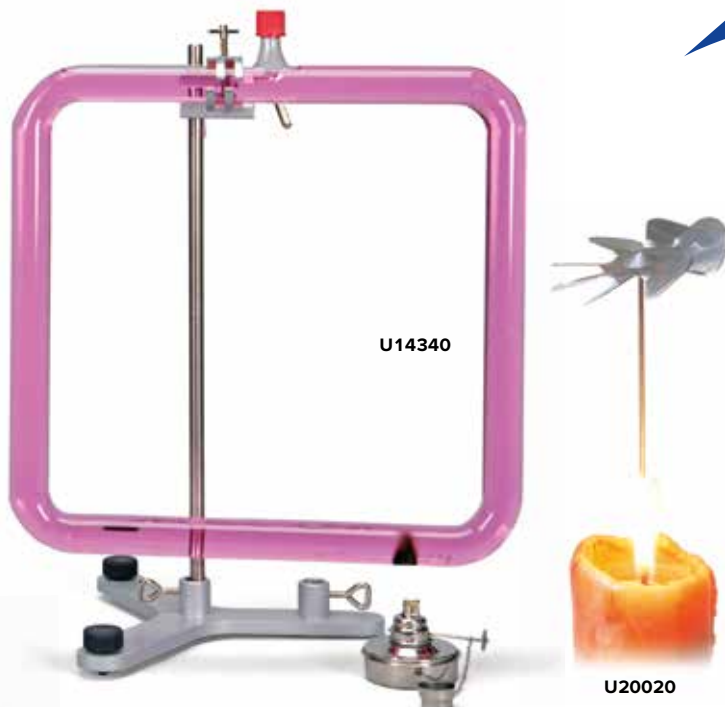

U14340

U20020

Heat Conduction / Heat Flow



U58031

Heat-Flow Device S

Stable glass flask on a stand for demonstrating the flow of heat in a non-uniformly heated liquid. With filling hole for filling with water and a small quantity of potassium permanganate crystals for colouring.

Glass flask: 300x150 mm²

Tube diameter: 14 mm

Height: 250 mm

U58031

Additionally required:

U8621240 Spirit Lamp

Potassium permanganate for use as a colouring agent

Vane Wheel

Device for demonstrating air and heat flows generated by a burning candle, water vapour or other heat sources. Made of Aluminium and mountable on a long needle.

U20020

Additionally required:

Long needle

Heat Conductivity Device

A device with five metal bars for comparing the thermal conductivity of aluminium, brass, steel, zinc and copper – by melting wax balls at the rod ends. The five rods extend in a star-shaped configuration from a brass hub. Each rod has a notch for holding wax.

Length: 340 mm

U409051



U409051

Thermal Conductivity Equipment Kit

Kit for the qualitative investigation of the heat conductivity of Aluminium (extremely high thermal conductivity) and expanded polystyrene (very low thermal conductivity). Even at room temperature the varying material temperatures are evident to the touch. In the experiment ice cubes are placed on the plates. The ice cube on the seemingly colder Aluminium plate melts much more quickly (in 1 – 2 minutes), while there seems to be no melting at all of the ice cube on the seemingly warmer plastic plate. Two rubber rings which prevent the ice cubes from slipping off the plates complete the experiment kit.

Plate dimensions: approx. 95x95x13 mm³

U45055

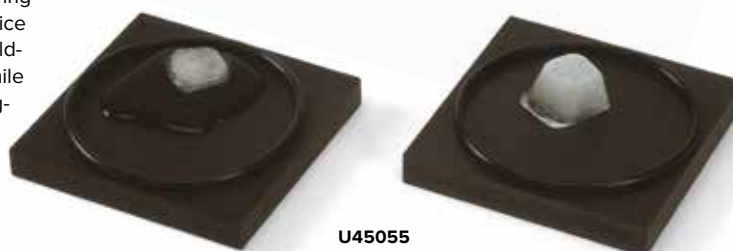

U45055

Heat and Thermodynamics



U8441301

Moll Type Thermopile

Sensitive probe for measuring heat radiated by a black body or Leslie's cube, as well as for detecting visible light and ultraviolet radiation. Comprises a metal housing with a polished, conical reflector and a black surface 15 mm in diameter with 17 linked thermocouples. With two 4 mm connectors mounted on a stem.
 Sensitivity: approx. 0.14 $\mu\text{V}/\mu\text{W}$
 Internal resistance: approx. 1 Ω
 Setting duration: 40 s for 95% of the measured value
 Rod: 156 mm x 10 mm diam.
 Dimensions: 94 mm x 40 mm diam.
 Weight: approx. 200 g

U8441301

Additionally required:
U8557380 Analogue Multimeter ESCOLA 100
U8611210 Barrel foot
2 Experiment leads

Equipment:
U8442835 Leslie's Cube
U8557350 Rotating base for Leslie cube
U8441301 Moll Type Thermopile
U118091 Digital Multimeter P3340
U11853 Digital Quick Response Pocket Thermometer
U11854 K-Type NiCr-Ni Immersion Sensor, -65°C – 550°C
U13812 Pair of Safety Experiment Leads, 75 cm
U11257 HF Patch Cord, BNC/4 mm Plug
U8611210 Barrel Foot, 500 g (2x)
U10073 Pocket Measuring Tape, 2 m
U8531401-230 Measurement Amplifier (230 V, 50/60 Hz)
 or
U8531401-115 Measurement Amplifier (115 V, 50/60 Hz)

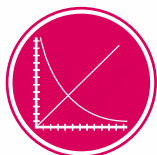

UE2020200
PDF online

Leslie's Cube

A hollow aluminium cube for investigating heat radiation from a hot body as a function of its temperature and surface. With a removable lid for pouring in hot water and 2 openings for inserting a thermometer or thermal sensor and a stirrer. One side each is polished, matte, black and white.
 Dimensions: 100x100x100 mm^3
 Weight: approx. 360 g



U8442835

U8442835

Additionally required:
U8441301 Moll Type Thermopile

Rotating Base for Leslie Cube

Plastic platform for Leslie Cube. With rotating bearing on stand rod. Includes felt strips for thermal insulation purposes.
 Dimensions: 100x100 mm
 Stand rod: 120 mm x 10 mm diam.



U8557350

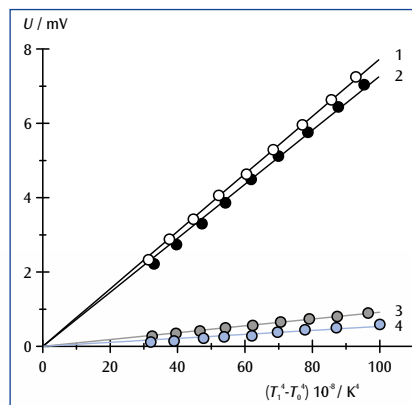

- 1: White surface
- 2: Black surface
- 3: Matte surface
- 4: Shiny surface

Radiated intensity from a Leslie Cube as a function of $x = T^4 - T_0^4$



Measure the heat radiated by a Leslie Cube

U8442835

Experiment Topics:

- Introduction to thermal radiation
- Stefan-Boltzmann law



U8498299-230
U8498299-115

Leslie Cube with Heater

Hollow cube made of aluminium for quantitative analysis of thermal radiation from a hot body as a function of temperature and the nature of the surface. Rotatable cube with built-in 150-W lamp and integrated temperature sensor for regulated heating of surfaces to a variable temperature. With holder for thermopile. One side each is plain, matt, white or painted black.

Heater power:	150 W
Max. temperature:	120°C
Resolution:	1°C
Display:	Two rows for actual and set-point temperatures
Dimensions:	250x250x220 mm ³ approx.
Weight:	1.8 kg approx.

Crookes Radiometer

Device for demonstrating the conversion of radiation energy into kinetic energy. Rotary-vane wheel mounted on a metal tip and equipped with four plates, each coloured black on one side; housed in an evacuated glass bulb.

Height:	210 mm
Ball diameter:	80 mm

U14300



U14300

Advantages

- Regulated electric heater with 150 W lamp
- Easy adjustment and display of actual and set-point temperatures
- No naked flame and no hot water required
- The cube can be turned, ensuring all surfaces are equidistant from the thermopile
- No additional stands needed

Leslie Cube with Heater (230 V, 50/60Hz)

U8498299-230

Leslie Cube with Heater (115 V, 50/60Hz)

U8498299-115

Additionally required:

U8441301 Moll Type Thermopile



U8490050



UE4050200
PDF online

Stefan-Boltzmann Lamp

High temperature source designed to produce thermal radiation, for investigating how such radiation depends on the temperature and to confirm the Stefan-Boltzmann law. The tungsten filament represents a good approximation of a point source of heat radiation and is thus highly suitable for investigating the inverse square law. The temperature of the lamp can be determined from the resistance of the filament. To minimise voltage loss, the lamp contacts are soldered to the connectors.

Nominal voltage:	12 V DC
Nominal current:	1.75 A
Nominal power:	21 W
Max. operating parameters:	13 V DC/2 A
Maximum temperature of filament:	3600 K

Contents:

- 1 Stand rod, 130 mm long
- 1 Stefan-Boltzmann lamp

U8490050

Additionally recommended:

U33020-230 DC Power Supply 20 V, 5 A (230 V, 50/60 Hz)

or

U33020-230 DC Power Supply 20 V, 5 A (115 V, 50/60 Hz)

U17120 Storage Rail

U8441301 Moll Type Thermopile

U118091 Digital Multimeter P3340 (3x)

Experiments on Heat Conduction and Electrical Conduction

Experiments on Heat Conduction and Electrical Conduction. Determination of electrical conductivity of copper and aluminium.

Quantity / Designation	Art. No.
1 Thermal conduction rod, Cu	U8498291
1 Thermal conduction rod, Al	U8498292
1 Microvoltmeter (230 V, 50/60 Hz)	U8530501-230
or	
1 Microvoltmeter (230 V, 50/60 Hz)	U8530501-115
1 DC power supply, 0 – 20 V, 0 – 5 A (230 V, 50/60 Hz)	U33020-230
or	
1 DC power supply, 0 – 20 V, 0 – 5 A (115 V, 50/60 Hz)	U33020-115
1 Digital Multimeter	U11806
1 Set of experiment leads, 75cm	U13801

Heat Conduction Equipment Set

Equipment set for investigating the heat conducting capabilities of metals in complete safety. The equipment set consists of an electronically regulated heat source for warming up a heat conducting rod, an insulating sleeve to reduce loss of heat to the surroundings and improve the linearity of the temperature profile, plus cooling baffles which can be used to radiate heat away from the apparatus. With a voltmeter and ammeter connected, it is possible to determine the electric power supplied to achieve the heating.

Maximum heating capacity: 43 W approx.

Maximum heat loss: 4.5 W

Temperature of heat source: 105°C

Operating voltage: 12 V DC

Maximum heating current: 3.6 A

Includes:

1 Heating module

1 Insulating sleeve

1 Cooling baffle (heat sink)

Heat conducting paste

U8498290

Additionally required:

U8498292 Heat conducting rod, aluminium

or

U8498291 Heat conducting rod, copper

U8498305 Table-top power supply

or

U33020-230 DC power supply, 0 – 20 V, 0 – 5 A (230 V, 50/60 Hz)

or

U33020-115 DC power supply, 0 – 20 V, 0 – 5 A (115 V, 50/60 Hz)



U8498305

Investigation of heat conduction in copper and aluminium in dynamic and static states

Quantity / Designation	Art. No.
1 Heat conducting rod, Cu	U8498291
1 Heat conducting rod, Al	U8498292
1 Heat conduction equipment set	U8498290
1 DC power supply, 0 – 20 V, 0 – 5 A (230 V, 50/60 Hz)	U33020-230
or	
1 DC power supply, 0 – 20 V, 0 – 5 A (115 V, 50/60 Hz)	U33020-115
2 Digital Multimeters	U11806
1 Digital thermometer, 2 channel	U11818
1 Set of experiment leads	U13801

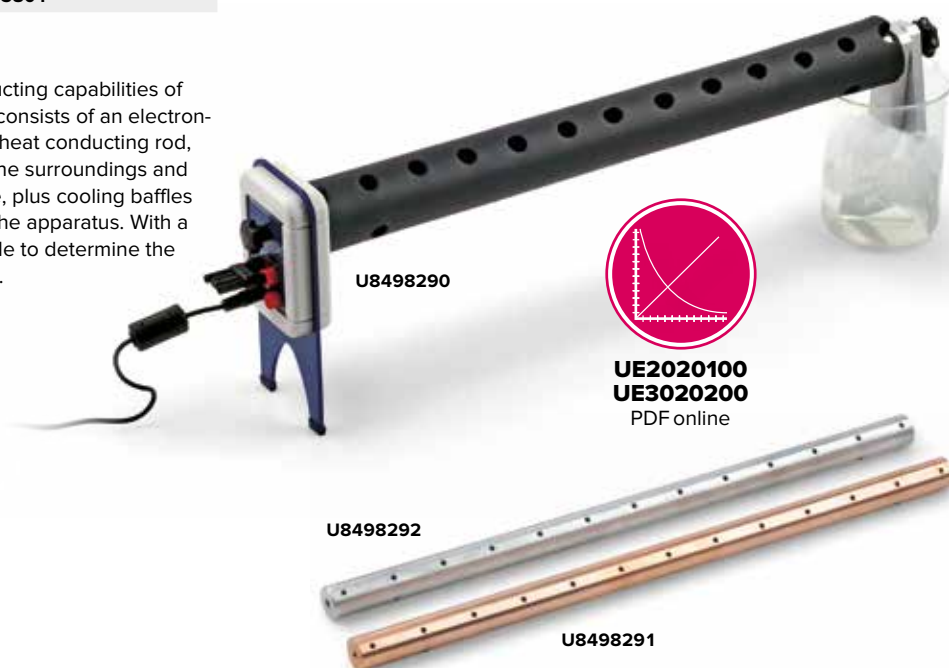

Heat Conducting Rods

Heat conducting rods for investigating heat conductivity in conjunction with the heat conduction equipment set or for investigating electrical conductivity with the help of four-wire measurement.

Length: 500 mm

Cross sectional area: 490 mm²

Measuring points: 13

Distance between

measuring points: 40 mm

Heat conductivity (Al): 236 Wm⁻¹K⁻¹

Heat conductivity (Cu): 240 – 380 Wm⁻¹K⁻¹

Heat Conducting Rod, Al

U8498292

Heat Conducting Rod, Cu

U8498291

Table-Top Power Supply

Table-top power supply for supply of power to the heat conduction equipment set.

Mains voltage: 100 – 240 V AC/1 A, 50/60 Hz

Output voltage: 12 V DC/4 A

U8498305

Experiment Topics:

- Thermal motion of atoms and molecules in various states of aggregation
- Electrical conduction processes
- Models of atomic physics
- Mechanical motion

Air-Cushion Plate

An ideal device for demonstrating a series of experimental models intended to study the motion of atomic particles:

- Objects hovering on the air cushion experience near-zero friction and are used to simulate particle motion. The set contains five different transparent, coloured plastic or aluminium elements with round ceramic magnets fitted to them to ensure elastic collisions.
- Magnetic barriers can be used to modify the plastic-bordered experimentation surface. This allows elastic collisions between the hovering bodies and the borders.
- A lattice model with a fixture is available for emulating crystal lattices in experiments on electrical conductivity in semiconductors, for instance. Comprises a height-adjustable acrylic plate from which 25 ceramic magnets are freely suspended.
- Two rod-shaped metal electrodes can be positioned in parallel with the experimentation surface in order to generate an electrical field. The effect of electrical fields on charged particles can also be simulated by inclining the experimentation surface.

The equipment system is characterised by a clear and simple design, minimum preparatory adjustment requirements, clear visibility of all experiments through overhead projection, simple operation and high reliability. The device consists of a robust frame with a pressure chamber whose cover plate is furnished with 1089 fine perforations and serves as an experimentation surface. Air is supplied to the pressure chamber by a blower via a hose, causing the coloured bodies to hover. An additional air stream from an impulse valve makes it possible to alter the motion of the hovering bodies. The air-cushion table is equipped with two adjustment screws. With two adjustable screws for horizontal alignment.

Dimensions: 350x350x75 mm³

Contents:

Air-cushion plate

Magnetic hovering bodies:

- Red, 16 mm diam. (30x)
- Green, 16 mm diam. (25x)
- Aluminium, 21 mm diam. (5x)
- Orange, 28 mm diam. (25x)
- Blue, 48 mm diam. (1x)

Magnetic barriers:

- 253 mm (2x)
- 233 mm (1x)
- 233 mm with a recess (1x)
- 233 mm with an opening, flat, with 4 magnets (1x)

Magnetic piston

Lattice model

Fixture for lattice model

Pair of electrodes

Plexiglass plate

Manipulation rod

Tweezers

Experiment manual

Wooden storage box

Tube

U15420

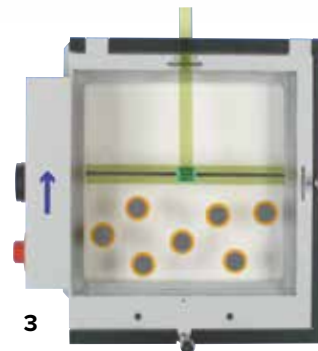
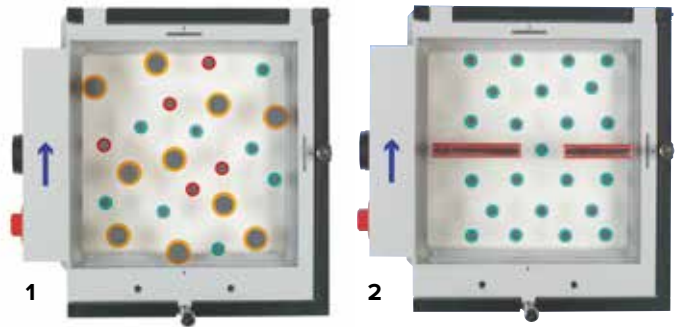

- 1: A mixture of gases
- 2: Penetration of gases through a porous membrane
- 3: Pressure as a function of temperature

Additionally required:

U15425-230 Air Flow Generator (230 V, 50/60 Hz)

or

U15425-115 Air Flow Generator (115 V, 50/60 Hz)

**Kinetic gas theory
made visible**



U15420

Qualitative Observations

- Liquid and gaseous states
- Dynamic compression and expansion
- Critical opalescence
- Formation of the transition point at various temperatures

Quantitative Measurements

- Display of the critical point and temperature
- Recording of isotherms in p-V (Clapeyron) diagrams
- Recording of isotherms in pV-p (Amegat) diagrams
- Pressure curves for a saturated vapour
- Differences between real gases and ideal gases

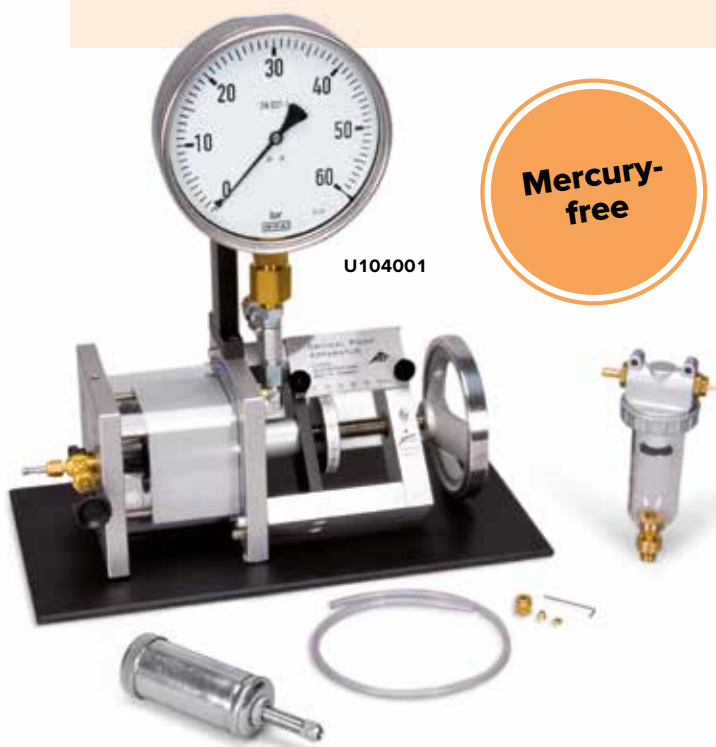

U104001

Mercury-free

Critical Point Apparatus

A high-precision apparatus for studying the compression and liquefaction of a gas, determining the critical point and recording isotherms in p-V (Clapeyron) diagrams. The test gas is sulphur hexafluoride (SF_6), which has a critical temperature of 318.6 K (45.5°C) and a critical pressure of 3.76 MPa (37.6 bars), allowing for a simple experiment set-up. The apparatus includes a transparent measuring cell that is highly resistant to leakage and compression. The volume inside the cell is changed via a finely adjustable handwheel, the change being indicated by a combination of a fixed and a rotary scale to an accuracy of $\frac{1}{1000}$ of the maximum volume. The pressure is generated by a hydraulic system containing castor oil of medically approved quality. The measuring cell and hydraulic system are separated by a cap seal which rolls in as the volume increases. This design means the pressure gradient between the measuring cell and oil chamber is negligible. A manometer measures gas pressure instead of oil pressure without taking up any dead space inside the measuring cell. During transitions from the gaseous to the liquid phases and vice versa, it is therefore possible to observe the formation of the first drops of liquid and disappearance of the last gas bubbles. The measuring cell is enclosed in a transparent water chamber. A circulation thermostat allows the temperature to be maintained at a highly constant value, which can be monitored by means of a thermometer. Practical indications of the volume, pressure and temperature permit easy recording of p-V or pV-p diagrams providing qualitatively correct results. Pres-

sure and temperature-dependent volumetric corrections also provide quantitatively accurate results comparing favourably with standard reference values.

Critical temperature:	318.6 K (45.5°C)
Critical pressure:	3.76 MPa (37.6 bars)
Critical volume:	197.4 cm ³ /mol
Critical density:	0.74 g/mol
Temperature range:	10 – 60°C
Maximum pressure:	6.0 MPa (60 bars)
Maximum volume:	15.7 cm ³
Manometer diameter:	160 mm
Bore for temperature sensor:	6 mm diam.
Temperature control connections:	7 mm diam.
Reducing valve connection:	$\frac{1}{8}$ " diam.
Standard gas connection:	3.5 mm diam.
Dimensions:	380x200x400 mm ³
Weight:	7 kg approx.

Contents:

- 1 Critical point apparatus filled with hydraulic (castor) oil but without test gas (SF_6). Includes built-in safeguarded connection nozzle for MINICAN® gas canisters
- 1 Oil filling device
- 1 Angled 1.3-mm hexagonal spanner (for grub screw on rotary scale)
- 1 Plastic hose, 3 mm internal diameter
- 1 $\frac{1}{8}$ " pipe screw connection (SW 11)
- 1 Grease gun

U104001

Additionally required:

U144002-230 Immersion/Circulation Thermostat (230 V, 50/60 Hz)

or

U144002-115 Immersion/Circulation Thermostat (115 V, 50/60 Hz)

U10146 Silicone tubing, 1 m (2x)

U11853 Digital quick-response pocket thermometer

U11854 Immersion Sensor, NiCr-Ni, type K, -65°C – 550°C

Sulphur hexafluoride SF_6

Additionally required in case of degassing hydraulic oil:

U10401 Castor Oil

High-Power Vacuum Pump

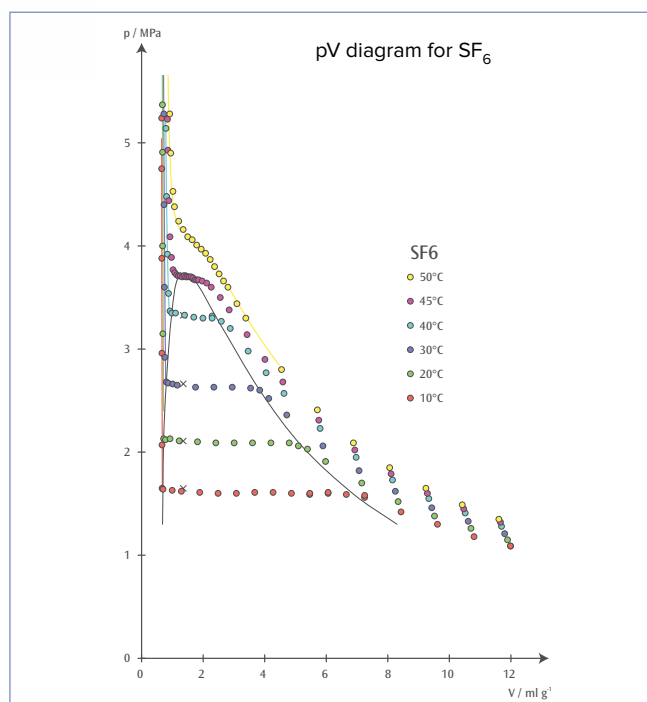

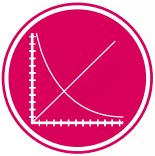

UE2040300
PDF online

U11853

U11854



U104001

U144002-230
U144002-115

Note:

In accordance with good laboratory practice, it is advisable to obtain gas via a fixed pipeline if the critical-point apparatus is used frequently. In case of occasional usage, it is more expedient to obtain the test gas from MINICAN® canisters. A MINICAN® gas connection is designed similarly to the valve on a common spray can, i.e. it is opened simply by fitting the MINICAN® on the gas connection nozzle.

Set of Seals (not shown)

Set of spare seals for critical point apparatus (U104001). Includes a rubber cap seal, round rubber seal of diameter 60 mm, square rubber seal 78x78 mm², a sealing ring of diameter 30/20 mm, four copper sealing discs and a threaded bush made of POM (Polyoxymethylene).

U10402

Castor Oil (not shown)

250 ml of DAB approved castor oil for filling critical point apparatus (U104001).

U10401

Accessories for Kinetic Gas Theory

Accessories for vibration generator (U56001) for simulating particle motion in an ideal gas. Differently coloured spheres (gas model) are set in motion by mechanical vibrations.

Contents:

- 1 Plexiglas cylinder, length 300 mm
- 1 Circular disc
- 1 Set of spheres of different colours

U56004

Additionally required:

U56001 Vibration Generator

U8533600-230 Function Generator FG 100 (230 V, 50/60 Hz)

or

U8533600-115 Function Generator FG 100 (115 V, 50/60 Hz)

Immersion/Circulation Thermostat

Immersion/circulation thermostat for setting the temperature of a bath or external apparatus with non-flammable liquids at temperatures up to 95°C. The fully electronic continuous regulator and the powerful circulating pump ensure that the water in the bath is optimally stirred so that the temperature remains highly constant. The user-friendly menu and simple three-button operation guarantee that the equipment is easy to use. A single-row LED display indicates the desired temperature and the actual temperature. Excess temperature protection is set to a fixed value of 95°C and features both audible and visual alarms to enhance operating safety. Also included is the possibility of connecting a water cooler or heat exchanger to provide cooling by means of tap water.

Operating-temperature range: 25°C – 100°C

Temperature constancy: ±0.05°C

Heating power: 1.5 kW

Pump pressure: max. 0.2 bar

Delivery rate: max. 15 l/min

Bath volume: max. 5.5 l

Bath area / depth: approx. 145x161x150 mm³

Immersion/Circulation Thermostat (230 V, 50/60 Hz)

U144002-230

Immersion/Circulation Thermostat (115 V, 50/60 Hz)

U144002-115

U56004

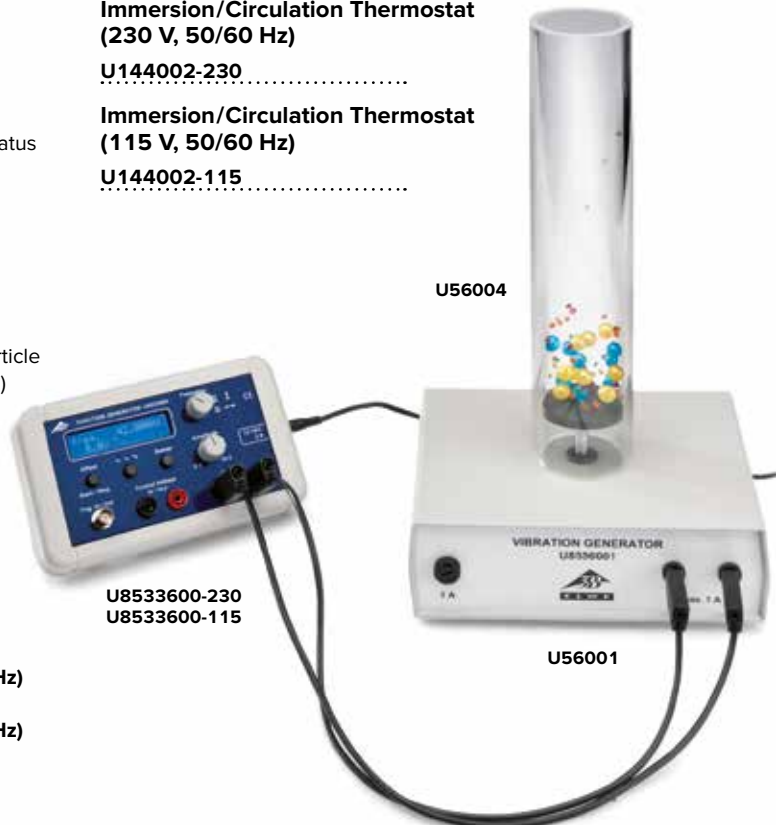

U8533600-230
U8533600-115

U56001

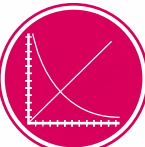
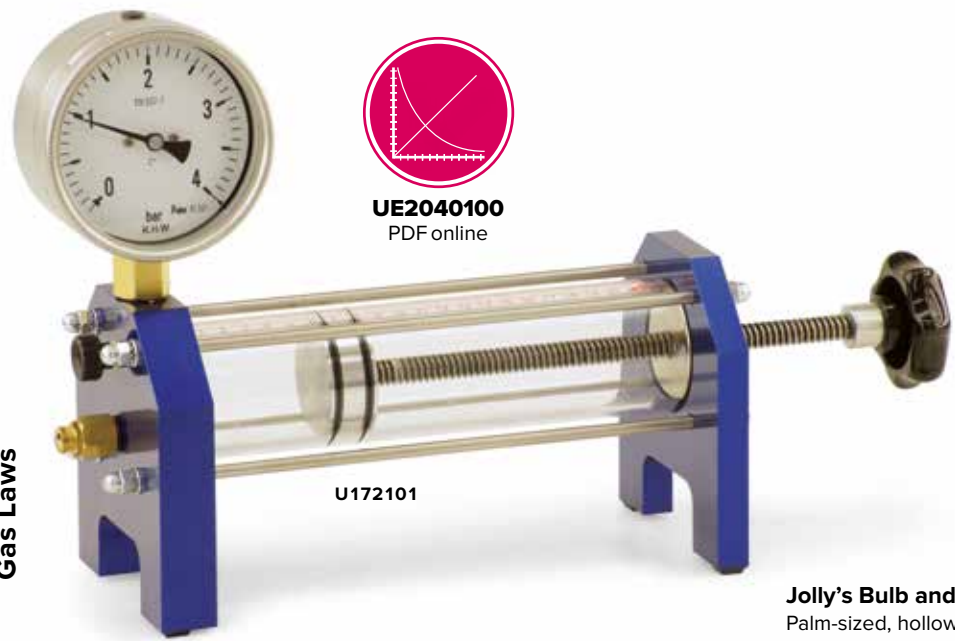

UE2040100
PDF online

U172101

Boyle's Law Apparatus

Apparatus for determining experimentally the relationship between gas volume and pressure at constant temperature (Boyle's law). The working cylinder is made of transparent acrylic and has a moving piston, scale and manometer. Along with a valve to let in gas or release it. The movement of the piston is achieved with the help of a threaded connecting rod turned by means of a turning knob. In this way, pressure both above and below atmospheric can be generated. For safety reasons, the working cylinder is enclosed in another protective transparent acrylic cylinder.

- Length: 300 mm
- Internal diameter: 40 mm
- Piston: 30 mm x 40 mm diameter
- Piston sealing: 2 ring gaskets
- Manometer diameter: 100 mm
- Permitted pressure: max. 4 bar

U172101

Pneumatic Lighter

Device for demonstrating the ignition of diesel. By swiftly pressing down the piston, the compressed air in the transparent tube is heated so strongly that a piece of paper placed at the bottom of the tube very clearly ignites. Similarly, a cotton-wool pad soaked in ether also catches fire.

- Length of compression tube: approx. 150 mm

U8741180

Spare Tube for Pneumatic Lighter (not shown)

Spare tube for pneumatic lighter (U8741180).

U8741185



U8741180

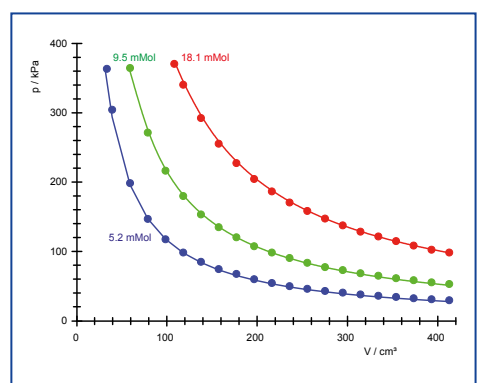

Pressure-volume diagram

U10710

Jolly's Bulb and Gauge

Palm-sized, hollow metallic ball with a manometer connected to it for demonstrating change of pressure in a closed volume of air when heated or cooled. Immersing the ball in a water bath at a specific temperature allows the relationship between pressure and temperature of the enclosed air to be investigated in order to demonstrate the behaviour of an ideal gas.

- Hollow ball: 60 mm diam.
- Manometer: 840 – 1240 hPa

U10710



Oscillation Tube

For determining adiabatic exponent c_p/c_v of air by Rüchardt's method, used in conjunction with Mariotte flask (U14327). Precision mesh tube with precisely fitting aluminium cylinder. If the glass tube is placed vertically on a glass flask of 10 l volume and the aluminium cylinder is allowed to slide into the glass tube, it can be made to undergo harmonic oscillations on the air cushion resulting from the enclosed volume of air. c_p/c_v can then be calculated from the period.

- Dimensions: 600 mm x 16 mm diam. internal
- Aluminium cylinder: 15.2 g

U14328

- Additionally required:
- U14327 Mariotte Flask**
- U11902 Digital Stopwatch**

- Additionally recommended:
- U205001 Vacuum Hand Pump**

U14328

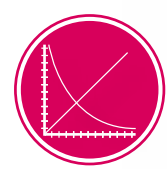

UE2040200
PDF online

U14327

Mariotte Flask

Duran glass flask with discharge opening at base and two rubber stoppers with boreholes. Volume: 10 l

U14327

- Additionally recommended:
- U14328 Oscillation Tube**



Experiment Topics:

- Recording and evaluating a pV diagram
- Operation of a Stirling engine as a heat pump or refrigerator
- Operation of a Stirling engine as a classical heat-engine

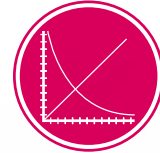

UE2060250
PDF online

Advantages

- Durability and high precision thanks to the use of high-quality materials
- Easily understood, transparent design allows the functioning to be viewed with ease
- Featuring built-in generator unit

Stirling-Engine G

Transparent Stirling engine for quantitative investigations of the Stirling cycle, as a heat engine, heat pump and refrigerating machine. The displacement cylinder and displacement piston are made of heat resistant glass; the power cylinder, flywheel and gearbox cover are made of acrylic glass. This allows very clear observation of the individual sequences of motion at all times. The crankshafts have ball bearings and are made of hardened steel. The connecting rods are made of wear resistant plastic. Includes spirit burner with adjustable wick for use as a heat source. The glass of the displacement cylinder is also equipped with recessed temperature measurement sockets before and behind the displacement piston, to allow measurements of temperature differences during operation as a heat pump or refrigerating machine. The large flywheel made of acrylic glass has imprinted markings to allow measurement of revolutions per unit of time using a light barrier. For recording pV-diagrams, it is possible to measure the pressure in the power cylinder via a hose connection; the string included in the scope of delivery can be fastened to the power piston to measure the stroke in order to determine the volume. The integrated engine generator unit with a two stage belt pulley allows a conversion of the produced mechanical energy into electrical energy. Equipped with a switchover option for operating an integrated lamp or external loads, or feeding electrical energy for operation as a heat pump or refrigerating machine, in accordance with the direction of rotation of the Stirling engine.

Power of the Stirling engine:	1.5 W
Idling speed:	1000 rpm
Flywheel:	140 mm diam.
Power cylinder:	25 mm diam.
Stroke of the power piston:	24 mm
Gas volume:	32 cm ³ – 44 cm ³
Motor generator unit:	max. 12 V DC
Belt pulley:	two stage (30 mm diam., 19 mm diam.)
Dimensions:	300x220x160 mm ³
Weight:	1.6 kg

U10050

Additionally recommended:

- U11323** Relative Pressure Sensor ± 1000 hPa
- U11371** Displacement Sensor
- U11372** Sensor Holder for Stirling Engine G
- U11310** 3B NET*lab*[™]
- U11300-230** 3B NET*log*[™] (230 V, 50/60 Hz)
- or
- U11300-115** 3B NET*log*[™] (115 V, 50/60 Hz)



U10050

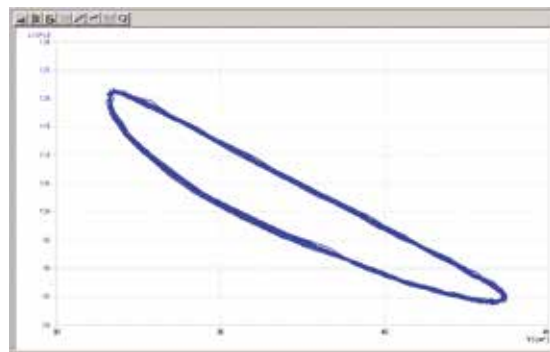

Pressure-volume diagram of Stirling engine G

Sensor Holder for Stirling Engine G

Holder for a relative pressure sensor (U11323) and a displacement sensor (U11371) for use with the G-series Stirling engine (U10050).

U11372

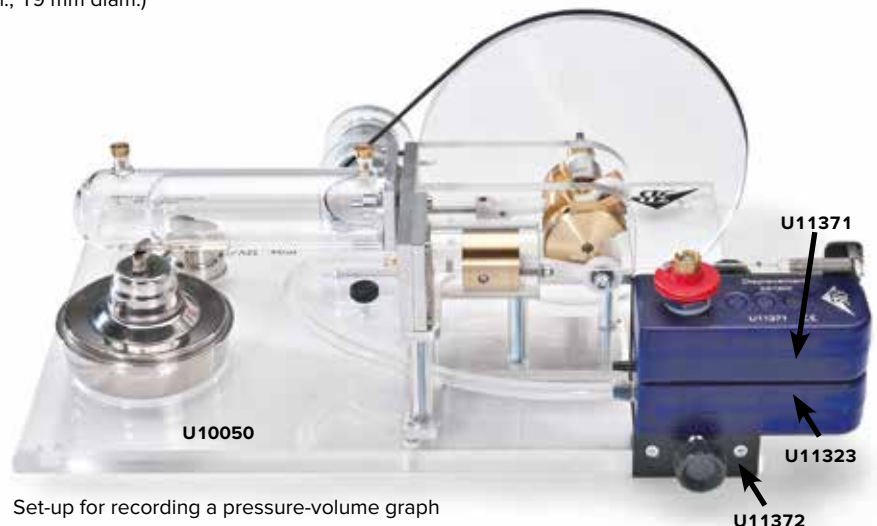

Set-up for recording a pressure-volume graph

Experiment Topics:

- Operation of a Stirling engine as a classical heat-engine
- Measurement of the no-load (idling) rate of rotation as a function of the heat input
- Recording and evaluating a pV diagram

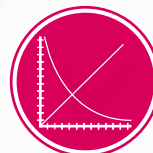

UE2060100
PDF online

U8440450

Advantages

- Slow running allows for the interaction between the displacement piston and working piston to be observed easily
- Discontinuous motion of the piston provides for almost perfect p-V (pressure-volume) diagrams
- It is possible for the system to be heated by absorption of radiant heat

Stirling Engine D

A functional model of a Stirling engine based on an idea by Professor Wilcke optimised for demonstrating to students the conversion of thermal energy into mechanical energy and the operation of a thermal engine, as well as investigating the Stirling cycle. The interplay between the displacement piston and the power piston can be seen especially clearly at a low rate of rotation. In this version the displacement piston moves discontinuously, with a dwell time during the heating of the working medium (air) and a second dwell time during its cooling. This offers a clearer demonstration of the ideal Stirling cycle than is possible with continuous piston movement. The heat source can be provided by an integrated electric hotplate, a candle flame, or focused adiation from the sun or from a lamp. In the latter case the direction of rotation will depend on whether the heat is applied from above or from below. For recording pV diagrams, the pressure can be measured via a rubber hose connection on the power cylinder, and the volume can be measured by attaching a thread to the power piston to follow its movement.

Heater voltage: 8 – 12 V, 1.5 A
 Gas volume: 330 cm³ – 345 cm³
 Flywheel rod: 400 mm
 Dimensions without flywheel rod: 260x185x330 mm³
 Weight: 2.2 kg

U8440450

Additionally recommended:

U11321 Relative Pressure Sensor ±100 hPa

U11371 Displacement Sensor

U8440455 Supplementary Set for Stirling Engine D

U11310 3B NETlab™

U11300-230 3B NETlog™ (230 V, 50/60 Hz)

or

U11300-115 3B NETlog™ (115 V, 50/60 Hz)



With discontinuous piston motion

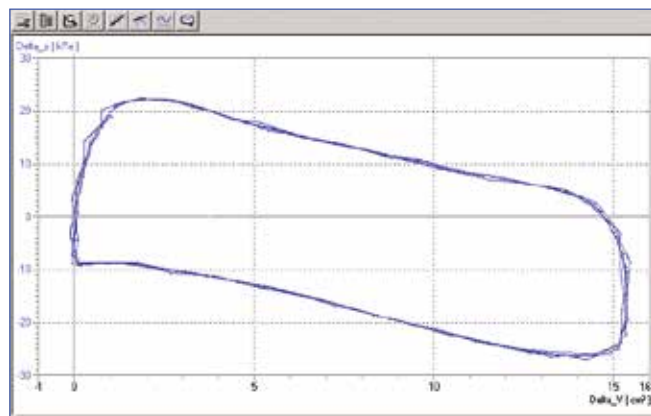

Pressure-volume diagram of Stirling engine D

Supplementary Set for Stirling Engine D

Set of equipment for adding a displacement sensor (U11371) and a relative pressure sensor (U11321) to the D-series Stirling engine (U8440450). The set consists of the following components:

- 1 Base plate to accommodate the pressure sensor
- 1 Knurled screw for fastening the base plate to a stand rod
- 1 Stem with magnetic base for displacement sensor
- 1 Silicone tubing for connecting ±100-hPa relative pressure sensor
- 1 Set of threads with suction pad
- 2 Weights with hook, 20 g each

U8440455



U8440455

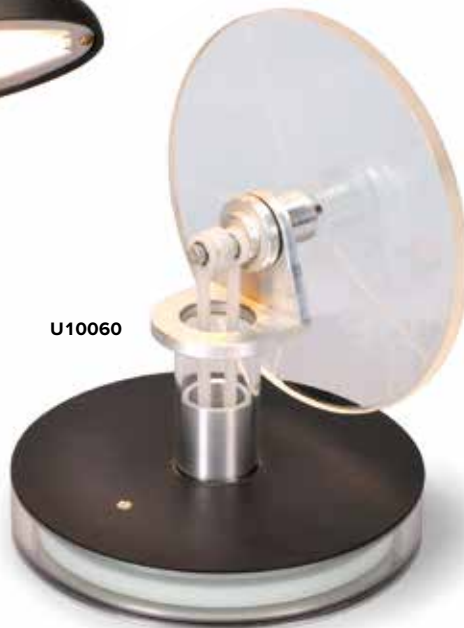

U10060



Advantages

- Runs with a temperature difference of just 5°C between the top and bottom plates
- Heat can be fed from below (e.g. heat from a human hand) or above (e.g. heat from the sun)
- Transparent components make it easy to view the functioning
- Also available in kit form

Low Temperature Stirling Engine

A compact, transparent Stirling engine for demonstrating the operation and fundamental design of such engines. A temperature difference of approximately 5° C between the base and top plates is sufficient to set the motor in motion. This difference can be generated just by the warmth of a human hand or by cooling through contact with a cold object from a refrigerator. The top plate's matt, black coat also enables the device to be operated as a solar-powered engine. In this case the direction of rotation will depend on whether the heat is applied from above or from below. The power cylinder is made of precision glass, while the displacement cylinder and flywheel are made of acrylic glass; this allows a clear observation of the movements of the power piston, displacement mechanism and crankshaft drive. The crankshaft and connecting rod have miniature precision ball bearings.

Rotation speed: 80 rpm at $\Delta T = 10^{\circ}\text{C}$
 Flywheel: 110 mm diam.
 Dimensions: 138 mm x 110 mm diam.

U10060.....



U10061

Low Temperature Stirling Engine, Assembly Kit

U10061.....

Stirling Engine S

This affordable Stirling engine comes complete with built-in alcohol burner. Red flywheels and chassis mounted on a green base, this all-metal engine runs silently at speeds in excess of 1,000 rpm. The engine demonstrates the principle of the Stirling cycle and the functioning of a classical heat engine. It comes completely assembled and ready to run, accompanied by the book "Stirling Cycle Engines" which explains the principles of operation.

Rotation speed: 1000 rpm
 Base plate: 180x110 mm²
 Weight: 1.15 kg

U49327.....

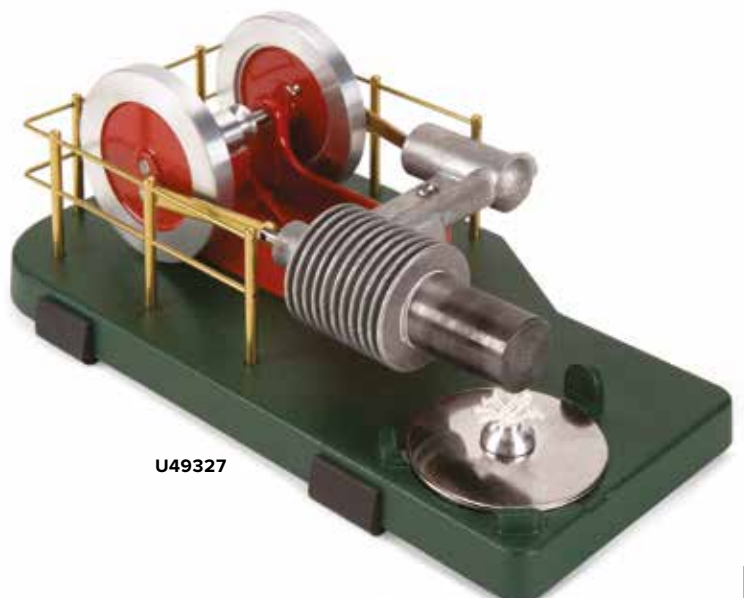

U49327

Advantages

- Very clear demonstration model with a compact and easily understood design
- The layout of the components matches the sequence of a heat cycle
- Inspection windows for observing how the refrigerant changes state

Heat Pump D

Demonstration model for showing how refrigerators and electrical compression heat pumps work. Consisting of compressor with drive motor, vaporiser, expansion valve and condenser. May be used as an air water or water water heat pump. Includes wattmeter, so that one can record the operation time, the mains voltage, instantaneous power input and electrical work, and two thermometers for measuring the temperatures in the two reservoirs. The components are connected in a closed system by copper pipes and mounted on a base board, and the clear layout makes it possible to directly relate the sequence of changes of state to the cyclic operation of the heat pump. Evaporator and condenser are constructed as copper tubing spirals and each of them is submerged in water filled containers serving as heat reservoirs for determining the heat absorbed or emitted. Two large manometers display the pressure ratios of the coolant in both heat exchangers. Two observation windows are provided for observing the state of aggregation of the refrigerant after the evaporator and after the condenser. A protective overpressure switch disconnects the compressor motor from the circuit when overpressure reaches 15 bars.

Compressor power: 120 W
 Coolant: R 134A, free of chloro-fluorohydrocarbons
 Temperature reservoirs: 2000 ml each
 Manometer: 160 mm diam.
 Dimensions: 560x300x630 mm³
 Weight: 21 kg

Heat Pump D (230 V, 50 Hz)

U8440600-230

Heat Pump D (115 V, 60 Hz)

U8440600-115

Experiment Topics:

- Determining the power output as a function of the temperature difference
- Analysing the cyclic process by means of a Mollier diagram

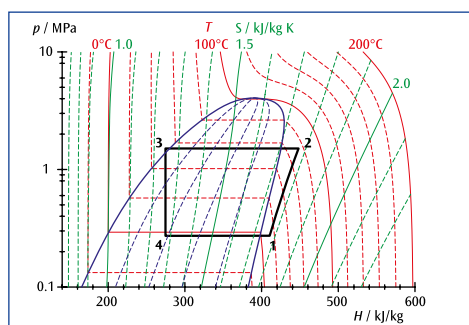

Pressure-enthalpy diagram of heat pump

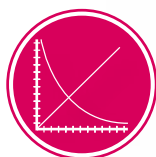
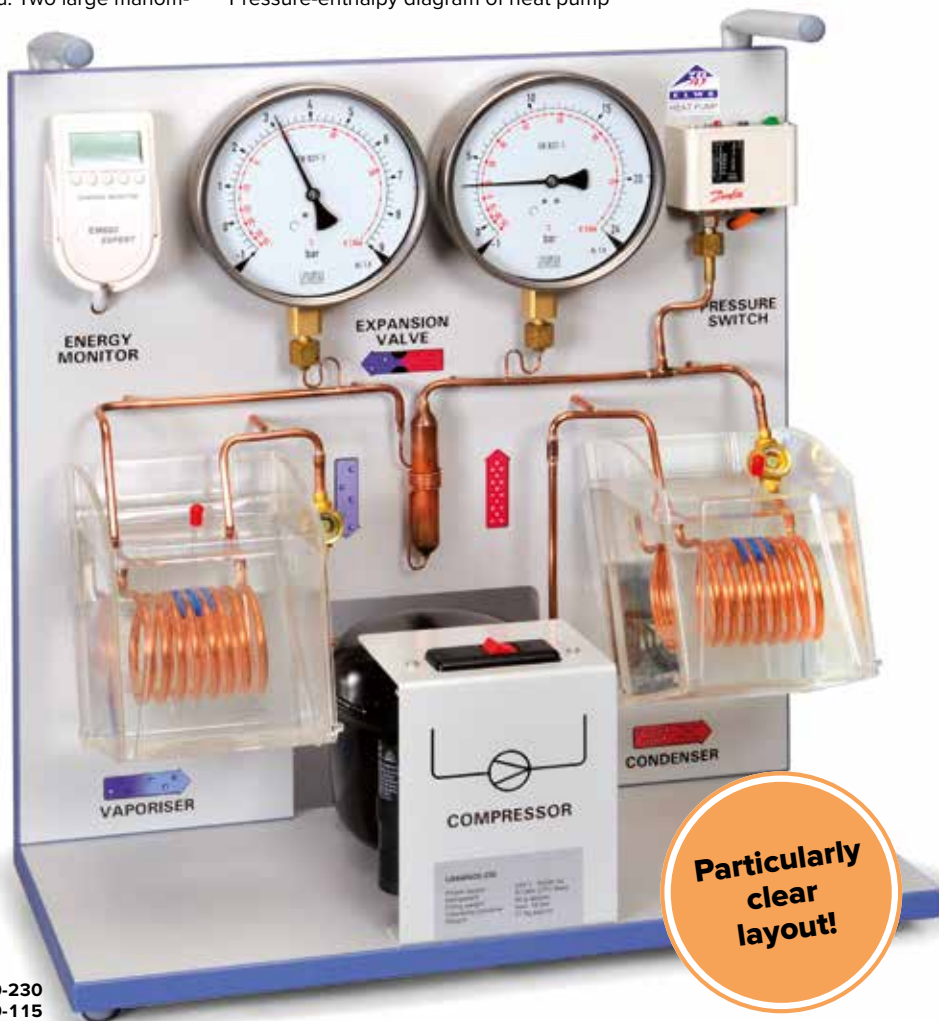

UE2060300
 PDF online

U8440600-230
 U8440600-115



U11329

Temperature Sensor, Pt100 with Measurement Terminal

Temperature sensor for the measurement of temperatures on the copper tubing of a heat pump (U8440600-230 or U8440600-115). Temperature sensor shaft made of rust-proof stainless steel. Tip with matching copper terminal. Can be used in conjunction with 3B NET-log™ unit (U11300-230 or U11300-115) for manual measurements or for processing measurement data when connected to a computer. Includes connector lead with 8 pin miniDIN plugs.

Measurement range: -50°C – 150°C
 Resolution: 0.1°C
 Accuracy: 0.1% of measured value plus 0.25°C
 Sensor cable: 1 m, with silicone insulation
 Sensor type: Pt100 thermocouple

U11329



U10055

Advantages

- Easily understood, transparent design allows the sequence of movements to be viewed simply
- Durability and high precision thanks to use of high-quality materials

Steam Engine G

Transparent steam engine for demonstrating how an oscillating steam engine operates. In this engine the cylinder moves around a centre axis. This motion causes the inlet port and outlet port of the steam conduit to open and close. The base plate and flywheel are made of acrylic glass, while the boiler and working cylinder are made of heat proof quartz glass, making all of the moveable parts and actions very clearly visible. With a ball bearing supported crankshaft made of brass and a safety valve built into the boiler to prevent excessive pressure. Includes spirit burner with adjustable wick for use as heat source.

Rotation speed: 800 rpm
 Mech. Power: 1 W
 Boiler volume: 50 ml
 Run time per load: 20 – 25 min
 Max. operating pressure: 0.5 bars
 Dimensions: 260x170x110 mm³

U10055

Steam Engine B

Steam engine model for demonstrating a cycle where the working substance (water and steam) changes phase. Includes a fixed brass cylinder which operates in both directions with a flywheel and drive wheel also operating in both directions, plus a centrifugal governor and a steam-jet oiling mechanism. Highly polished, nickel-coated brass boiler with an inspection window to show the water level, a spring safety valve and a domed steam whistle. The brass boiler is fitted onto old-copper-coloured boiler housing with a brick pattern and a chimney. The water is heated using dry fuel. A tray for collecting condensed water is located under the chimney, allowing it to “smoke” like a real steam train.

Base: 260x200 mm
 Height: 240 mm
 Flywheel: 70 mm diam.
 Boiler: 115x45 mm diam.
 Boiler volume: 155 ml
 Capacity: 120 ml approx.
 Weight: 1.3 kg

U13850

Dry Fuel for Steam Engine B (not shown)

20 Esbit fuel tablets for heating water in steam engine B (U13850).

U13851

Oil for Steam Engine (not shown)

Oil for lubricating pistons, cylinders and all other bearings of the B-model steam engine (U13850).

U13852

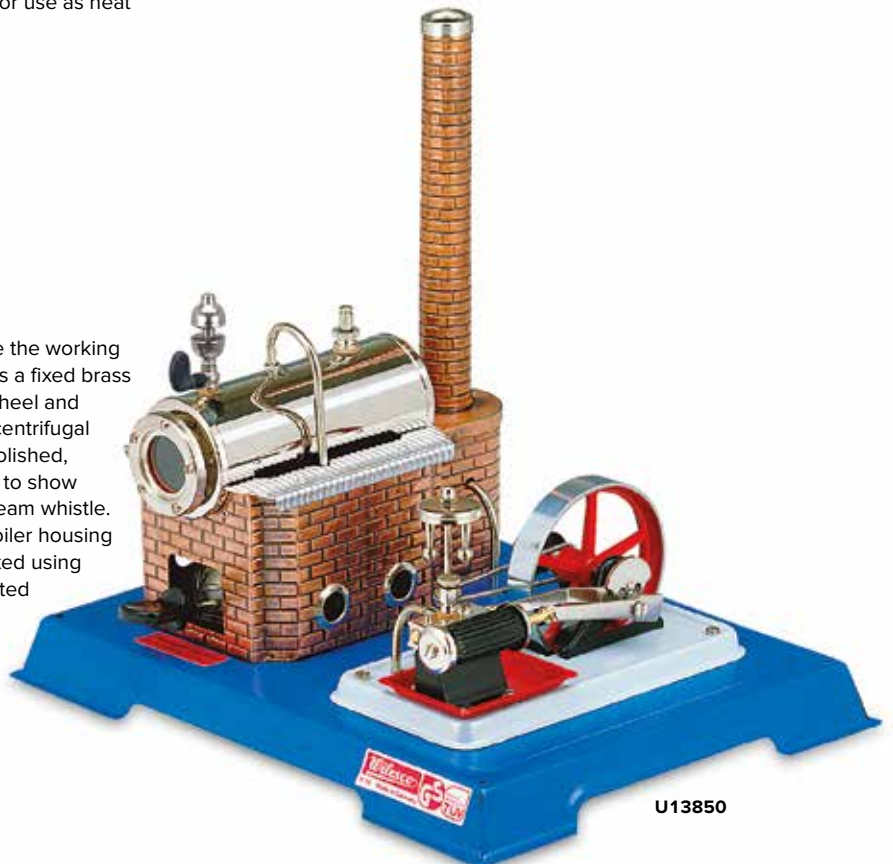

U13850

Experiment topics:

- Laws of reflection
- Laws of refraction
- Total reflection
- Minimum deflection angle for a prism
- Focal determination of mirrors and lenses
- Laws of lenses and image errors
- Shadow casting

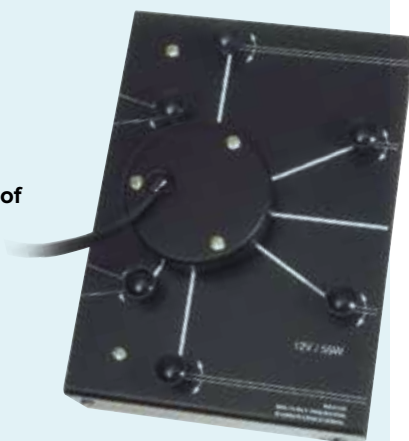

U40110

Multiple-Ray Projector, Magnetic

Light source for experiments demonstrating ray optics on a whiteboard (U10030 or U10031). In metal housing on magnetic foil. Experiments on reflection, refraction and basic lens laws can be performed using five narrow light rays which emerge from the right-hand side. With the help of rotating mirrors, these rays can be directed to make parallel, divergent or convergent beams, or can be masked out individually. Highly demonstrative experiments on shadow casting can be conducted using the two divergent light rays emerging from the left-hand side. With the help of rotating mirrors, these rays can be directed or masked out individually.

Lamp: 12 V, 55 W
 Connecting line: 1.5 m long with 4 mm plug
 Dimensions: approx. 150x200x50 mm³
 Weight: approx. 0.9 kg

U40110

Additionally required:

U13900-230 Transformer 12 V, 60 VA (230 V, 50/60 Hz)

or

U13900-115 Transformer 12 V, 60 VA (115 V, 50/60 Hz)

Advantages

- Ideally suited for demonstration experiments
- Experiments can be carried out without darkening the room
- Experiment set-ups and hand-written notes supplement one another to give an overall picture

Optics Kit for Whiteboard

Set of optical components for use in conjunction with a single-beam lamp (U40120) or multiple-beam lamp (U40110) on a whiteboard (U10030 or U10031). All components are lined with magnetic foil or furnished with a magnet holder and can be easily mounted and aligned on the whiteboard. This apparatus permits a wide range of experiments demonstrating ray optics without the need for a dark room; handwritten notes can be added to provide a clearer explanation.

U14600

Additionally required:

U10030 Whiteboard 600x900 mm²

or

U10031 Whiteboard 900x1200 mm²

U40120 Single-Ray Projector

U40121 Magnetic Holder for Single-Ray Projector

or

U40110 Multiple-Ray Projector



U14600

Contents:

Art. No.	Designation	Dimensions	Material
Mirrors:			
U15510	Plane mirror	200x35x35 mm ³	Plastic
U15511	Convex – concave mirror, $f = \pm 100$ mm	200x35x35 mm ³	Plastic
Transparent objects:			
U15515	Plano-concave lens, $f = -400$ mm	200x40x35 mm ³	Acrylic glass
U15516	Plano-convex lens, $f = +400$ mm	200x40x35 mm ³	Acrylic glass
U15517	Plane-parallel plate	200x100x35 mm ³	Acrylic glass
U15518	Semi-circular body, $f = +200$ mm	diam. 200x35 mm ²	Acrylic glass
U15520	Right-angled prism	200x200x35 mm ³	Acrylic glass
Shadow-casting bodies:			
	Cuboid	100x20x35 mm ³	Plastic
U15525	Cylinder	diam. 5x35 mm ²	Plastic
	Cylinder	diam. 60x35 mm ²	Plastic

Whiteboards

Metal board with enamelled surface for demonstration experiments using magnetic components, e.g., for mechanics or optics. Scratch and acid resistant steel board that can be written on using water soluble pens. Wall mounted.

Art. No.	Designation	Dimensions
U10030	Whiteboard	600x900 mm ²
U10031	Whiteboard	900x1200 mm ²



Single-Ray Projector

Light source for experiments demonstrating ray optics on a whiteboard (U10030 or U10031). With an adjustable aperture for producing a concentrated or divergent light beam.

- Lamp: 12 V, 35 W
- Connecting line: 1.5 m long with 4 mm plug
- Dimensions: approx. 120 mm x 70 mm diam.
- Weight: approx. 0.25 kg

U40120

Additionally required:
U40121 Magnetic Holder for Single-Ray Projector

- U13900-230 Transformer 12 V, 60 VA (230 V, 50/60 Hz)**
- or
- U13900-115 Transformer 12 V, 60 VA (115 V, 50/60 Hz)**

Halogen Lamp, 12 V, 35 W (not shown)
 Spare lamp for single-ray projector (U40120).

U40122

Magnetic Holder for Single-Ray Projector
 Magnet holder for mounting single-beam lamp (U40120) on a whiteboard (U10030 or U10031).

U40121

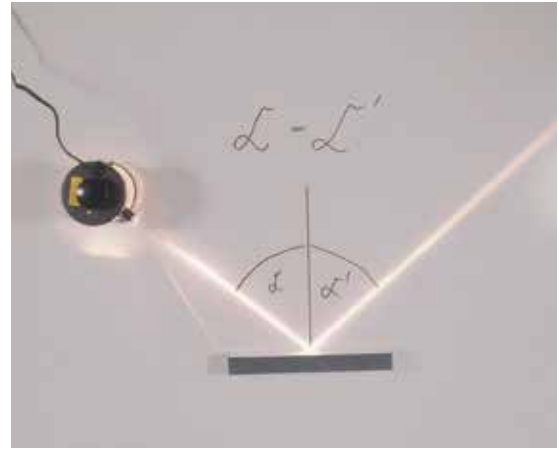

Reflection

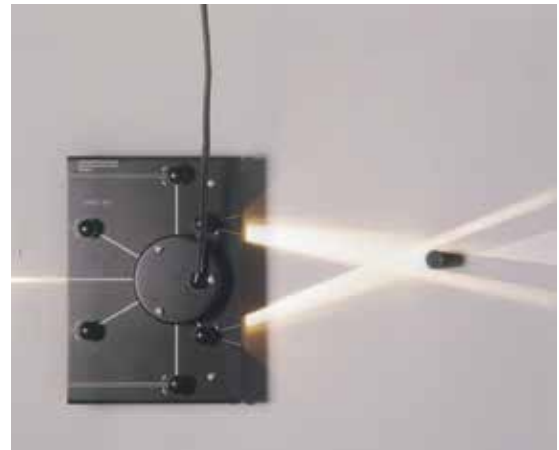

Shadow projection

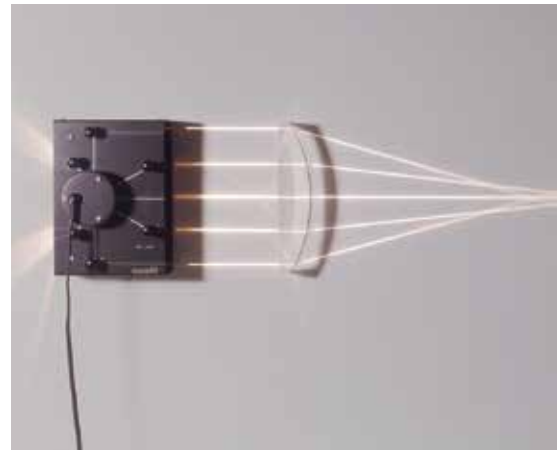

Lens errors

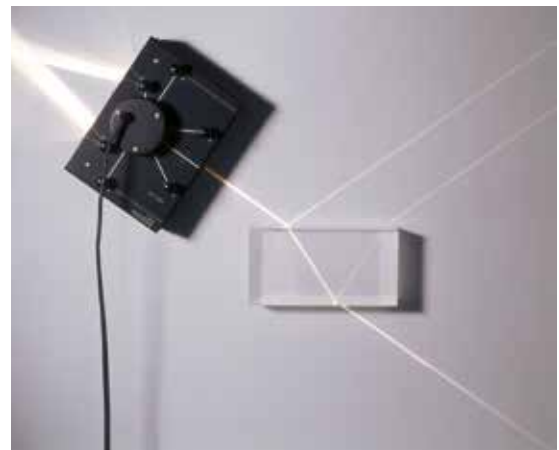

Refraction

Laser Ray Box

Laser diode capable of producing up to five parallel rays, for use with related board (U17306). In metal housing with magnetic foil. The number of emerging light beams can be selected electronically via switches. Power is supplied via a plug-in unit or batteries that are automatically disconnected after 60 minutes.

Diode laser: 5 beams, each max. 1 mW,
Laser safety class II
Wavelength: 635 nm
Separation of laser beams: 18 mm
Plug-in power supply: Primary 100 – 240 VAC,
Secondary 3 V DC, 300 mA
Battery compartment: for 2x 1.5 V AA-batteries
(batteries not included)
Dimensions: approx. 110x60x20 mm³

Laser Ray Box (230 V, 50/60Hz)

U17302-230

Laser Ray Box (115 V, 50/60 Hz)

U17302-115

Board for Laser Ray Box

Magnetic board for conducting experiments with laser ray box (U17302-230 or U17302-115). With a removable prop for inclining board.

Dimensions: app. 600x450 mm²

U17306



Equipment Set Optics with Laser Ray Box

Set of optical components for use in combination with a laser ray box (U17302-230 or U17302-115) and related board (U17306). This equipment set is ideal for conducting a wide variety of experiments on ray optics. Equipped with magnetic foil, the components can be easily attached to the board and aligned. Six work templates with pre-defined positions facilitate experiment setup. The beam paths can be observed from a relatively long way away without any need for darkening the room.

Basic length: 100 mm each (in most cases)

Thickness: 15 mm each

Contents:

- | | |
|------------------------------|---|
| 1 Biconcave lens | 1 Convex mirror |
| 4 Biconvex lenses | 1 Flat parallel block (60x100 mm ²) |
| 1 Plano-concave lens | 1 Prism |
| 1 Hemispherical body (45 mm) | 1 Wave guide (20x200 mm ²) |
| 1 Hemispherical body (75 mm) | 6 Work sheets (410x290 mm ²) |
| 1 Plane mirror | 1 Experiment guide |
| 1 Concave mirror | |

U17300

Additionally required:

U17302-230 Laser Ray Box (230 V, 50/60 Hz)

or

U17302-115 Laser Ray Box (115 V, 50/60 Hz)

U17306 Board for Laser Ray Box

Experiment topics:

- Law of refraction
- Law of reflection
- Total reflection
- Determining the focal length of curved mirrors and lenses
- Lens laws
- Correction of spherical aberration
- Short-sightedness and long-sightedness of the human eye and the correction of such defects
- Beam paths in cameras, microscopes and telescopes

Laser Optics Supplemental Set with Laser Ray Box

Supplementary kit to the demonstration laser optic set with laser ray box, consisting of 13 optical components for more advanced experiments on geometric optics, e.g. experiments using air lens that show why optical elements cause either negative or positive refraction. All components are coated with magnetic foil.

Base length: 100 mm each (in most cases)

Thickness: 15 mm each

Contents:

- | | |
|--------------------------------|--------------------------------------|
| 1 Biconcave lens | 2 Flat parallel blocks (rectangular) |
| 1 Biconvex lens | 2 Plane mirror |
| 1 Equilateral prism | 1 Biconcave "air lens" |
| 2 Rectangular prisms | 1 Biconvex "air lens" |
| 1 Flat parallel block (square) | 1 "Air prism" |

U17301



Experiment topics:

- Focal point of a converging lens
- Focal length
- Diverging lens
- Prism
- Parallel block



U21880

Five-Beam Optical Halogen Lamp 12 V, 55 W

Bright light source with five parallel light apertures for experiments involving ray optics to be conducted on a lab bench. In metal housing with integrated ventilation fan. Includes an adjustable reflecting mirror for setting the beam length. Thanks to a magnetic foil the lamp can also be used on a whiteboard.

Halogen lamp: 12 V, 50 W
 Connection: 4 mm safety sockets
 Slit width: 2 mm
 Slit spacing: 18 mm
 Housing dimensions: approx. 210x118x85 mm³

U21880

Set of Optical Components

In conjunction with the five-beam optical lamp (U21880), this equipment set is intended for experiments introducing students to geometric optics. The optical components are made of acrylic glass. Height: 15 mm each

Contents:

1 Planar-convex lens	1 Irregular prism
2 Bi-convex lenses	1 Plane-parallel plate
1 Bi-concave lens	1 Semicircular element
1 Equilateral prism	1 Cylindrical lens
1 Rectangular prism	

U15530



U15530

Additionally required:

U13900-230 Transformer 12 V, 60 VA (230 V, 50/60 Hz)

or

U13900-115 Transformer 12 V, 60 VA (115 V, 50/60 Hz)

U15530 Set of Optical Components

Experiment topics:

- Reflection and refraction of light by semicircular elements and prisms
- Snell's law
- Critical Angle



U17307-230
U17307-115

Optical Disc with Diode Laser

Set of apparatus for a comprehensive and easily understandable introduction to the basic principles of refraction and reflection of light by means of demonstration or student experiments. The laser can be easily attached via its built-in magnet and aligned on the end of the metal base. The rotating optical disc has an angular scale with 1° divisions and marked lines to position the elements. The set includes a semi-circular disc and an equilateral prism for use in optical experiments, as well as a plug-in mains-adaptor power supply and a battery compartment (batteries are not included in the apparatus as supplied).

Diode Laser: 1 beam, Class II
 Output power: <1 mW
 Wavelength: 635 nm
 Operating voltage: 3 V DC
 Battery-box: for 2x 1.5 V batteries (AA, LR6, MN1500, Mignon)

Laser ray box: 80x25x21 mm³
 Metal base: 320x40x35 mm³
 Optical disc: 250 mm diam.
 Semicircular element: 90 mm diam.
 Prism: 100 mm equilateral

Optical Disc with Diode Laser (230 V, 50/60 Hz)

U17307-230

Optical Disc with Diode Laser (115 V, 50/60 Hz)

U17307-115

Additionally recommended:

U21887 Semicircular Cell

U21887



Semicircular Cell

Graduated cell with 1 mm scale division, made of acrylic glass.
 Dimensions: 200 mm diam.
 Height: 20 mm

U21887

With a dependability that has been proven over the course of decades, the Kröncke optical system provides the precision necessary for student exercises and practical experiments in a wide range of experiments on ray optics and wave optics.

All optical components are mounted in diaphragms with no stem and can easily be moved up and down on an optical rider, perpendicular to the popular optical axis for the purpose of precise adjustment. The optical riders can be freely moved along the optical bench's U-shaped profile and secured by means of a simple clamping mechanism.

Optical Bench K

Optical bench made of black anodised aluminium profile with printed millimetre scale.

Cross-section: approx. 70x30 mm

Art. No.	Length	Weight
U8475260	2000 mm	2.4 kg
U8475240	1000 mm	1.2 kg
U8475230	500 mm	0.6 kg

! Advantages

- Rugged design
- Rapid set-up
- Extensive accessories

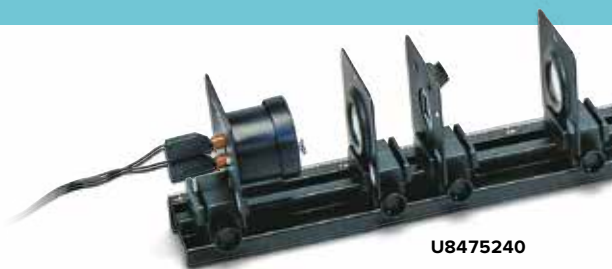

U8475240



U8475350

U8475230

Optical Lamp K

Halogen lamp in cylindrical housing attached to diaphragm screen (100x100 mm²) for mounting on optical rider K (U8475350).

The filament can be aligned horizontally or vertically.

Halogen lamp: 12 V, 20 W

Terminals: 4 mm safety sockets

Dimensions: approx. 60x100x100 mm³

Weight: approx. 130 g

U8475400

Additionally required:

U8475470-230 Transformer 12 V, 25 VA (230 V, 50/60 Hz)

or

U8475470-115 Transformer 12 V, 25 VA (115 V, 50/60 Hz)



U8475400

Optical Rider K

Optical rider for K-model optical benches (U8475260, U8475240 and U8475230). With two clamps for diaphragms from the Kröncke optical system or for plates up to 2 mm thick.

Dimensions: approx. 40x50x35 mm³

Weight: approx. 70 g

U8475350

Halogen Lamp 12 V/20 W (not shown)

Special substitute lamp for the optical lamp K (U8475400).

U8475410

Prism Table K

Prism table with clip for clamping prisms. Holder fits the optical rider K (U8475350).

U8476110



U8476110

Micrometer Screw K

Micrometer screw with fine tip for measuring diffraction and interference lines. Holder fits the optical rider K (U8475350).

Dimensions: approx. 80x30x60 mm³

Weight: approx. 120 g

U8476630

Plane Mirror K

Simple plane mirror, glass.

Dimensions: 100x100 mm²

Weight: approx. 70 g

U8475180

Concave Mirror K

Concave mirror on diaphragm screen 100x100 mm².

Focal length: 180 mm

Mirror diam.: 32 mm

Dimensions: 100x100 mm²

U8475205

Iris Diaphragm K

Continuously adjustable iris on diaphragm screen 100x100 mm².

Aperture: 2 – 18 mm

Dimensions: 100x100 mm²

U8472345



U8476630



U8475180



U8475205



U8472345

Optical Lenses K

Lenses made of high-grade optical glass. Shock-proof and crack-proof installation in optical diaphragm (100x100 mm²). With focal length specification.
 Dimensions: 100x100 mm²
 Lens diameter: 32 mm



U8475901 – U8475941



U8475951 – U8475961

Art. No.	Designation
U8475901	Convex Lens K, f = 50 mm
U8475911	Convex Lens K, f = 100 mm
U8475921	Convex Lens K, f = 150 mm
U8475925	Convex Lens K, f = 200 mm
U8475931	Convex Lens K, f = 300 mm
U8475941	Convex Lens K, f = 500 mm
U8475951	Concave Lens K, f = -100 mm
U8475961	Concave Lens K, f = -500 mm



U8476515



U8776140

Storage Box

Box made from smoked beech, varnished, with 20 compartments for lenses and optical elements of width 100 mm.

Dimensions: 400x130x90 mm³

Weight: approx. 1,000 g

U8776140

Projection Screens K

(not shown)
 Plastic projection screens for mounting on optical rider K (U8475350).

Dimensions: 200x150 mm²

Projection Screen K, transparent

U8476310

Projection Screen K, white

U8476320

Fresnel Mirror K

Fresnel mirror with holder for use on K-model optical benches (U8475260, U8475240 or U8475230). Two mutually inclined surface-coated mirrors are bonded to a common metal plate. A knurled screw at the rear can be used to adjust the angle between the mirrors. The wave nature of light can be demonstrated by interference following reflection at both mirrors. Holder matches the optical rider K (U8475350).

Dimensions: 135x100x40 mm³

Weight: approx. 123 g

U8476515

Holder K for Diode Laser

Magnetic holder for diode laser (U22000 or U22001). On diaphragm screen 100x100 mm².

U8475550

Clamp K

Tough clamp for diaphragms, filters, diffraction objects and other objects in a slide frame (see as of page 161). On diaphragm screen 100x100 mm².
 Clamping range: 0.2 – 4 mm
 Dimensions: 100x100 mm²
 Round opening: 38 mm diam.

U84755401

Adjustable Slit K

Continuously adjustable slit on diaphragm screen (100x100 mm²). The slit width can be adjusted by means of a micrometer screw.

Slit width: 0 – 3 mm

Slit height: 25 mm

Dimensions: 100x100 mm²

Weight: approx. 240 g

U8476675

Pair of Polarsation Filters K

Two polarising filters on a diaphragm screen (100x100 mm²) for producing and analysing polarised light. In a rotating frame with a pointer and protractor scale.

Scale: 0 – 180°

Scale division: 5°

Dimensions: 100x100 mm²

Filter diameter: 32 mm

U8476526



U84755401

U8476675

U8476526

U8475550

The inexpensive NEVA optics system offers reliability and ease of use for setting up basic experiments in ray optics.

All the optical components are set in a slide with a magnetic base and can easily be aligned on a sturdy optical base and moved into a beam of light.



U8470465

Optical Bench N

Metal rail with millimetre scale and guide slots for accommodating optical components on a magnetic base.

Dimensions: 400x75x10 mm³
Weight: 230 g approx.

U8470465

Optical Lamp N

High-powered white LED in a plastic housing with a magnetic base. Includes 5-V-DC, 1000-mA plug-in power supply.

Dimensions: 90x70x70 mm³
Weight: 200 g approx.

Optical Lamp N (230 V, 50/60 Hz)

U8478090-230

Optical Lamp N (115 V, 50/60 Hz)

U8478090-115



U8478090-230

Optical Lenses N

Lenses made of high-quality optical glass. Breakage and impact-resistant, set in a slide with magnetic base.

Dimensions: 70x70 mm²
Lens diameter: 36 mm

Art. No.	Designation
U8470130	Convex Lens N, f = +50 mm
U8470120	Convex Lens N, f = +100 mm
U8470110	Convex Lens N, f = +300 mm
U8470140	Concave Lens N, f = -100 mm



U8470110 – U8470140



U8478080-230

Parallel Light Optical Lamp N

Light source for parallel and divergent beams based on a high-powered white LED in a plastic housing with a magnetic base. The outlet side for parallel light has a slot for a slide and there is also a side for outputting divergent beams. Includes 5-V-DC, 1000-mA plug-in power supply.

Dimensions: 90x70x70 mm³
Weight: 400 g approx.

Parallel Light Optical Lamp N (230 V, 50/60 Hz)

U8478080-230

Parallel Light Optical Lamp N (115 V, 50/60 Hz)

U8478080-115

Projection Screen N

Angled, white-painted metal projection screen for horizontal or vertical use or placement beyond the N-model optical bench (U8470465).

Screen area: 120x170 mm²

U84780301



U84780301

Object Holder N

Object holder with magnetic base to accommodate optical apertures in slides (50x50 mm²), e.g. single slit N (U8470870) or triple/quintuple slit N (U8478110).

U8470350



U8470350

Single Slit N

Single slit slide for mounting in N-model object holder or in the filter slot of the N-model parallel light optical lamp to use in optical experiments requiring a tight single beam.

Dimensions: 50x50 mm²

U8470870



U8470870

Triple/Quintuple Slit N

Slide with a triple and a quintuple slit arrangement for mounting in N-model object holder (U8470350) or in the slide slot of the N-model parallel light optical lamp (U8478080-230 or U8478080-115) to use in optical experiments requiring multiple tight beams.

Dimensions: 50x50 mm²

U8478110

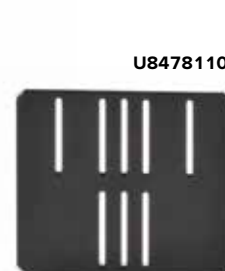

U8478110

Experiment topics:

- Demonstration of various light beams
- Reflection of a light ray by a plane mirror
- Reflection of a beam of rays by a plane mirror
- Reflection of a beam of rays by a concave/convex mirror
- Snell's law of refraction
- Refraction by a plane-parallel plate
- Refraction by a prism
- Inverting prism
- Concave and convex lenses

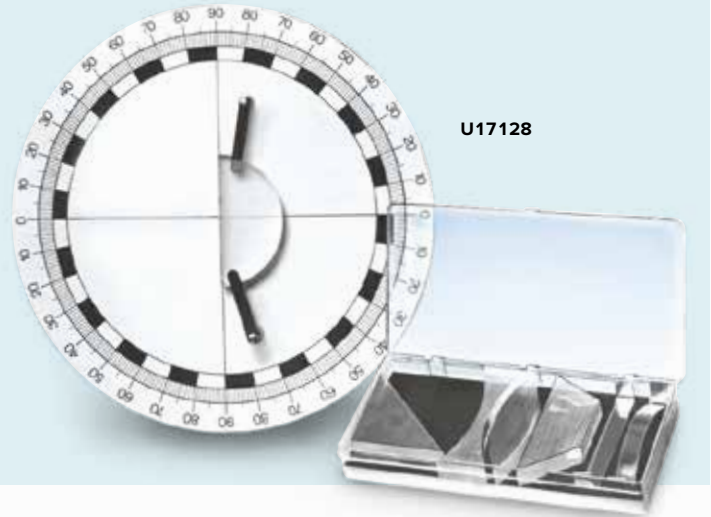

Optical Disc with Accessories

This equipment set introduces the fundamentals of geometric optics. It consists of a base plate with an angular scale possessing 1° divisions, a block scale and two bore holes for mounting clamps for optical components (lenses, prisms, mirrors). An adjustable holder and tripod permit horizontal as well as vertical installation.

Delivered with a storage case, this equipment set comprises the following items:

- 1 Optical disc with a holding stem and 2 clamps, 240 mm diam.
- 1 Bi-concave lens, 90 mm
- 1 Bi-convex lens, 90 mm
- 1 Semi-circular element, 90 mm
- 1 Trapezoid element, 45° and 60°
- 1 Prism, rectangular, leg length 50 mm
- 1 Combined mirror (planar, convex, concave)

U17128

Optical Rider U

Optical rider for U-model optical benches (U17150 and U17151) for mounting optical attachments on a stem. A smooth base ensures easy movement on the optical bench. Clamping width for stems: 10 mm

Art. No.	Sleeve height
U17160	75 mm
U17161	30 mm

Optical bench U

Comprising a solid aluminium profile, anodised with natural finish, robust and resistant to twisting, with mm scale along the full length. For experiments with optical attachments on a stem. Cross-section: approx. 100x40 mm²

Art. No.	Length	Scale length	Weight
U17150	1200 mm	1000 mm	approx. 3.0 kg
U17151	600 mm	500 mm	approx. 1.5 kg

Additionally recommended:

- U17150 Optical bench U, 120 cm
- U17160 Optical rider U, 75 mm (3x)
- U17161 Optical rider U, 30 mm
- U17140 Experiment lamp, halogen
- U8474000 Object holder on a stem
- U17103 Convex lens, $f = +150$ mm
- U17040 Set of slits and apertures
- U13900-230 Transformer 12 V, 60 VA (230 V, 50/60 Hz) or
- U13900-115 Transformer 12 V, 60 VA (115 V, 50/60 Hz)

Pair of Rail Supports

Two support feet made of natural-finish, anodised aluminium for U-model optical benches (U17150 and U17151). Dimensions: 220x20x15 mm³

U171661



Swivel Joint with Scale

Connecting piece for articulated linking of two U-model optical benches (U17150 and U17151). Profile rails. 90° articulation angle in both directions. Natural-finish, anodised aluminium. With a mounting for optical attachments on a stem at the axis of rotation. Clamping width for stems: 10 mm. Scale division: 5°. Dimensions: 180x82x100 mm³

U17165



U10301



Advantages

- Durability
- Tough, three-sided profile
- Millimetre precision

Optical Precision Bench D

Optical precision bench with a triangular profile for research and demonstration experiments requiring maximum accuracy. Made of black, anodised aluminium. Tilt-proof, slip-proof, resistant to bending and twisting, equipped with a full-length scale with cm/mm divisions. Bore holes on front end for securing connecting elements for additional rails or swivel joint (U10305). Cross-section: approx. 90x60 mm³

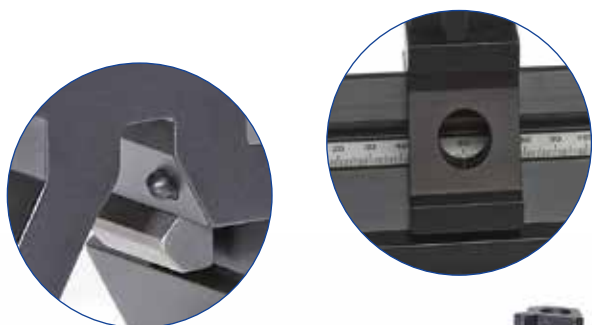

U10300

Art. No.	Length	Weight
U10302	500 mm	approx. 1.75 kg
U10300	1000 mm	approx. 3.5 kg
U10301	2000 mm	approx. 7 kg

Optical Rider D

Optical rider for D-model precision optical benches (U10300, U10301 and U10302) for mounting optical attachments on a stem. For research and demonstration experiments requiring maximum accuracy. Made of black anodised aluminium. Thanks to a hole drilled in the middle of the base and an accompanying scale, it is possible to read off the position of the centre of the rider on the optical bench directly. The riders are preliminarily fixed to the optical bench via springy built-in plastic nipples until the grub screw is tightened. Long-term attachment is designed to protect the materials using a stainless steel pressure shoe rather than the point of a screw. The stems of the optical equipment placed on the bench are also designed to protect the materials in that they are clamped using a stainless bracket. Clamping width for rods: 10 – 14 mm

Art. No.	Sleeve height	Base width
U103101	60 mm	50 mm
U103111	90 mm	50 mm
U103121	120 mm	50 mm
U103151	60 mm	36 mm
U103161	90 mm	36 mm
U103171	120 mm	36 mm

Sliding Rider D

Optical rider with a mounting for optical attachments on a stem, adjustable vertically with respect to the optical axis. Sliding rider with micrometer screw for position adjustment.

Sliding range: ±12.5 mm
 Sleeve height: 90 mm
 Base width: 50 mm
 Clamping width for rods: 10 – 14 mm

U103202

Tilting Rider D

Optical rider for tilting optical elements out of the optical axis.

Sleeve height: 90 mm
 Base width: 50 mm
 Clamping width for rods: 10 – 14 mm
 Tilting range: 90°

U103301



U103101

U103111

U103121



U103202

U103301

Support for Optical Bench D

One rail support and a single-point support with screws for adjusting optical bench. Made of black, anodised aluminium.
Length of rail support: 270 mm

U103041



Swivel Joint for Optical Bench D

For experiments where light is deflected and where the highest precision requirements prevail. Black anodized aluminum with adjustable protractor scale $\pm 180^\circ$ in 1° divisions. Sleeve for holding optical elements shaft mounted.

Protractor scale: $\pm 90^\circ$
Sleeve height: 60 mm
Clamping width for rods: 10 – 14 mm

U10305

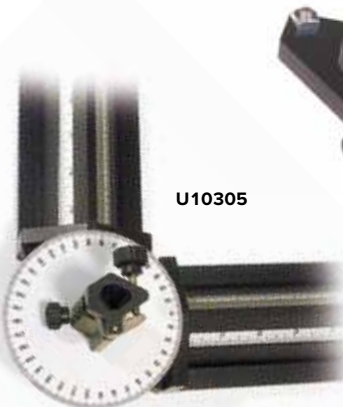

Optical Base D

Optical base used for mounting a U-shaped transformer core (U8497215) with coils and pole terminals for conducting experiments on the Faraday effect using precision optical bench D (U10300).

Dimensions: 148x85x60 mm³ approx.

U10319



Extension Arm D

Extension Arm to clamp on an optical rider D, for positioning optical elements out of the optical axis.

Extension arm: 100 mm
Clamping width for rods: 10 – 14 mm

U10331



Optical Lamp, Halogen

Ultra-bright light source for experiments on optical bench and for projection. It consists of a metal housing with a condenser, a movable element for axial light adjustment, a holding stem with a screw mounting and an integrated fan.

Halogen lamp: 12 V, 50 W
Connection: via 4 mm safety jacks
Condenser focal length: 75 mm
Condenser diameter: 45 mm
Stem: 120 mm x 10 mm diam.
Housing: approx. 190x125x110 mm³

U21881

Additionally required:
U13900-230 Transformer 12 V, 60 VA (230 V, 50/60 Hz)
or
U13900-115 Transformer 12 V, 60 VA (115 V, 50/60 Hz)

Spare Halogen Lamp, 12 V, 50 W

(not shown)
Spare halogen lamp for optical lamps (U17140 and U21881).

U13735



Experimental Lamp, Halogen

Light source with low-divergence beam for optical experiments. Black-painted metal housing on a stem, with fixture for vertical or horizontal set-up.

Halogen lamp: 12 V, 50 W
Connection: via 4 mm safety sockets
Light aperture: 40 mm diam.
Shaft diameter: 10 mm
Dimensions: approx. 80x80x105 mm³

U17140

Additionally required:
U13900-230 Transformer 12 V, 60 VA (230 V, 50/60 Hz)
or
U13900-115 Transformer 12 V, 60 VA (115 V, 50/60 Hz)



U22000

Laser Diode, Red

Red light source giving a beam with minimal divergence, housed in a compact and sturdy aluminium body. It is based on a 650 nm class II industrial laser module with a glass collimating lens. Fitted with a 10 cm stainless steel rod. A 100-230V AC/DC converter is included.

Laser protection class:	II
Output power:	0.9 – 1 mW at 20° C
Wavelength:	650 nm ± 5 nm
Spot size at 5 m distance:	< 8 mm diam.
Divergence:	< 1 mrad
Operating voltage:	6 – 12 V DC

U22000

Achromatic Objective – 10x/0.25

Microscope objective for diverging beam in conjunction with He-Ne laser U21840.

W30614

Objective for Beam Divergence

Microscope objective 4x mounted on an adapter for diverging the beam in conjunction with the red laser diode (U22000) or the green laser module (U22001).

U22002



Divergence of laser beam by a microscope objective.



U22002



U22001

Laser Module, Green

High performance 532 nm green laser (doubled NdYag). The laser (safety classification II) produces green light ideally suitable for optical demonstrations, as the wavelength is in the range where the human eye has maximum sensitivity. The visibility is as good as that for red laser light from a 5 mW source. Fitted with a 10 cm stainless steel stem. The apparatus supplied includes a plug-in mains-adaptor power supply.

Laser protection class:	II
Output power:	0.4 – 1 mW at 20° C
Wavelength:	532 nm ± 0.1 nm
Spot size at 5 m distance:	< 9 mm diam.
Divergence:	< 2 mrad
Operating voltage:	3 V DC

U22001

E14 Lamp Socket on Stem

E14 lamp socket on stem, with mains connection cable and Euro-plug conforming to CEE 7/16.

Shaft:	113 mm x 10 mm diam.
Weight:	approx. 135 g

U8473200-230

E27 Lamp Socket on Stem

E14 lamp socket on stem, with mains connection cable and earthed plug conforming to CEE 7/4.

Shaft:	113 mm x 10 mm diam.
Weight:	approx. 240 g

U8473210-230

He-Ne Laser

Monochromatic, coherent light source for optical experiments, e.g. on diffraction, interference, and hologram reconstitution. Anodised metal housing with key switch, neutral filter for attenuating beam, 2 stand rods and power supply unit. To widen the beam, microscope objectives (e.g. W30614) can be screwed to the beam aperture.

Laser protection class:	II
Output power:	< 0.2 mW (with neutral grey filter) < 1 mW (without neutral grey filter)

Wavelength:	633 nm
Beam diameter:	0.48 mm
Radiation divergence:	1.7 mrad
Mode:	TEM ₀₀
Polarisation:	Random
Service life:	> 12000 hours
Plug-in power supply:	12 V DC, 1 A
Dimensions:	approx. 230x55x90 mm ³
Weight:	approx. 0.8 kg

Contents:

- 1 Helium-Neon Laser
- 2 Keys
- 1 Long stand rod
- 1 Short stand rod, 6-edges
- 1 Transformer 12 V

U21840



U8473200-230

U8473210-230

U21840

Note:

All the components on stems illustrated on the following pages are supplied without an optical rider.

Lenses on Stem

Lenses in black frame on stem. With a lens protection ring for preventing damage to the lens.

Holder: 130 mm diam.

Shaft: 10 mm diam.

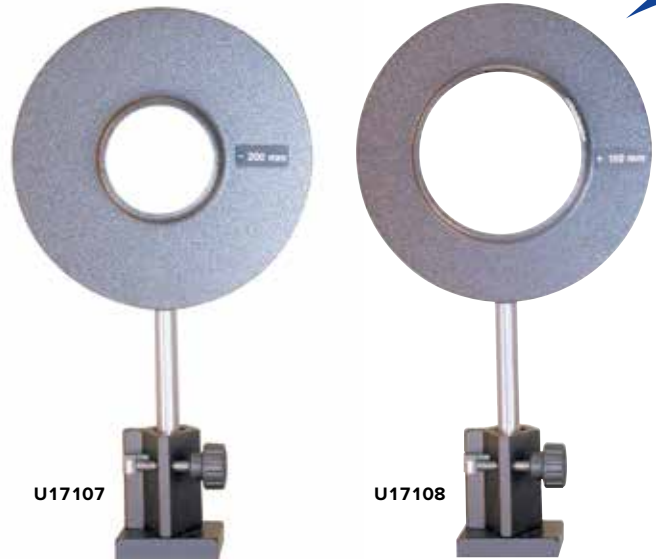

Art. No.	Designation	Focal length	Diaphragm diameter
U17101	Convex lens on stem	+50 mm	50 mm
U17102	Convex lens on stem	+100 mm	50 mm
U17103	Convex lens on stem	+150 mm	50 mm
U17104	Convex lens on stem	+200 mm	50 mm
U17105	Convex lens on stem	+300 mm	50 mm
U17108	Convex lens on stem	+150 mm	75 mm
U17106	Concave lens on stem	-100 mm	50 mm
U17107	Concave lens on stem	-200 mm	50 mm

Mirrors on Stem

Mirrors in black metal frame on stem. With protective ring for preventing damage to mirror.

Holder: 130 mm diam.

Diaphragm: 50 mm diam.

Shaft: 10 mm diam.

Art. No.	Designation	Focal length
U17110	Concave mirror, on stem	+75 mm
U17111	Convex mirror, on stem	-75 mm
U17112	Plane mirror, on stem	-

Variable Focus Lens

Transparent silicone lens, on stem. The radius of curvature of the soft silicone lens can be adjusted via the water pressure in the lens using a plastic syringe, e.g. for demonstrating the accommodation capacity of the eye. Includes plastic syringe and connecting tube.

Holder: 130 mm diam.

Lens: 65 mm diam.

Shaft: 10 mm diam.

U17109



U8474030



U17001



U22010



U22017



U8474015



U8474000

Component Holder on Stem

Holder on steel rod for supporting an optical component of circular shape. The component is held in place by a metal ring.

Aperture: 36 mm diam.
 Components: 7 mm x 42 mm diam. max.
 Height of optical axis: 150 mm
 Mounting: 100 mm diam.
 Stem: 10 mm diam.

U22010

Object Holder on Stem

Object holder in black metal frame on stem. With plug-in frame for diaphragms, filters, diffraction gratings and other objects in slide frame (see as of page 161). Includes panels to partially cover the inserted objects.

Metal frame: 130 mm diam.
 Plug-in socket: 50x50 mm²
 Shaft diameter: 10 mm

U8474000

Rotating Object Holder on Stem

Object holder in black metal frame on stem. With rotating, plug-in frame for diaphragms, filters, diffraction gratings and other objects in slide frame (see as of page 161) with protractor scale.

Holder: 130 mm diam.
 Plug-in frame: 50x50 mm
 Angular scale: ±90°
 Divisions: 5°
 Shaft: 10 mm diam.

U17001

Polarisation Filter on Stem

Precision glass polarisation filter, which is in a mounting on a steel rod and can be rotated on a ball-bearing. With angular scale marked in 1° intervals.

Aperture: 38 mm diam.
 Extinction coefficient: >99.9 % at $\lambda = 450 - 750$ nm
 Height of optical axis: 150 mm
 Mounting: 100 mm diam.
 Stem: 10 mm diam.

U22017

Adjustable Slit on Stem

Slit with symmetric aperture, in black metal frame on stem. With micrometer screw.

Holder: 130 mm diam.
 Slit width: 0 – 3 mm
 Slit height: 25 mm
 Shaft: 10 mm diam.

U8474015

Total Reflection Apparatus on Stem

Acrylic rod with bend in black metal frame on stem. Parallel light shone through the rod undergoes total internal reflection and is guided around the bent end.

Metall holder: 130 mm diam.
 Shaft: 10 mm diam.

U8474030



U21835



U17010



U17130



U8474050

Holder on Stem for Lenses without Frame

Holder with a clamp for mounting frameless lenses. In black metal frame on stem.

Holder : 130 mm diam.
Aperture: 40 mm diam.
Shaft: 10 mm diam.

U21835

Projection Screen

Translucent screen, on stem, for all projection purposes on optical bench.

Dimensions: 250x250 mm²
Shaft: 10 mm diam.

U17130

Iris on Stem

Iris diaphragm in black metal frame, shaft-mounted. Continuously adjustable diaphragm diameter.

Holder: 130 mm diam.
Iris diameter: 3 – 29 mm
Shaft: 10 mm diam.

U17010

Holder on Stem for Direct-Vision Prism

Holder with rotating mounting for direct-vision prism (U14020). In black metal frame on stem.

Holder: 130 mm diam.
Shaft: 10 mm dia

U8474050

Prism Table on Stem

Round prism table with a height-adjustable clamp, e.g. for fixing prisms. On stem for mounting on optical rider.

Table: 60 mm diam.
Shaft: 10 mm diam.

U17020

Storing Base for Lenses

Wooden strip with ten bore holes for storing instruments with 10 mm-shaft.

U17120



U17020



U17120



UE4030350
PDF online



U22018

Glass Inset for Newton's Rings Experiments

Optical component for demonstrating and investigating Newton's interference rings. Composed of flat and curved glass pane on a stem. Includes three adjustment screws for centring the interference module.

Height of optical beam: 150 mm
Usable diameter: 38 mm
Thickness of glass pane: 3 mm
Radius of curvature: 50 m
Diameter of setting: 100 mm
Diameter of stem: 10 mm

U22018

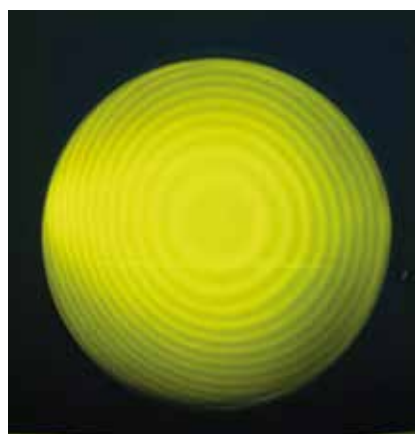

Newton's rings
in yellow light



U10345

Fresnel Mirror on Stem

This device is used to demonstrate the wave nature of light by observing interference caused by reflection at two mirrors and can be used to calculate the wavelength of light. It consists of two mutually inclined, front-coated mirrors made of black acrylic glass and fitted in black, anodised aluminium holders with firmly mounted mirror protection elements on a tripod made of high-grade steel. The angle of inclination can be finely adjusted from the rear.

Total mirror area: 30x95 mm²
Adjustment range: -0.3° – +0.7°
Shaft: 10 mm diam.

U10345

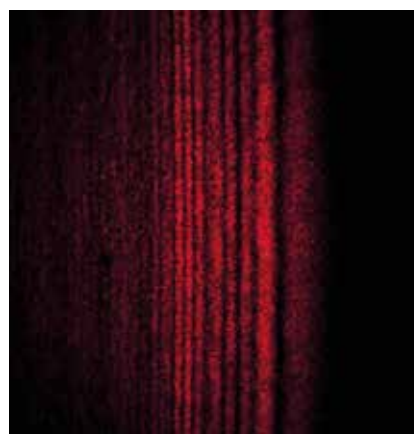

Interference pattern on
the observation screen

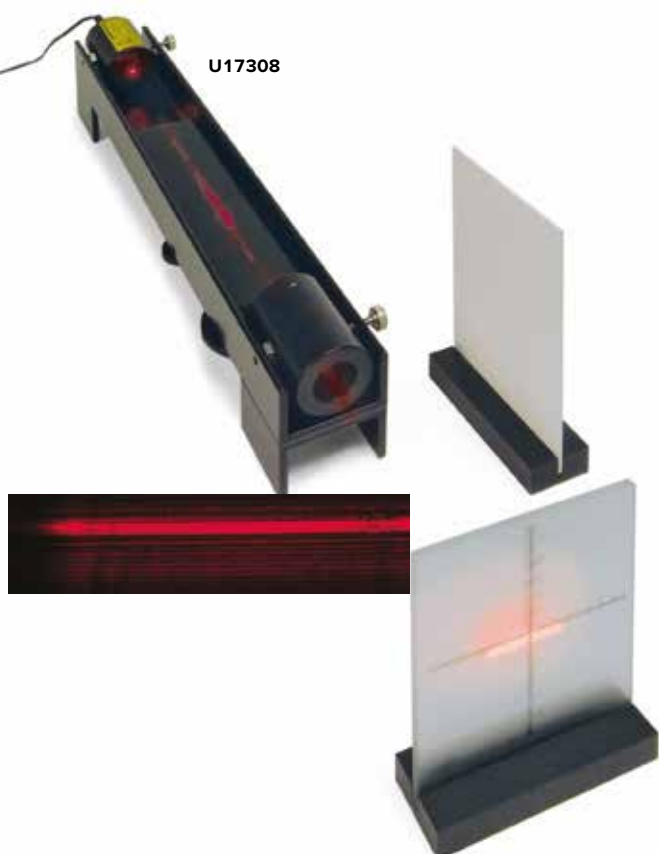

U17308

Fresnel Mirror Experiment Set

Complete equipment set for demonstrating the wave nature of light by observing the interference of laser light. This is caused by the reflection of a laser at two black planar glass mirrors which are offset by a small angle of a few degrees. The laser, mirrors and the optical projector are all mounted on a metal base. One mirror is fixed and the other is adjustable to change the angle of inclination. A projection screen, a ground glass screen with scaled crosshairs and a battery box are also included.

Diode Laser: class II
Output power: < 1 mW
Wavelength: 635 nm
Operating voltage: 3 V DC
Battery-box: for 2x 1.5 V batteries
(AA, LR6, MN1500, Mignon)
(batteries not included)

Dimensions:
Metal base: 400x75x85 mm³
Screens: 150x90x30 mm³

U17308

Additionally recommended:
U17309 Plug-In Power Supply 3 V DC

Plug-In Power Supply 3 V DC (not shown)
Plug-in mains adaptor to provide electrical power supply for the Fresnel mirror experiment set (U17308).
Mains voltage: 100 – 240 V, 50/60 Hz

U17309

Geometrical Objects

For fitting on an object holder on a stem (U8474000), in a rotatable object holder on a stem (U17001) or in a clamping holder K (U84755401).

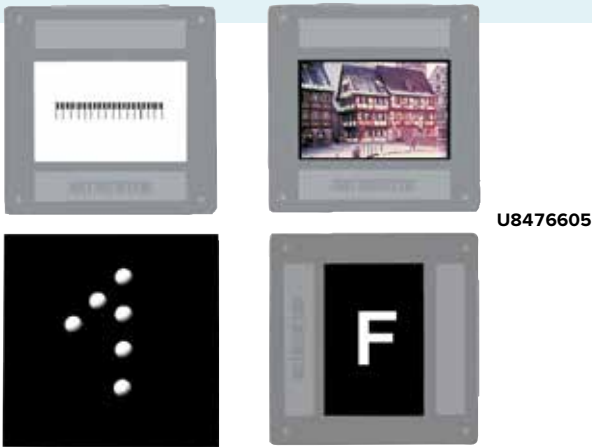

U8476605

Set of 4 Image Objects

Set of four image objects in a slide frame.

Dimensions: 50x50 mm²

Contents:

- 1 Scale, 15 mm with scale divisions of 0.1 mm
- 1 Photograph
- 1 F diaphragm
- 1 Number 1 diaphragm

U8476605

Set of 5 Hole Diaphragms

Five hole diaphragms of different diameters in a slide frame.

Hole diameter: 1/ 3/ 6/ 10/ 15 mm

Dimensions: 50x50 mm²

U8470800

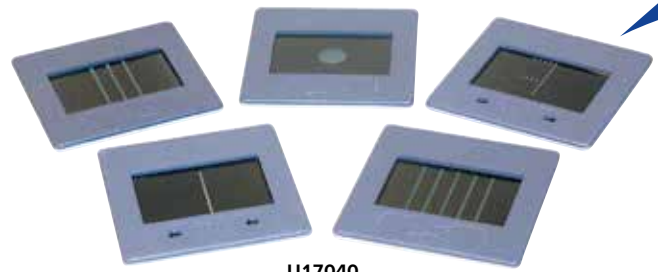

U17040

Set of 5 Slit and Hole Diaphragms

Five slit and hole diaphragms in a slide frame.

Dimensions: 50x50 mm²

Contents:

- 1 Slit, slit width 1 mm
- 1 Threefold slit, slit width 1 mm, slit spacing 5 mm
- 1 Fivefold slit, slit width 1 mm, slit spacing 5 mm
- 1 Apertured diaphragm, diam. 8 mm
- 1 F diaphragm

U17040

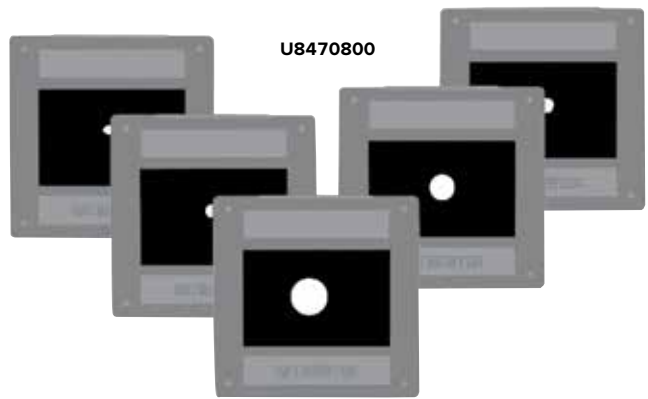

U8470800

Geometrical Objects

Suitable for mounting in the optical component holder (U22010).

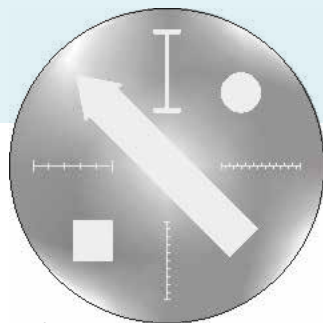

U22027

Geometrical Objects on Glass Plate

High quality, chrome-plated glass plate with four scales and three geometrical objects for quantitative experiments on geometric optics. The glass plate is highly resistant against ageing and contamination.

Diameter: 40 mm

Thickness: 1.5 mm

Length of scale: 10 mm

Graduation: 10 mm, 2 mm, 1 mm, 0.5 mm

Geometrical objects: Arrow 30 mm long
Square 5 mm side length
Disc 5 mm diam.

U22027



U287050

U287020

Frosted Discs

Glass discs with frosted surface. Suitable for use as frosted transparent object in optical experiments.

Diameter: 40 mm

Thickness: 2 mm

Frosted Disc with "d"

U287020

Frosted Disc

U287050

Diffraction Objects

For fitting on an object holder on a stem (U8474000), in a rotatable object holder on a stem (U17001) or in a clamping holder K (U84755401).

Transmission Grating

Transmission grating for spectroscopic examinations and for experiments on diffraction and interference. Suitable to resolve the Na-D lines. Mounted on glass carrier.

Dimensions: 38x50 mm²

Art. No.	Description	Lines/mm
U19512	Transmission Grating	300
U19511	Transmission Grating	600



U8470790

Set of 5 Single Slits

Five single slits of different widths in a slide frame.

Slit widths: 0.1/ 0.2/ 0.4/ 0.8/ 1.6 mm

Dimensions: 50x50 mm²

U8470790

Polarisation Filter

Set of two polarisation filters in a slide frame.

Dimensions: 50x50 mm²

U40129

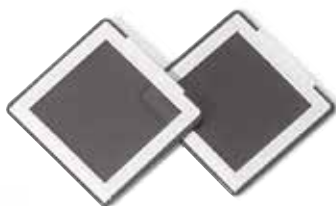

U40129



U21870

Hologram

Transmission hologram in slide holder.

Dimensions: 50x50 mm²

U21870

U19520

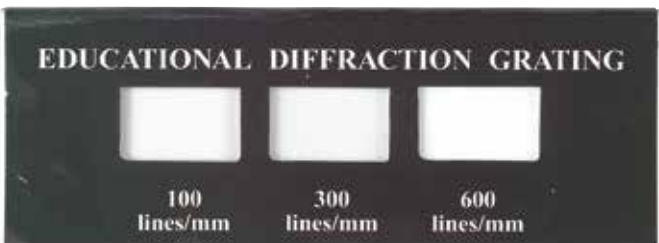

Diaphragm with a Single Slit and Rib

Photographic diffraction object in a slide frame.

Slit and rib width: 0.5 mm each

Dimensions: 50x50 mm²

U14107



U14107

Diaphragm with 3 Single Slits and 1 Double Slit

Photographic diffraction object in a slide frame.

Single slit widths: 0.075 / 0.15 / 0.4 mm

Double slit width: 0.1

Double slit spacing: 0.5 mm

Dimensions: 50x50 mm²

U8476600



U8476600

Copy of a Rowland Grating

This copy of a Rowland grating is supplied on a collodion foil between two glass plates in a metal frame for the purpose of projecting diffraction spectra, measuring wavelengths and observing spectra with spectrum lamps.

Number of lines: 600 Lines/mm

Dimensions: 50x50 mm²

U14424



U14424

Reflection Grating

Reflection grating for demonstrating visible spectra and UV-spectra of 1st and 2nd order and when inclined, of up to 5th order. Mounted on round, concave glass carrier.

Curvature radius: 500 mm

Number of lines: 530 lines/mm

Grating dimensions: 40x30 mm²

Glass carrier: 50 mm diam.

U19525

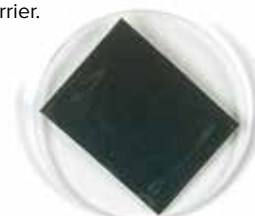

U19525

Demonstration Gratings

Three diffraction gratings on a frame for demonstrating the relationship between line spacing and diffraction angle.

Number of lines: 100/ 300/ 600 lines/mm.

Dimensions: 90x30 mm²

U19520

U847665

U847665

U14108

Diaphragms with Circular Holes and Discs

Photographic diffraction objects in a slide frame.

Dimensions: 50x50 mm²

Art. No.	Description	Diameter
U14108	Diaphragm with 3 Circular Hole and Disc Pairs	1.0/1.5/2.0 mm
U847665	Diaphragm with 9 Circular Discs	0.1 – 1.8 mm
U847665	Diaphragm with 9 Circular Holes	0.1 – 1.8 mm

U14100

U14101

U14102

Diaphragms with Double and Multiple Slits

Photographic diffraction objects in a slide frame.

Dimensions: 50x50 mm²

Art. No.	Description	Slit spacing	Slit width	No. of slits
U14100	Diaphragm with 3 Double Slits of Different Widths	0.3 mm	0.10/0.15/0.20 mm	2
U14101	Diaphragm with 4 Double Slits of Different Spacings	0.25/0.50/0.75/ 1.00 mm	0.15 mm	2
U14102	Diaphragm with 4 Multiple Slits and Gratings	0.25 mm	0.15 mm	2/3/4/5/40

U14103

U14104

U14106

Diaphragms with Gratings

Photographic diffraction objects in a slide frame.

Dimensions: 50x50 mm²

Art. No.	Description	Grating constant	Slit width	No. of lines
U14103	Diaphragm with 3 Ruled Gratings	0.5/0.25/0.125 mm	0.25/0.125/ 0.063 mm	2/4/8 Lines/mm
U14104	Ruled Gratings	0.125 mm	0.063 mm	8 Lines/mm
U14106	Diaphragm with 2 Cross Gratings	0.25 mm	0.125 mm	4 Lines/mm

Gratings

Line gratings in slide frames. For students and demonstration experiments.

Dimensions: 50x50 mm²

U21871

U21872

U21873

U21874

Art. No.	Description	Lines/mm
U21871	Grating	140
U21872	Grating	530
U21873	Grating	600
U21874	Grating	1000

Set of 4 Gratings

Four line gratings mounted in slide frame with protective glass plates.

For student and demonstration experiments.

Number of lines: 80/ 100/ 300/ 600 Lines/mm

Dimensions: 50x50 mm²

U19515.....



Diffraction Objects on Glass Plates

Suitable for mounting in the optical component holder (U22010). Chromium-coated glass plates with diffraction objects of high precision and regularity applied by microlithography. The glass supports are highly resistant against ageing and contamination.



U22011

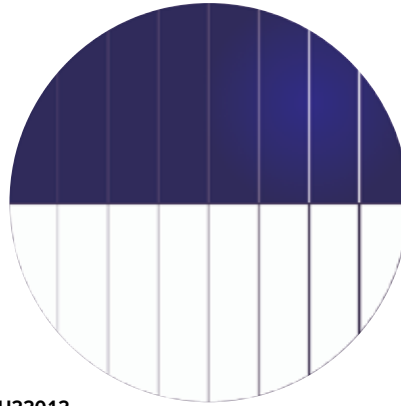

U22012

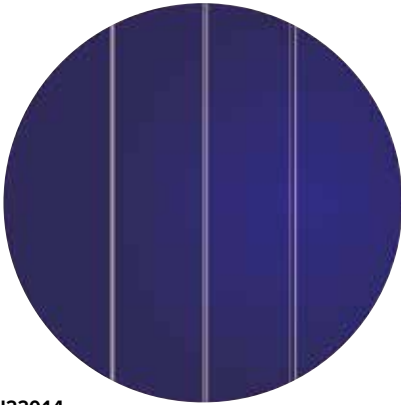

U22014

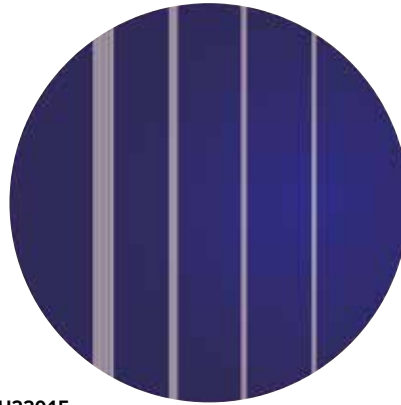

U22015

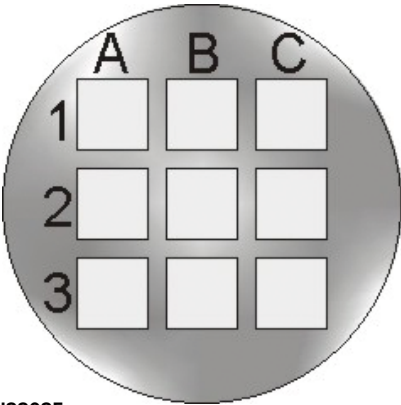

U22025

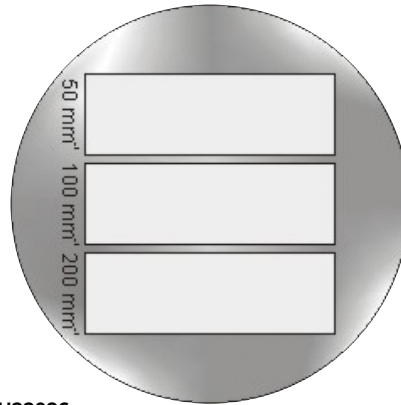

U22026

Microstructures on Glass Plate

Glass plate with nine different microstructures consisting of discs, rectangles and squares for quantitative diffraction experiments.

Diameter:	40 mm
Thickness:	1.5 mm
Disc diameters:	30 μm , 50 μm , 100 μm
Rectangles:	10x50 μm , 20x100 μm , 30x150 μm
Squares:	40x40 μm , 70x70 μm , 120x120 μm

U22025

Diffraction Gratings on Glass Plate

Glass plate with three diffraction gratings of different number of lines for quantitative diffraction experiments.

Diameter:	40 mm
Thickness:	1.5 mm
Surface:	25x7.5 mm each
Number of lines:	50, 100, 200 / mm
Gratings pitch:	20, 10, 5 μm
Precision:	<1 μm

U22026

Diffraction Apertures on Glass Plate

Glass plates with 12 different single and double diffraction apertures for quantitative diffraction experiments.

Diameter of support: 40 mm

Aperture

irregularities: <1 μm

Single apertures:

Diameters: 20, 30, 50, 100, 200 and 500 μm

Double apertures:

Separations: 100, 200 and 400 μm

Diameter: 50 μm

Rectangular

apertures:

Dimensions: 70x70 μm^2 ,
200x200 μm^2 and
70x200 μm^2

U22011

Slits and Bars on Glass Plate

Glass plates with 7 sets of slits and bars of different widths for quantitative diffraction experiments.

Diameter of support: 40 mm

Irregularities: <1 μm

Slit widths: 30, 40, 60, 80, 100, 150 and 200 μm

Bar widths: 30, 40, 60, 80, 100, 150 and 200 μm

U22012

Double Slits on Glass Plate

Glass plates with three double slits of different separations for quantitative diffraction experiments.

Diameter of support: 40 mm

Irregularities: <1 μm

Slit width: 70 μm

Separations: 200, 300 and 500 μm

U22014

Multiple Slits on Glass Plate

Glass plates with four different numbers of multiple slits for quantitative diffraction experiments.

Diameter of support: 40 mm

Irregularities: <1 μm

Slit width: 40 μm

Slit separation: 100 μm

Number of slits: 3, 4, 6 and 14

U22015

U22025

Colour Filters

For fitting on an object holder on a stem (U8474000), in a rotatable object holder on a stem (U17001) or in a clamping holder K (U84755401).



U21878

U21879

Set of 3 Colour Filters, Primary Colours

Set of 3 colour filters, primary colours, in slide frames.

Colours: Red, green, blue
Dimensions: 50x50 mm²

U21878

Set of 3 Colour Filters, Secondary Colours

Set of 3 colour filters, secondary colours, in slide frames.

Colours: Cyan, yellow, magenta
Dimensions: 50x50 mm²

U21879

Set of 7 Colour Filters

Set of 7 colour filters for experiments on additive and subtractive colour combination. Coloured plastic transparencies fitted in slide frame between glass plates.

Primary colours: Red, blue, green
Secondary colours: Cyan, magenta, yellow and violet
Dimensions: 50x50 mm²

U19530



U19530

Interference Filters

Suitable for mounting in the optical component holder (U22010).



U22021

Interference Filters

Narrow frequency-range optical filters for filtering out light of a specific wavelength from a spectrum featuring multiple wavelengths or for making a nearly mono-chromatic light source from a continuous spectrum.

Diameter: 40 mm
Thickness: 3 mm
Precision: 3 nm
Band width (full width half maximum): 10 nm
Transmission: > 60 %
Parasitical transmission: < 1 %

Art. No.	Wavelength	Filtered spectral lines
U22020	436 nm	Blue mercury line
U22019	546 nm	Green mercury line
U22021	578 nm	Yellow mercury doublet

Additionally required:
U22010 Component Holder

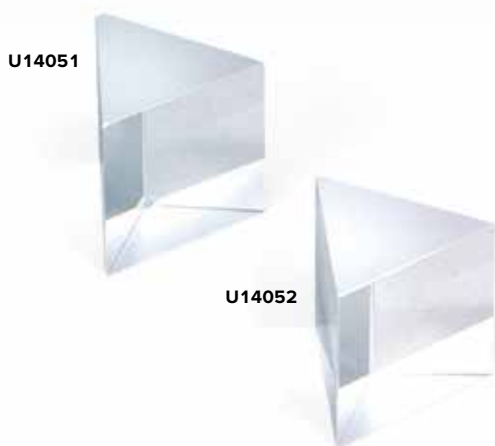

60° Prisms

Equilateral prisms for use on the prism table on shaft (U17020) or prism table K (U8476110).

	U140001	U14005
Material	Crown glass	Crown glass
Refractive index	1.515	1.515
Side length	27 mm	45 mm
Height	50 mm	50 mm

	U14051	U14052
Material	Crown glass	Flint glass
Refractive index	1.515	1.608
Average dispersion	0.008	0.017
Side length	30 mm	30 mm
Height	30 mm	30 mm

90° Prisms

Rectangular prisms for use on the prism table on stem (U17020) or prism table K (U8476110).

	U14010	U14015
Material	Crown glass	Crown glass
Refractive index	1.515	1.515
Side length	30 mm	45 mm
Height	50 mm	50 mm

Set of 3 Prisms

Set of prisms for demonstrating the design of an achromatic prism and a direct vision prism. Consists of a thin flint glass prism, as well as thin and thick crown glass equilateral prisms. The two thin prisms deflect a light beam equally strongly but with different dispersions. Moving them closer together in the light path results in a direct vision prism which decomposes light into its spectral components without deflecting it. The thick crown glass prism has the same dispersion as the flint glass prism, but deflects the light beam twice the distance. This permits configuration of an achromatic prism which deflects light without splitting it into a spectrum.

U14050.....

Material	Flint glass	Crown glass	Crown glass
Refractive index	1.608	1.515	1.515
Average dispersion	0.017	0.008	0.008
Base	15 mm	30 mm	18 mm
Side length	40 mm	40 mm	40 mm
Height	40 mm	40 mm	40 mm

Hollow Prism, Equal-Sided

Equal-sided hollow prism made of optical glass to study diffraction and dispersion of light in liquids. With Teflon stopper on the filling hole.

Length of base: 60 mm_{inside}
 Height: 60 mm_{inside}
 Volume: 89 ml

U11922.....



U11922

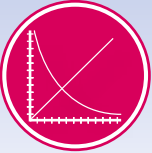
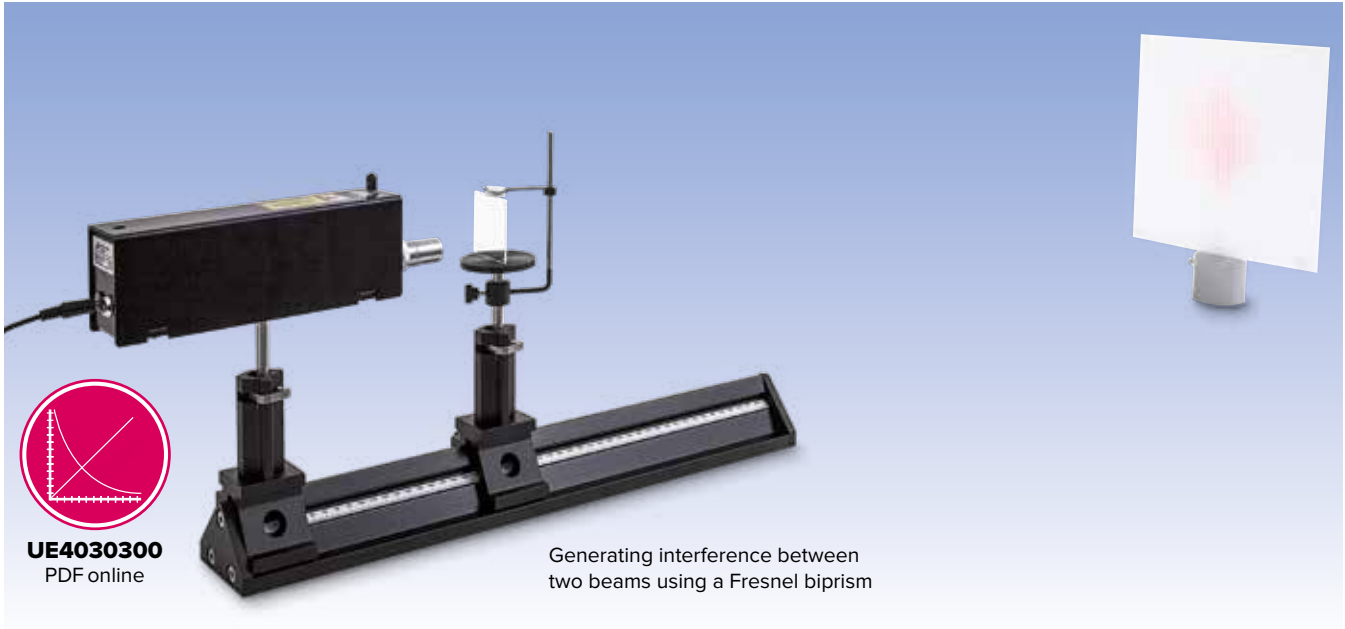

UE4030300
PDF online

Generating interference between two beams using a Fresnel biprism

Fresnel Biprism

Fresnel biprism for observing interference by creating two virtual sources of light by refracting the light from a single coherent source.

Dimensions: 50x50x2 mm³

Prism angle: 179° approx.

Refractive

index: 1.5231

U14053



U14053

Equipment for Fresnel biprism:

U14053 Fresnel Biprism

U17020 Prism Table on Stem

U21840 He-Ne Laser

W30614 Achromatic Objective 10x / 0.25

U17104 Convex Lens on Stem f = +200 mm

U103111 Optical Rider D, 90/50

U10302 Optical Precision Bench D, 50 cm

U17130 Projection Screen

U13265 Barrel Foot, 1000 g

U10073 Pocket Measuring Tape, 2 m

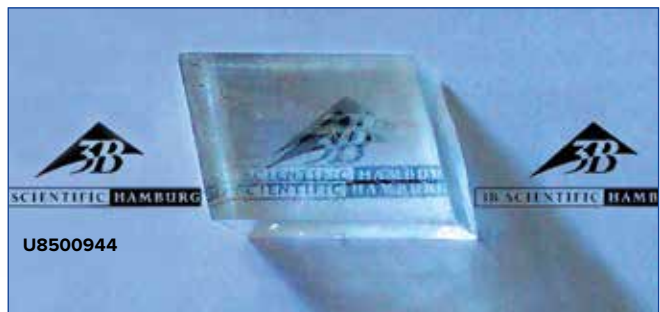

U8500944

Doubly Refracting Crystal

Calcite crystal showing the birefringence in crystals.

U8500944



U8476730

Inverting Spectacles

Spectacles with two fully rotatable inverting prisms in a shielded spectacle frame. The inverting prisms reverse incoming light rays, turning the world upside down, so to speak, and making it unexpectedly difficult for the wearer to perform even the simplest of daily tasks such as reaching for objects, drawing, moving about in a room etc.

U8476730

Amici Direct Vision Prism

A combined prism for splitting light beams into a spectrum without deflecting them. Comprises an alternating combination of two crown glass prisms and one flint glass prism; blackened on the outside.

Dispersion

angle: 4.2°

Dimensions: approx.

105x20x20 mm³

U14020

Additionally recommended:

U8474050 Holder for Direct-Vision Prism on Stem



U14020

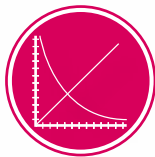

UE404060
PDF online

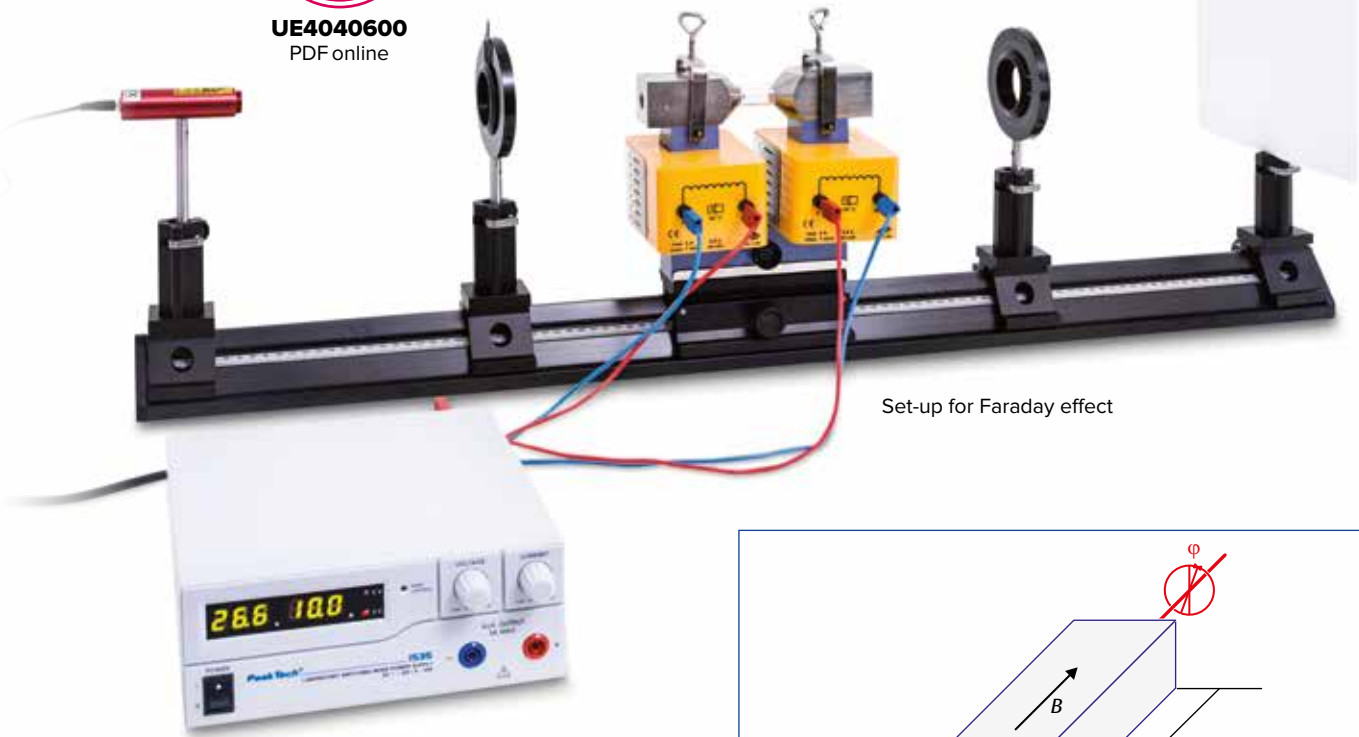

Set-up for Faraday effect

Accessories for Faraday Effect

Three-part set of accessories for holding a flint glass block (U8474060) and a U-shaped transformer core (U8497215) in experiments on the Faraday effect.

U8496420



U8496420

Equipment for Faraday Effect:

U10300 Optical Precision Bench D

U10319 Optical Base D

U8474060 Flint Glass Block for Faraday Effect

U8496420 Accessories for Faraday Effect

U8497215 U Core

U8497200 Pair of Pole Shoes

U8497181 Pair of Clamps

U8497390 Coil D 900 Turns (2x)

U11827-230 DC Power Supply 1 – 32 V, 0 – 20 A (230 V, 50/60 Hz)

or

U11827-115 DC Power Supply 1 – 32 V, 0 – 20 A (115 V, 50/60 Hz)

U138021 Set of 15 Safety Experiment Leads, 75 cm

U22017 Polarisation Filter on Stem (2x)

U103111 Optical Rider D, 90/50 (3x)

Light source with colour filter or laser

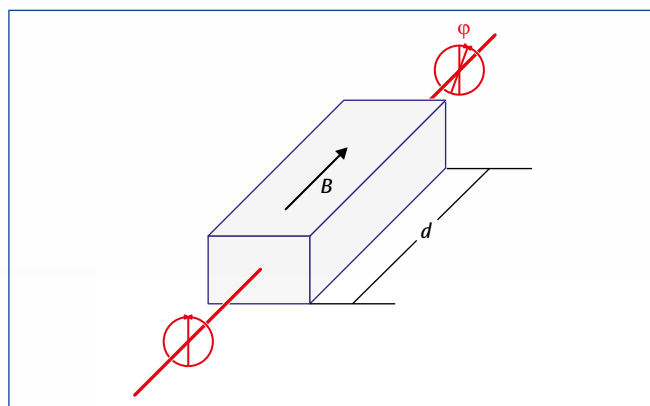

Schematic diagram to illustrate the Faraday effect

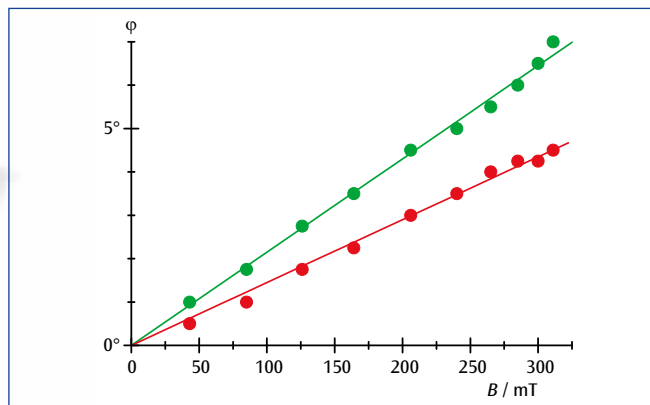

Angle of rotation as a function of the magnetic field for red and green laser light

Flint Glass Block for Faraday Effect

Rectangular block made of flint glass for demonstrating optical activity in a magnetic field (Faraday effect).

Dimensions: 20x10x10 mm³

U8474060



U8474060

Experiment Topics:

- Refraction and interference at the surfaces of a glass block, apertured diaphragm, square diaphragm, grating with slits, cross grating
- Michelson interferometer
- Investigation of linearly polarised light
- Absorption of light
- Reconstruction of a hologram

Equipment Set for Wave Optics with Laser

Equipment set for demonstrating fundamental phenomena in wave optics by means of practical experiments. The light source is provided by a partially polarised diode laser with adjustable mount. Power is supplied from a plug-in power supply (included) or from batteries. The components are magnetic and can be placed horizontally or vertically on the included metal board, according to the set-up required for the various experiments. All components are stored in a case with shaped foam inlay.

Diode laser: max. 1 mW, laser safety class II
 Wavelength: 635 nm
 Plug-in power supply: primary 100 V AC – 240 V AC
 secondary 3 V DC, 300 mA
 Battery holder: for 2x 1.5 V AA batteries
 (batteries not included)

Contents:

- 1 Diode laser with adjustable mounting
- 1 Plug-in power supply
- 1 Battery holder (without batteries)
- 2 Mirrors with adjustable mounting
- 1 Half-silvered mirror
- 1 Screen, white
- 1 Screen, frosted glass
- 1 Convex lens
- 1 Polarisation filter
- 1 Holder for lens and filter
- 3 Colour filters in slide frames (red, green, blue)
- 2 Apertured diaphragms in slide frames
- 2 Square diaphragms in slide frames
- 3 Gratings with slits in slide frames
- 1 Cross grating in slide frame
- 1 Glass plate in slide frame
- 1 Holder for slide frames
- 1 Hologram
- 1 Metal board (60x45 cm²) with removable strut
- 4 Rubber feet for metal board
- 1 Storage case
- 1 Experiment guide

U17303



U17303



Newton's Colour Disc, with Crank

Newton's Colour Disc for demonstrating additive combination of colours. Mounted on a stable base, moved with crank.
 Diameter of disc: 178 mm
 Dimensions of the base: 143x90x282 mm³

U29587



U29587



U29555

Newton's Colour Disc, with DC Motor

Newton's Colour Disc for demonstrating additive combination of colours. Mounted on a stable box, moved by a DC motor.
 Diameter of disc: 90 mm
 Motor: 4 – 6 V DC
 Connection: 4 mm safety sockets
 Dimensions: 135x85x130 mm³

U29555

Additionally required:
U13812 Pair of Safety Experiment Leads, 75 cm
U8521121-230 DC Power Supply 1.5 – 15 V, 1.5 A (230 V, 50/60 Hz)
 or
U8521121-115 DC Power Supply 1.5 – 15 V, 1.5 A (115 V, 50/60 Hz)



U15500

U11040



U11040

Newton's Colour Disc

Plastic, circular disc with segments coloured red, orange, yellow, light green, dark green, light blue, dark blue and violet for demonstrating additive combination of colours. When the disc is turned rapidly, its colours merge to produce white.
 Diameter: 170 mm

U15500

Additionally required:
U11040 Motor with Drive Control



U15500

Motor with Drive Control

Controllable motor for spinning the colour disc fast (U15500). With disc holder and clamp for attachment to a stand rod. Includes plug-in power supply.
 Control range: 0 – 25 rev/s
 Rotation direction: reversible
 Dimensions: approx. 110x70x45 mm³
 Weight: approx. 0.2 kg

U11040

Additionally recommended:
U13270 Tripod Stand, 150 mm
U15002 Stainless Steel Rod, 470 mm

Experiment topics:

- Additive colour mixing
- Subtractive colour mixing

Equipment Set for Colour Mixing

Equipment set for demonstrating how colours combine (with the aid of an overhead projector). This equipment set is designed to permit quick setting up and safe, simple operation. The clear configuration facilitates understanding of the experiments and allows direct viewing of results. The projection plate, along with its three holders for mirrors and lenses, is placed onto the projection surface of the overhead projector. Depending on the projection distance, three large circles with diameters of 30 to 80 cm appear on the projection screen. By turning



U21883

the holders and mirrors, it is possible to project colours so that they are separated or so that they partially overlap. Such adjustments can be performed easily and precisely. The large colour filters can be simply inserted into the lens holders, or placed directly on the overhead projector.

Contents:

- 1 Projection plate with three mirror and lens holders
- 3 Colour filters; red, green, blue (120x50 mm²)
- 3 Colour filters; cyan, yellow, magenta (120x50 mm²)

U21883

Additionally required:

Overhead Projector

Experiment topics:

- The three primary colours
- Creating colours by additive colour mixing
- Components of primary colours in mixed colours
- Colours on a monitor screen
- Principles of perceiving colours (colour triangle)



U11060

“Addition of Colours” School Apparatus

Handy desk-top device for investigating additive mixing of the primary colours, red, green and blue (RGB) to make any other colour. Three adjustment mechanisms allow any intensity of each primary colour to be selected so that various components of LED light can be mixed and observed with the help of a frosted glass screen. Includes 12 V/500 mA plug-in power supply and instruction manual for a colour triangle.

Dimensions: 192x65x120 mm³

U11060

Advantages

- **Plug & play: no software installation or drivers required**
- **Measurement and evaluation in real-time**
- **Simple and practical software with built-in wizards and powerful evaluation function**
- **Spectra of high quality and signal stability**
- **Low noise**
- **High resolution**
- **Suitable for measuring very slight fluctuations in intensity with very high precision.**
- **Measurement of second-order diffraction without saturation of the first order**

CCD HD Sensor

Optical sensor for investigating distribution of light intensity. Particularly well suited for the investigation of light diffraction at single slits, multiple slits or diffraction gratings. User-friendly measurement and evaluation software enable simultaneous recording and analysis in real-time. The built-in software for Windows 2000/XP/Vista/7/8 32- and 64-bit versions starts running as soon as the sensor is connected to the computer via a USB cable. Includes attenuating filter, stand rod and plug-in power supply.

Software:

Data acquisition possible in two modes:
 Intensity as a function of location, e.g. for diffraction and interference.
 Intensity in a region as a function of time.
 Pointer mode, model calculation mode, spreadsheet and report modes are all available for the purposes of evaluation.

Sensor: Toshiba 3648 pixel SWB
 Resolution: 16 bits
 Integration time: 0.1 ms to 6.5 s
 Filter attachment: Clix (magnetic ring)
 Sensitive surface of sensor: 8 µm x 30 mm
 Interface: USB 2.0

U22058

Experiment Topics:

- Measurement and calculations for models of diffraction at a single slit, multiple slit and diffraction gratings.
- Interference
- Fluctuations in intensity

Additionally recommended:

- U22000 Laser Diode, Red**
- U22010 Component Holder**
- U22011 Diffraction Apertures on Glass Plate**
- U22012 Slits and Bars on Glass Plate**
- U22014 Double Slits on Glass Plate**
- U22015 Multiple Slits on Glass Plate**
- U10300 Optical bench**
- U103111 Optical rider (3x)**



Experiment Topics:

- Pockels effect (linear electro-optic effect)
- Photorefractive crystal with no inversion centre
- Occurrence and modification of double refraction in external electric fields
- Half-wave voltage
- Modulation of refractive index

Advantage

- With accurate, free-moving and smooth angle adjustment



U8557250

new

Pockels Cell on Stem

Transverse Pockels cell for demonstrating linear electro-optic effect and measuring half-wave voltage of a lithium niobate crystal. With accurate, free-moving and smooth angle adjustment for demonstrating double refraction in conjunction with a polarisation filter used as an analyser.

Dimensions: 156x26x218 mm³
 Weight: 206 g
 Crystal: Lithium niobate (LiNbO₃), 20x2x2 mm
 Connectors: 4-mm safety sockets

U8557250

Additionally recommended:

- U10300 Optical Precision Bench D P-1000 mm
- U103111 Optical Rider D, 90/50 (3 x)
- U103161 Optical Rider D, 90/36 (2x)
- U22017 Polarisation Filter on Stem
- U17130 Projection Screen
- U21840 He-Ne Laser
- W30614 Achromatic Objective 10x / 0.25
- U17101 Convex Lens on Stem f =+50 mm
- U8498294-230 High Voltage Power Supply E 5 kV (230 V, 50/60 Hz)

or

- U8498294-115 High Voltage Power Supply E 5 kV (115 V, 50/60 Hz)
- U13812 Pair of Safety Experiment Leads, 75 cm

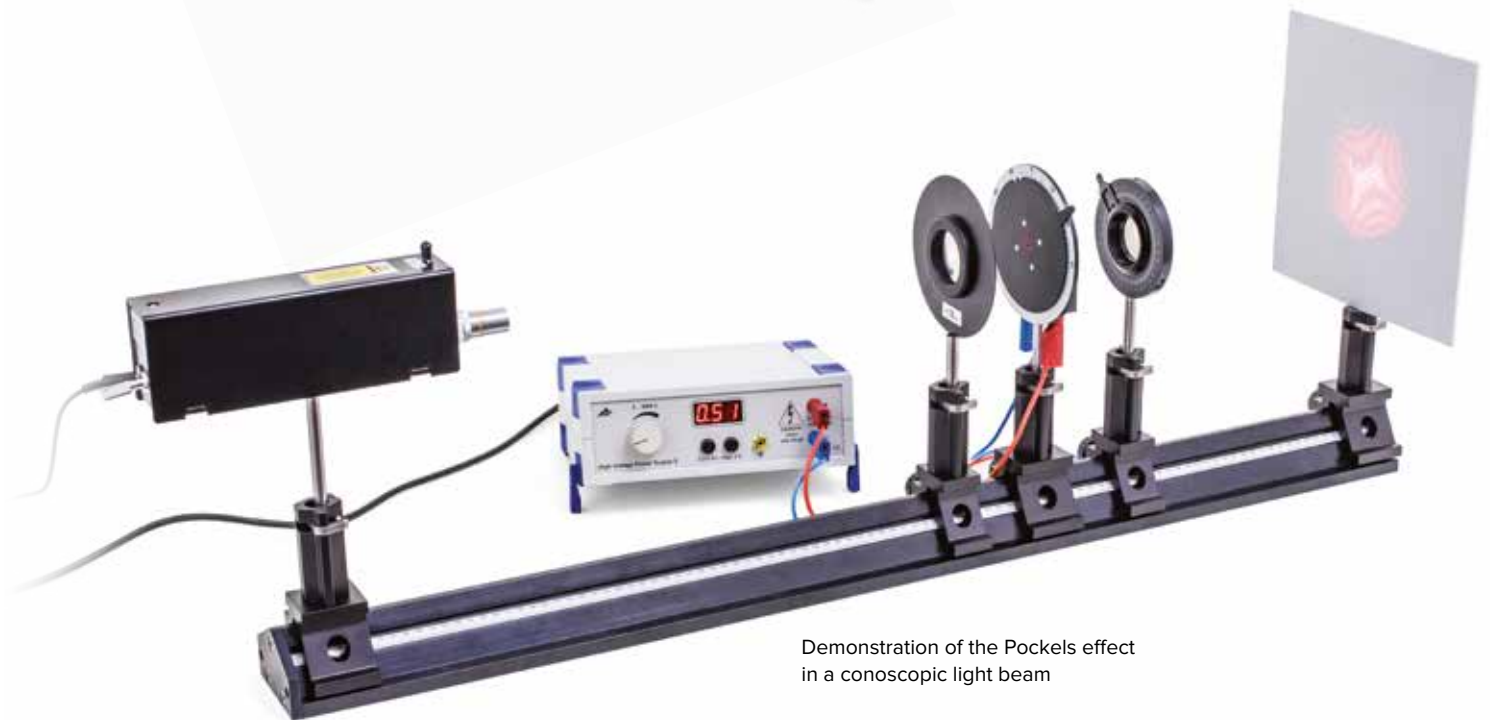

Demonstration of the Pockels effect in a conoscopic light beam



U14390

Demonstration Polarimeter

Device for use on an overhead projector to demonstrate optical activity and determine specific angles of rotation and concentrations at known specific angles of rotation. A yellow filter (for more precise measurement accuracy) and a polariser are embedded in a black plastic base plate. A cell containing a solution of the substance to be investigated with 50 mm and 100 mm markings is inserted into the holder. The analyzer is situated above this set-up in a holder with rotary handle and pointer. By turning the analyser, it is possible to ascertain the angle of rotation and read it off a transparent angle scale.

Cuvette: Markings at 50 mm and 100 mm
 Angle scale: -40° – $+40^\circ$
 Scale divisions: 1°
 Dimensions: approx. 370x330x190 mm³

U14390

Additionally required:
Overhead Projector

Demonstration Polariscopes

Apparatus for use on an overhead projector to demonstrate a photo-elastic image in samples subjected to stress and strain. The polarising filter is incorporated into the base plate of the frame; the analyser is embedded in the laterally swivelling upper base plate. Via the spindle drive, a tensile or pressure load can be exerted on the test body.

Samples: Epoxy-resin
 Dimensions: approx. 150x150x45 mm³
 Total weight: approx. 820 g

Contents:

- 1 Basic apparatus
- 2 Metal clamps for applying tension
- 1 Ring, 60 mm diam.
- 1 Block, 60x10x10 mm³
- 2 Blocks, 20x10x8 mm³
- 3 Triangles to lay on surface

U8472580

Additionally required:
Overhead Projector

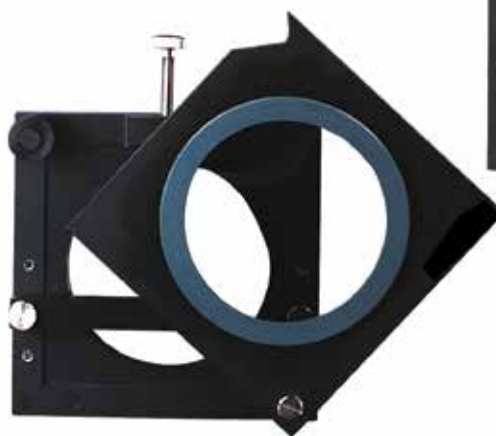

U8472580

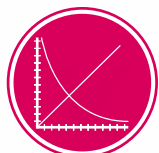
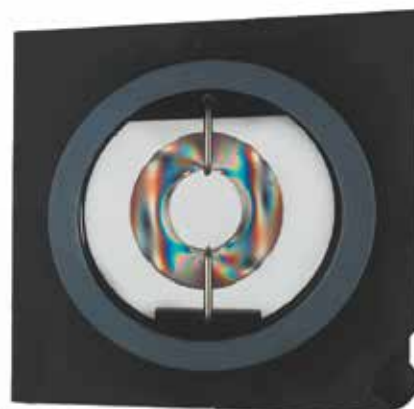

UE4040300
 PDF online



U8761161-230

Polarimeter with 4 LEDs

Polarimeter with a lighting unit comprising four monochromatic LEDs for determining the angle and direction of rotation of polarised light as a function of wavelength as well as sample thickness and concentration with the help of an optically active substance. The light emerging from those LEDs that are lit is polarised linearly and transmitted through a fitted sample cylinder filled with the optically active substance. The analyser in the cover is used to identify the direction of polarisation which can be read on the cover's angle scale.

Wavelength of LEDs: 468 nm (blue), 525 nm (green),
 580 nm (yellow), 630 nm (red)
 Dimensions: approx. 110x190x320 mm³
 Weight: approx. 1 kg

U8761161-230

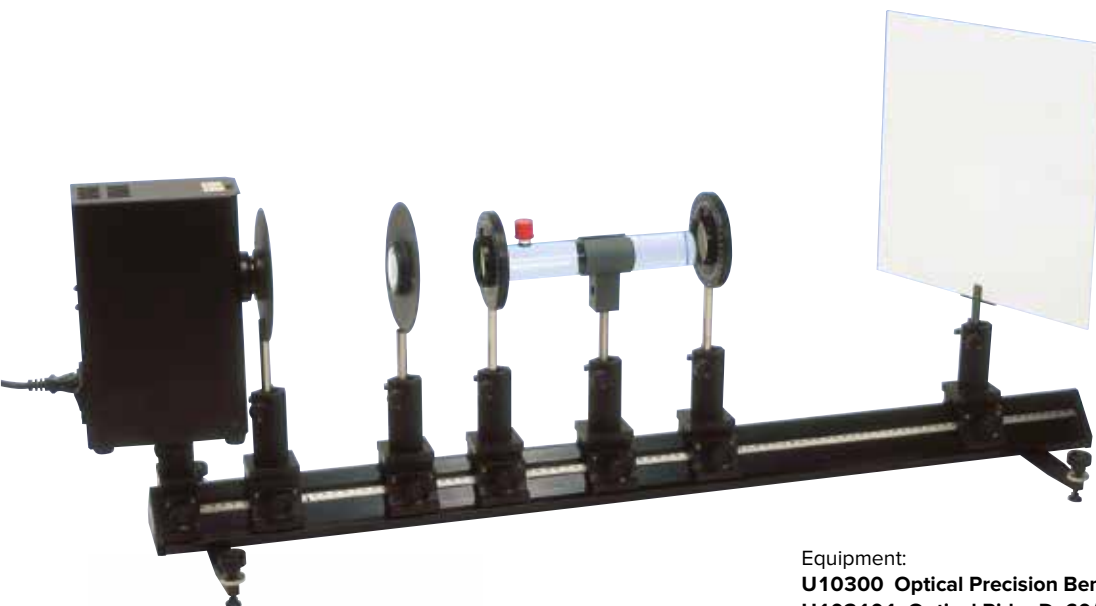

Determination of the angle of rotation of optically active substances



- Equipment:
- U10300** Optical Precision Bench D, 1000 mm
 - U103101** Optical Rider D, 60/50 (2x)
 - U103111** Optical Rider D, 90/50 (5x)
 - U11112** Cell Holder on Stem
 - U14313** Round Cell, 200 mm
 - U14314** Round Cell, 100 mm
 - U17010** Iris Diaphragm on Stem
 - U17101** Convex Lens on Stem, $f = 50$ mm
 - U17130** Projection Screen
 - U22017** Polarisation Filter on Stem (2x)
 - U21829-230** Na Low-Pressure Spectral Lamp (230 V, 50/60 Hz)

Round Cells

Duran glass cells with bonded optical discs and GL threads. E.g. for experiments on the determination of the angle of rotation of optically active substances on the optical bench.

Diameter: 35 mm
Thread: GL-14

Round Cell, 100 mm

U14313

Round Cell, 200 mm

U14314

Cell Holder on Stem

Plastic holder for round cells (U14313) and (U14314).

Holder: 36 mm diam.

Stem: 90 mm x 10 mm diam.

U11112

Polarimeter

Polarimeter with a sodium lamp as the light source for the measurement of the rotation and the rotation direction of the polarisation plane of polarised light through optically active substances as well as the determination of the concentration of liquids. Robust metal stand with slightly tilted shaft for tubes with lengths up to 220 mm. With swivel cover, analyser and polariser. A sodium lamp with filter holder is used as a light source. Includes polarimeter tubes 100 mm, 200 mm and spare sodium lamp.

Measurement range: 2 semi-circles (0 – 180°)

Glass tubes: 100 and 200 mm, 15 mm diam.

Scale division: 1°

Readability: 0.05° (with Vernier scale)

Dimensions: 200x360x450 mm³

Weight: approx. 10 kg

Light source: Sodium lamp (589 nm)

Mains voltage: 115 V – 230 V, 50/60 Hz

U33400

Spare Sodium Lamp (not shown)

Spare lamp for polarimeter (U33400).

U33403



Polarimeter Tube 100 mm

(not shown)

Spare glass tube for polarimeter (U33400).

Length: 100 mm, 15 mm diam.

U33401

Polarimeter Tube 200 mm

(not shown)

Spare glass tube for polarimeter (U33400).

Length: 200 mm, 15 mm diam.

U33402

Control Unit for Spectrum Lamps

Control unit for operating spectral lamps (U8476800 – U8476875), including a lamp housing on a stand rod. A second lamp housing on a stand rod can be clamped to the rear side of the stable metal housing and connected to the electricity supply. A switch on the front can be used to change over between the right-hand and left-hand spectral lamps.

Maximum output current: 1 A

Lamp housing: 180 mm x 50 mm diam.
 Tripod rod: 300 mm x 10 mm diam.
 Lamp socket: Pico 9
 Dimensions: approx. 255x175x135 mm³
 Weight: approx. 5.3 kg

Contents:

1 Control unit
 1 Lamp housing on a stand rod with a 7-pole connection cable

Control Unit for Spectrum Lamps (230 V, 50/60 Hz)

U21905-230

Control Unit for Spectrum Lamps (115 V, 50/60 Hz)

U21905-115

Additionally recommended:

U21906 Lamp Housing on a Stand Rod

Lamp Housing on a Stand Rod (not shown)

Additional lamp housing with a cable for connecting to a spectral lamp ballast coil (U21905-230 resp. U21905-115).

U21906

Spectrum Tube Power Supply

Control unit for stable operation of spectral tubes (U41810 – U41825). The integrated current limiter ensures a long service life of the tubes. Spring-contacts in fully insulated fixtures and a protective window guarantee secure mounting and reliable operation.

Voltage: 5000 V
 Maximum current: 10 mA
 Dimensions: approx. 370x120x90 mm³

Spectrum Tube Power Supply (230 V, 50/60 Hz)

U418001-230

Spectrum Tube Power Supply (115 V, 50/60 Hz)

U418001-115

Spectrum Tubes

High luminance spectral tubes emitting the line or band spectrum of a gas or mercury vapour. Partly evacuated capillary glass tubes filled with gas or mercury vapour are furnished with electrodes for the application of a voltage to generate the electrical field that provides the necessary energy.

Capillary length: 100 mm
 Total length: approx. 260 mm

Spectral Lamps

Gas discharge lamps for emitting line spectra of inert gases and metal vapours with high luminance and spectral purity.

Socket: Pico 9
 Operating current: max. 1A
 Weight: approx. 350 g

Spectral lamps may only be operated with the control unit for spectral lamps (U21905-230 or U21905-115).

Additionally required:

U21905-230 Control Unit for Spectrum Lamps (230 V, 50/60 Hz) or

U21905-115 Control Unit for Spectrum Lamps (115 V, 50/60 Hz)



**U8476800/
U8476875**

Art. No.	Filling
U8476800	Cd
U8476810	He
U8476840	Na
U8476850	Ne
U8476855	Tl
U8476870	Hg 100
U8476875	Hg/Cd



**U21905-230
U21905-115**

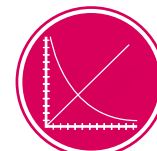

UE5020150
PDF online



**U418001-230
U418001-115**

Additionally required:

U418001-230 Spectrum Tube Power Supply (230 V, 50/60 Hz) or

U418001-115 Spectrum Tube Power Supply (115 V, 50/60 Hz)

Art. No.	Filling
U41810	Air
U41811	Argon
U41812	Bromine
U41813	Carbon dioxide
U41814	Chlorine
U41815	Deuterium
U41816	Helium
U41817	Hydrogen
U41818	Iodine
U41819	Krypton
U41820	Mercury
U41821	Neon
U41822	Nitrogen
U41823	Oxygen
U41824	Water vapor
U41825	Xenon

Recording the
line spectrum of
hydrogen



U418001-230

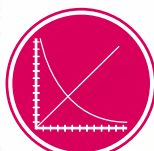

UE5020100
PDF online

U22028

High-Pressure Mercury Spectral Lamp (230 V, 50/60 Hz)

Gas discharge lamp for observing high-intensity mercury spectral lines at high vapour pressures. Lines in the ultra-violet range are suppressed by the glass body. Includes a black metal housing with integrated power supply unit, a light aperture with a fine thread for direct screw-mounting of filters and a threaded stand rod.

Luminance: 1800 lm
 Operating current: 0.6 A
 Power: 50 W
 Base: E27
 Service life: approx. 24000 h
 Threaded light aperture: 40 mm diam.
 Fine thread for filter: M49
 Dimensions: approx. 295x165x85 mm³
 Weight: approx. 1.5 kg

U21827-230

Low-Pressure Mercury Spectral Lamp (230 V, 50/60 Hz)

Gas discharge lamp for observing mercury spectral lines at low vapour pressures with optimal line widths. The body is made of quartz glass to allow detection of lines in the ultra-violet range too. Includes a black metal housing with integrated power supply unit, a light aperture with a fine thread for direct screw-mounting of filters and a threaded stand rod.

Operating current: 0.16 A
 Power: 6 W
 Base: G5
 Service life: approx. 3000 h
 Threaded light aperture: 40 mm diam.
 Fine thread for filter: M49
 Dimensions: approx. 295x165x85 mm³
 Weight: approx. 1.5 kg

U21828-230

Low-Pressure Sodium Spectral Lamp (230 V, 50/60 Hz)

Gas discharge lamp for observing Na D lines and investigating of the doublet. Includes a black metal housing with integrated power supply unit, a light aperture with a fine thread for direct screw-mounting of filters and a threaded stand rod.

Luminance: 1800 lm
 Operating current: 0.35 A
 Power: 18 W
 Base: BY22d
 Service life: approx. 10000 h
 Threaded light aperture: 40 mm diam.
 Fine thread for filter: M49
 Dimensions: approx. 295x165x85 mm³
 Weight: approx. 1.5 kg

U21829-230

Spare Lamps: (not shown)

Art. No.	Description
U21831-230	Hg High-Pressure Spectral Lamp for U21827-230
U21832-230	Hg Low-Pressure Spectral Lamp for U21828-230
U21833-230	Na Low-Pressure Spectral Lamp for U21829-230



U21828-230

U21827-230

U21829-230

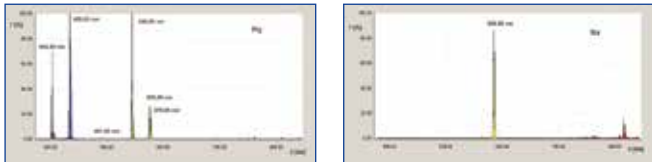

Line spectra of Hg (high-pressure) and Na, recorded using the digital spectrometer

High-Pressure Mercury Vapour Lamp

High-pressure mercury vapour lamp in hardened glass bulb made of blackened borosilicate glass, with tube-shaped hole allowing emission of unfiltered ultra-violet radiation. Includes E27 lamp holder on stem and see-through screen to protect users from UV radiation.

Wavelength ranges: UV-A, UV-B, UV-C
 Power consumption: 125 W

U8473155

Additionally required:

U21905-230 Control Unit for Spectrum Lamps (230 V, 50/60 Hz)

or

U21905-115 Control Unit for Spectrum Lamps (115 V, 50/60 Hz)



U8473155

U21905-230
U21905-115

Handheld Spectroscope

Device for observing absorption and emission spectra, e.g. to observe the Fraunhofer line spectrum in sunlight for the observation of absorption spectra through liquids, the emission spectra of gas discharge tubes or for chemical analysis during flame tests.

Spectroscope in Cardboard Box

Hand spectroscope in a flat cardboard box with printed wavelength scale for easy reading of spectral lines and spectra.

Dimensions: approx. 180x115x25 mm³

U21876



U21876

Spectroscope in Metal Case

Hand spectroscope in a flat metal case with printed wavelength scale for easy reading of spectral lines and spectra. With holder for mounting a probe in a plastic vessel.

Dimensions: approx. 180x115x25 mm³

U21877

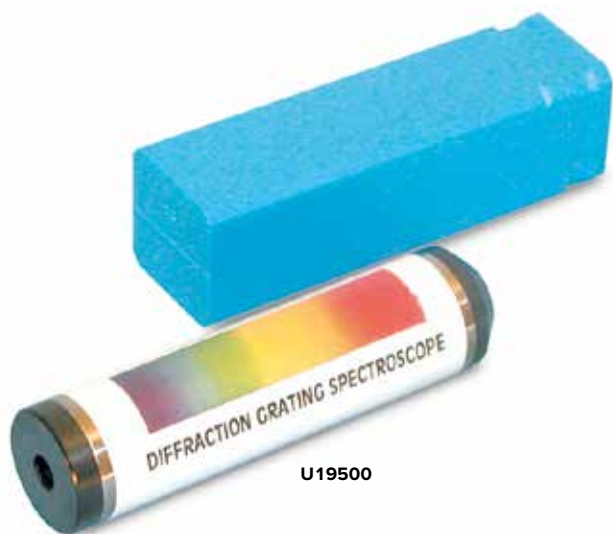

U19500

Pocket Spectroscope

High quality optical system with centered visible spectrum, which is linear with respect to the wavelength. In metal sleeve. With fixed slit and prism system with grating

Slit width: 0.2 mm

Number of grating lines: 600 lines/mm

Dimensions: approx. 115 mm x 25 mm diam.

Weight: approx. 62 g

U19500



U21877

Hand Spectroscope with an Amici Prism

Precise optical system with a visible spectrum that is linear in terms of wavelength around the centre point. In a metal housing with an adjustable slit and high-grade Amici prism. Delivery in hinged case for protective and dust-free storage.

Angular dispersion: 7° (C-F)

Linear dispersion: 60 mm

Slit width: 0 – 1 mm

Folding case: approx. 150x70x30 mm³

Weight: approx. 150 g

U8472660



U8472660

Spectrometer-Goniometer

Spectrometer with rotatable prism and directionally-adjustable objective tube for observing and measuring emission and absorption spectra. Can also be used for precise determination of the optical parameters of prisms. Includes prism with mounting and a holder for transmission gratings.

- Objective tube: Symmetrical precision slit of hardened steel; adjustable slit width, slit height and distance; $f = 160$ mm, 18 mm diam.
- Eyeiece tube: Continuous focusing and viewing angle adjustment, eyepiece with cross-wire, $f = 160$ mm, 18 mm diam.
- Prism: flint glass (60°)
 - Dispersion ($n_F - n_C$): 0.017
 - Base length: 33 mm
 - Height: 22 mm
- Angular scale: 0° to 360°
 - Scale divisions: 0.5°
 - Reading precision: $1'$ (Vernier scale with magnifying lens)
- Height: 250 mm approx.
- Weight: 8 kg approx.



U14416

U14416



U14415

Kirchhoff-Bunsen Spectroscope

Desktop spectroscope for the observation and measurement of emission and absorption spectra. With adjustable slit, condensor, flint glass prism as well as an observation telescope with sliding ocular. Scale tube with reference division, which is superimposed on the image plane of the spectrum due to reflection at the front surface of the prism. Includes removable prism hood. Ideal for schools and universities.

- Observation tube: moveable, with locking screw, slideable eyepiece
- Objective: $f = 160$ mm, 18 mm diam.
- Slit tube: stationary, with symmetrical slit
- Objective: $f = 160$ mm, 18 mm diam.
- Scale tube: stationary, 200-division scale
- Eyeiece: $f = 90$ mm, 18 mm diam.
- Scale: can be calibrated in wavelengths
- Prism: Flint glass (60°), Dispersion ($n_F - n_C$): 0.017
- Length of base: 20 mm, height: 30 mm
- Weight: 4.8 kg

U14415

S-system Spectrometer-Goniometer

Spectrometer with rotatable prism or grating and directionally-adjustable objective tube for observing and measuring emission and absorption spectra. Can also be used for precise determination of the optical parameters of prisms or gratings. Includes prism with holder and transmission grating with holder.

- Objective tube: Adjustable slit width and object distance; $f = 175$ mm, 32 mm diam.
- Eyeiece tube: Continuous focusing and viewing angle adjustment, eyepiece with cross-wire, $f = 175$ mm, 32 mm diam.
- Prism: flint glass (60°)
 - Dispersion ($n_F - n_C$): 0.017
 - Base length: 40 mm
 - Height: 40 mm
- Transmission grating: 300 lines/mm
- Angular scale: 0° to 360°
 - Scale divisions: 0.5°
 - Reading precision: $0.5'$ (Vernier scale)
- Height: 250 mm
- Weight: approx. 12 kg

U22050



U22050

Advantages

- **Plug & play: no software installation or drivers required**
- **Connect up your spectrometer and the spectrum is obtained immediately**
- **Measurement and evaluation in real-time**
- **Simple and practical software with built-in wizards and powerful evaluation functions**
- **Internal memory for measured data**
- **Spectra of high quality and signal stability**
- **Highly stable metal casing with built-in entry slit**
- **Internal beam paths and the principle of operation can be viewed by opening the lid of the casing**

Digital Spectrometer

Digital spectrometer for quantitative analysis of emission and absorption spectra, for recording transmission curves and performing measurements in calorimetry and kinetics. Incident light from a fibre-optic cable is dispersed into a spectrum by a Czerny-Turner monochromator and projected from there onto a CCD detector. The entry slit is built into the casing. User-friendly measurement and evaluation software enable simultaneous recording and analysis in real-time. The built-in software for Windows 2000/XP/Vista/7/8 32- and 64-bit versions starts running as soon as the sensor is connected to the computer via a USB cable. Includes plug-in power supply and holder for fibre-optic cable.

CCD detector:	3600 pixels
Resolution:	16 bit
Integration time:	0.1 to 60 s
Entry slit:	40 μm metal
Interface:	USB 2.0
Connectors:	SMA 905
Fibre-optic cable:	2 m
Mains voltage:	100 – 240 V
Dimensions:	133x120x60 mm ³
Weight:	950 g

Digital Spectrometer HD

Grating:	1200 lines/mm
Spectral range:	400 – 700 nm
Spectral resolution:	0.5 nm (for resolution of sodium doublet)
Accuracy:	1 pixel per 0.08 nm

U22029

Experiment Topics:

- Line spectra, continuous spectra
- Black-body radiators, Wien's law
- Emission spectrum of sodium
- Flame spectra
- Transmission spectra of solid bodies and liquids
- Kinetics
- Beer-Lambert law

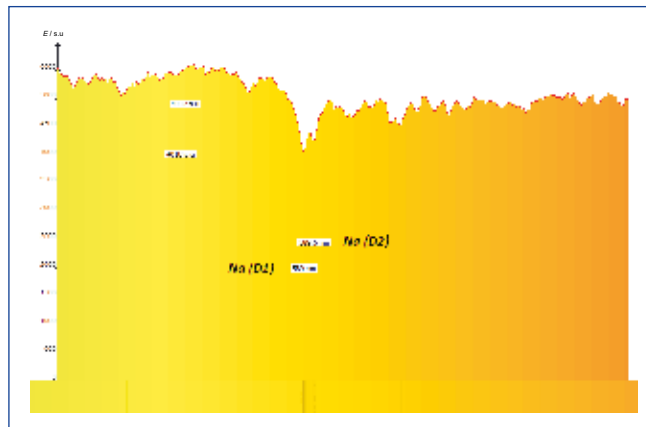

Sodium absorption lines in the spectrum of the sun (resolution of sodium doublet), observed using digital spectrometer HD.

Digital Spectrometer LD

Grating:	600 lines/mm
Spectral range:	350 – 900 nm
Spectral resolution:	1 nm (for resolution of mercury doublet)
Accuracy:	1 pixel per 0.15 nm

U22028

Digital Spectrometer LD with Absorption Chamber (p. 181)

U22031

Additionally recommended:

U10160 Set of 100 Cuvette Cells, 4 ml



Digital Spectrometer LD with Absorption Chamber

Multi-functional module for recording transmission or absorption measurements using 4-ml cells (10x10x40 mm), objects in slide format (50x50 mm) or objects in coin format (40 mm diam.). Up to two slide-format objects and one coin-format object can be analysed simultaneously and compared. With built-in light source for the spectral region from 350 – 1000 nm. In metal casing resistant to chemicals. For direct connection to digital spectrometers LD via fibre-optic cable.

Light source: 350 – 1000 nm
 Power supply: 12 V (via adaptor cable from plug-in power supply for digital spectrometer)
 Dimensions: 65x100x55 mm³
 Weight: 250 g

U22031

Additionally recommended:
U10160 Set of 100 Cuvette Cells, 4 ml



Set of 100 Cuvette Cells, 4 ml (not shown)

Set of 100 disposable cuvette cells for use in absorption chamber for digital spectrometers LD (U22031).

Dimensions: 10x10x40 mm³

U10160

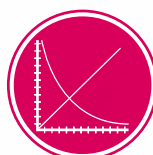

UE4020400
 PDF online

Recording the transmission spectra of colour filters.



Spectrophotometer S

Robust spectrometer for investigating the near infra-red and infra-red regions of the spectrum between 360 and 800 nm. Its removable covers allow students to see first hand the spectrum analysis process. Setup is quick and easy. The optical signal enters the device through a flexible fibre optic cable. Connection to a PC is via the USB 2.0 interface. A specially selected transmission grating and precision slit gives high resolution and excellent results. Data collection software is intuitive with real time graphical output. For easier interpretation of the spectrum, each wave band is shaded with the corresponding colour. The spectrum can be viewed either as a graph or in text form, which allows for more advanced calculations. The availability of several toolbars makes it possible to set the spectrometer parameters to exactly fit the requirements of the experiment. Spectrometer S is supplied ready to use; tested and calibrated.

Spectral range: 360 – 800 nm
 Spectrometer resolution: < 2.0 nm
 Pixel resolution: < 0.5 nm
 Operating system: Win XP, Vista, Win7
 Interface: USB 2.0
 Dimensions: 60x60x120 mm³
 Weight: 600 g

Contents:

Spectrophotometer S with USB cable, fibre optic cable, and a CD containing experimental software and an instruction manual. Laptop not included.

U17310



Experiment topics:

- Mach-Zehnder interferometer
- Changes in polarisation at beam splitter and mirror surface
- Demonstration analogous with quantum eraser experiment
- Determination of the refractive index of glass*
- Determination of the refractive index of air*
- Twyman-Green test for optical components (qualitative)*

* Accessory set (U10351) required

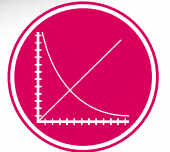

UE4030520
PDF online

Mach-Zehnder Interferometer

Complete equipment set consisting of two beam splitters, two surface-coated mirrors, two observation screens and four polarisation filters. The high-grade optical components mounted on a heavy, rigid base plate for precise and reproducible measurements. Beyond the first beam splitter, the two parts of the split beam take different paths to the second beam splitter, where they are once again superimposed. This means that by adding in polarisation filters, it is possible for the two beams to be differently polarised. The large optical components permit a generation of clear and well-defined interference patterns, which can even be viewed in daylight as the tilt of the two reflecting observation screens can be adjusted. Pre-defined component positions allow quick rearrangement to ensure extremely rapid preparation for the various experiments. The equipment set includes a stable plastic box for storing the mounted and adjusted interferometer as well as the base plate for laser.

Beam splitter:

Diameter: 40 mm
Evenness: $\lambda/10$ (front side), $\lambda/4$ (rear side)

Surface-coated mirror:

Dimensions 40x40 mm²
Evenness: $<\lambda/2$

Polarisation filter:

Diameter: 30 mm
Adjustable range: $\pm 105^\circ$
Material: Glass (2x), foil (2x)
Angular graduation: $3^\circ, 15^\circ$

Base plate:

Weight: 5.5 kg
Dimensions: 245x330x25 mm³

U10353

Additionally required:

U21840 He-Ne-Laser

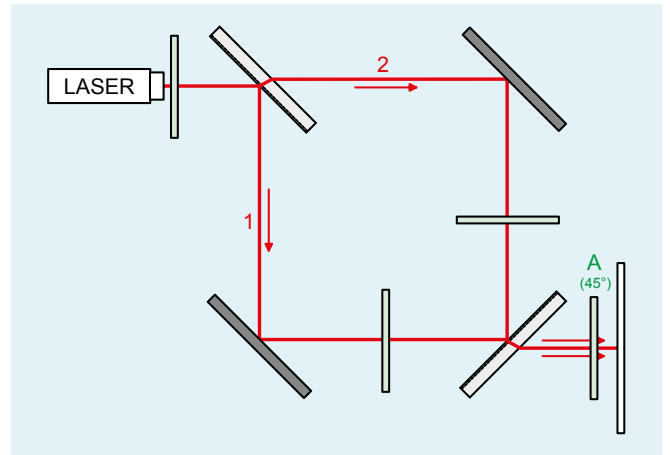

Paths through the Mach-Zehnder interferometer (polariser A “erases” the path information)



Optical Lamp with Pinhole Aperture

High quality source of white light with a pinhole aperture fitting which can be rotated and latches into position. Includes matching base for use with Mach-Zehnder or Michelson interferometers.

Light source: LED, 2x2 mm² light-emitting surface
Light intensity: 289 lumen
Pinholes: 0.5/0.7/1.0/1.4/2.0/2.8/4.0/5.7/8.0/16 mm

U10354

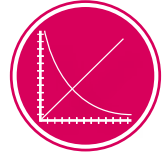

UE4030410
PDF online

Experiment topics:

- Michelson Interferometer
- Fabry-Perot Interferometer
- Determination of the refractive index of glass*
- Determination of the refractive index of air*
- Twyman-Green test for optical components (qualitative)*

* Accessory set (U10351) required



U10350



Interferometers

Interferometer

This complete equipment set comprises high grade optical components mounted on a heavy, rigid base plate for precise and reproducible measurements. The large optical components permit a generation of clear and well defined interference patterns in daylight. The reflective observation screen has an adjustable inclination. Pre-defined component positions allow quick rearrangement to ensure extremely rapid preparation for the various experiments. The equipment set includes a stable plastic box for storing the mounted and adjusted interferometer as well as the base plate for laser.

Beam splitter:

Diameter: 40 mm
Evenness: $\lambda/10$ (front side), $\lambda/4$ (rear side)

Surface-coated mirror:

Dimensions 40x40 mm²
Evenness: $<\lambda/2$

Accessory Set for the Interferometer

This accessory set for the interferometer (U10350) consists of a vacuum cell for determining the refractive index of air and a glass plate on a rotatable holder for determining the refractive index of glass and investigating the surface quality of optical components (Twyman-Green interferometer).

U10351

Additionally required:
U205001 Vacuum Hand Pump
U10146 Silicone Tube

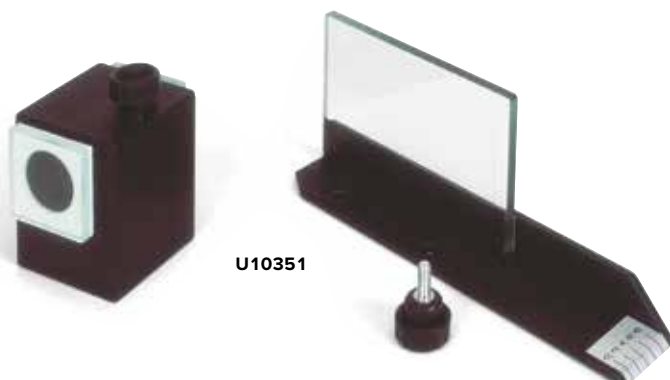

U10351

Mirror adjustment:

Eccentric reduction: approx. 1:1000 (individual calibration specified on eccentric base)

Base plate:

Weight: 5.5 kg
Dimensions: 245x330x25 mm³

U10350

Additionally required:
U21840 He-Ne Laser



Glass plate in the beam path of the Michelson interferometer

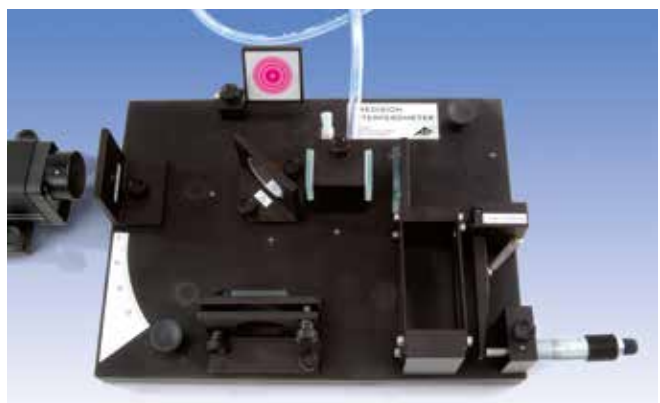

Vacuum chamber in the beam path of the Michelson interferometer

Light and Optics

Advantages

- Precise, safe and inexpensive solution for the operation of continuous wave (cw) and pulsed diode lasers.
- Precise current-controlled continuous wave and pulse-type laser driver
- Two TEC (Thermo Electric Cooler) drivers with PID controllers
- Digital and analogue modulation inputs

- Multiple safety circuits
- Stored configuration (EEPROM)
- Very low power dissipation due to bias voltage control in cw-mode
- Digital control using isolated RS232 serial interface

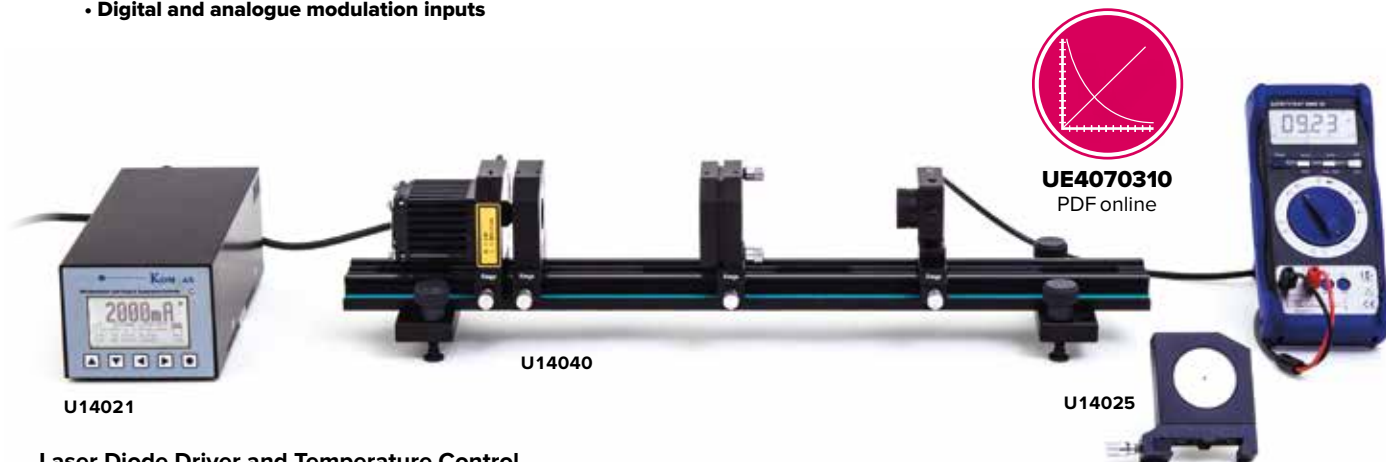

UE4070310
PDF online

Laser Diode Driver and Temperature Control

Power supply for current-stabilised control of laser diode using control unit to control the power of the optical beam from the laser diode in cw mode by means of the built-in photodiode input. In pulsed mode the laser diode can be operated with the freely configurable built-in oscillator or externally using the modulation input. The temperature controllers are designed as PID controllers and configured for standard operation with NTC and Pt100 sensors. The use of silicon temperature sensors or other types is equally possible simply by altering the software configuration.

U14021

Laser:

Laser current range:	0 – 2500 mA
Laser current resolution:	1 mA
Laser current accuracy:	<1 mA
Laser current noise:	<60 μ s
Pulse rise time:	<10 μ s
Pulse fall time:	<5 μ s
Voltage range:	1.2 – 5 V
Current limit:	adjustable between 0 – 2500 mA
External digital modulation input:	TTL

TEC Driver:

Peltier current:	max. -4 – +4 A
Peltier current (2nd driver):	max. -2 – +2 A
Peltier voltage:	max. 8 V
Peltier current limit:	adjustable between 0 – 4 A
Peltier current limit (2nd driver):	adjustable between 0 – 2 A
Peltier current resolution:	1 mA
Temperature control accuracy:	<10 mK

General specs:

Over-temperature protection:	for driver and laser
Mains voltage:	100 up to 240 V AC
Dimensions:	88x110x240 mm ³

Optical Bench KL

Profile rail with levelling platform, 600 mm.

U14040

Nd:YAG-Module

Module with Nd:YAG crystal to act as an active laser medium with dielectrically coated surface for reflecting the laser wavelength (1064 nm) during simultaneous transmission of the pumping wavelength (808 nm). On rider for optical bench KL.

U14025



U14085

Laser Safety Goggles for Nd:YAG Laser

Nylon goggles for average protection levels, integral construction for reduced weight with enlarged visual field due to large filter lenses. Supplied in a storage pouch.

Filter colour:	light blue
Degree of light transmission:	$T_{D65} = 62\%$
Specification according to DIN EN 207/208:	750 – 1100 D L5 + IR L7 > 1100 – 1200 DIR L5

U14085

Infra-Red Detector Card (not shown)

Converter card for converting infra-red light into visible light. Held directly in a laser to act as a sensor.

Dimensions:	90x60 mm ²
-------------	-----------------------

U10530

Safety instructions:

The system described here is a class four laser. The laser light emitted is not visible to the naked eye but is nevertheless highly hazardous for eyes and also dangerous for skin. It can also cause fires or explosions.

- Observe safety regulations for class 4 lasers
- Always wear goggles which can protect you from laser beams
- Even with protective goggles, do not look straight into the laser beam.

Diode Laser 1000 mW

1000 mW diode laser for optical pumping of Nd:YAG laser. With built-in Peltier cooler and thermistor plus collimating and focussing lens. On rider for optical bench KL.
Emission wavelength: 808 nm

U14022

Alignment Laser Diode

Tunable laser diode, on rider for optical bench KL.
Wavelength: 633 nm
Power: 1 mW

U14024

Frequency Doubling Module

Module with KTP crystal (potassium titanyl phosphate) for use as a non-linear optical element for frequency doubling, featuring built-in Peltier cooler and thermistor. In rotating holder on rider for optical bench KL.

U14026

Cr:YAG-Module

Module with Cr:YAG crystal for passive Q-switch circuit. On rider for optical bench KL.

U14027

Laser Mirror

Mirror for laser light of wavelength 1064 nm with spherical curvature. Includes adjustment mounting, on rider for optical bench KL.
Radius of curvature: -200 mm
Reflection coefficient: 97%

U14028

Laser Mirror HAT, 532 nm (not shown)

Mirror for laser light with spherical curvature for decoupling frequency-doubled laser beams of wavelength 532 nm. Includes adjustment mounting, on rider for optical bench KL.
Radius of curvature: -200 mm

U14029

PIN Photodiode DET 36 A/M

PIN photodiode in casing with thread for accommodating filters. On rider for optical bench KL.
Rise time/fall time: <14 ns
Wavelength range: 350 – 1100 nm
Detector surface: 13 mm²
Battery: E23, 12 V

U14038

PIN Photodiode DET 10 A/M (not shown)

PIN photodiode in casing with thread for accommodating filters. On rider for optical bench KL.
Rise time/fall time: <1 ns
Wavelength range: 200 – 1100 nm
Detector surface: 0.8 mm²
Battery: E23, 12 V

U14039

Collimator Lens, f = +75 mm

Collimator lens, f = +75 mm, with anti-reflective coating on both sides. On rider for optical bench KL.

U14044

Filter RG850 (not shown)

RG850 filter for suppressing pumping radiation. In holder with screw thread.

U14046

Filter BG40 (not shown)

BG40 filter for suppressing fundamental wavelength. In holder with screw thread.

U140471

Transport Case KL (not shown)

Padded transport case for all solid body laser components.

U14049



U14022



U14026



U14028



U14027



U14044



U14024



U14038

Experiment: “Tuning of Diode Laser for Stable Optical Pumping”

- Measurement of output power of diode laser as a function of applied current.
- Determination of how wavelength depends on temperature.
- Determination of how wavelength depends on injection current.
- Determination of injection current-temperature curve at constant wavelength (maximum absorption).

Number / Description	Art. No.
1 Laser Diode Driver and Temperature Controller	U14021
1 Diode Laser 1000 mW	U14022
1 Nd:YAG Module	U14025
1 Alignment Laser Diode	U14024
1 PIN Photodiode DET 36 A/M	U14038
2 Collimator Lens, f = +75 mm	U14044
1 Filter RG850	U14046
1 Optical Bench KL	U14040
1 Transport Case KL	U14049
1 Laser Safety Goggles for Nd:YAG Laser	U14085
1 Infra-Red Detector Card	U10530

Experiment: “Set-Up and Optimisation of Nd:YAG Laser”

- Tuning of diode laser for stable optical pumping of Nd:YAG laser.
- Determination of lifetime of the upper laser level ${}^4F_{3/2}$ in an Nd:YAG crystal.
- Adjustment of resonator and observation of resonator modes.
- Measurement of output power of Nd:YAG laser as a function of pumping power and determination of laser threshold.
- Observation of spiking in pulsed operation of laser diode.

Number / Description	Art. No.
1 Laser Diode Driver and Temperature Controller	U14021
1 Diode Laser 1000 mW	U14022
1 Nd:YAG Module	U14025
1 Alignment Laser Diode	U14024
1 Laser Mirror	U14028
1 PIN Photodiode DET 36 A/M	U14038
1 Filter RG850	U14046
1 Optical Bench KL	U14040
1 Transport Case KL	U14049
1 Laser Safety Goggles for Nd:YAG Laser	U14085
1 Infra-Red Detector Card	U10530
1 Digital Multimeter P3340	U118091
1 Digital Oscilloscope 4x60 MHz	U22060
1 HF Patch Cord, BNC/4 mm Plug	U11257
1 HF Patch Cord	U11255

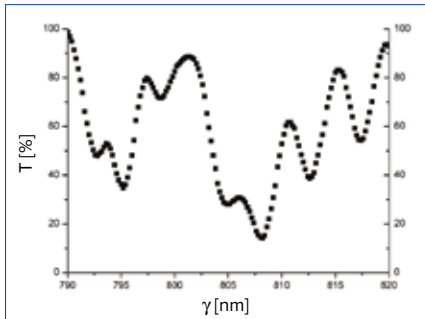

Transmission spectrum of an Nd:YAG crystal as a function of wavelength, recorded using a spectrometer

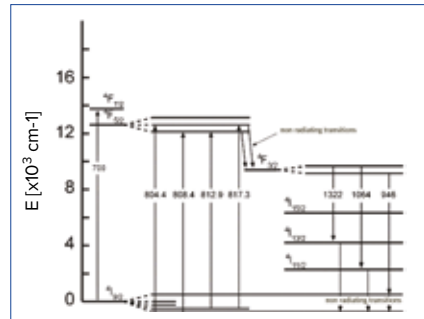

Energy level diagram for an Nd:YAG crystal with the most important transitions for optical pumping and laser operation

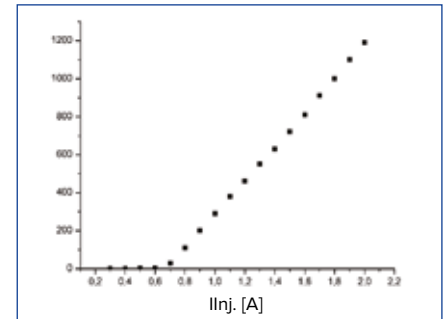

Output power of diode laser at 20°C as a function of the injection current

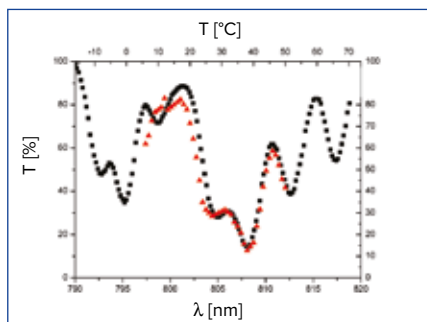

Comparison of transmission functions:
Square – $T(\lambda)$ recorded using a spectrometer
Triangular – Transmission as a function of temperature

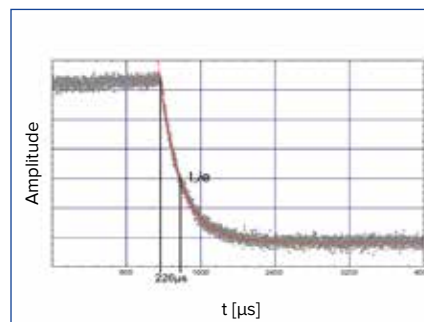

Measurement of half-life for the ${}^4F_{3/2}$ level in an Nd:YAG crystal.
An exponential function has been fitted to the measurements

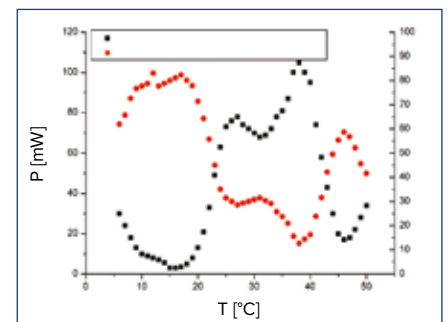

Transmission of light from a diode through an Nd:YAG crystal as a function of temperature for various injection currents

Experiment: “Q-Switch Circuit for Nd:YAG Laser with Cr:YAG Module”

- Set-up and optimisation of Q-switch circuit
- Recording of pulses and determination of pulse duration.



UE4070320
PDF online

Experiment: “Frequency Doubling with an Nd:YAG Laser”

- Frequency doubling within the resonator using a KTP crystal
- Measurement of output power of frequency-doubled beam as a function of power of fundamental wave.
- Investigation of dependency on crystal orientation and temperature.



UE4070330
PDF online

Number / Description	Art. No.
1 Laser Diode Driver and Temperature Controller	U14021
1 Diode Laser 1000 mW	U14022
1 Nd:YAG Module	U14025
1 Alignment Laser Diode	U14024
1 Cr:YAG Module	U14027
1 Laser Mirror	U14028
1 PIN-Fotodiode DET 10 A/M	U14039
1 Filter RG850	U14046
1 Optical Bench KL	U14040
1 Transport Case KL	U14049
1 Laser Safety Goggles for Nd:YAG Laser	U14085
1 Infra-Red Detector Card	U10530
1 Digital Multimeter P3340	U118091
1 Digital Oscilloscope 4x60 MHz	U22060
1 HF Patch Cord, BNC/4 mm Plug	U11257
1 HF Patch Cord	U11255

Number / Description	Art. No.
1 Laser Diode Driver and Temperature Controller	U14021
1 Diode Laser 1000 mW	U14022
1 Nd:YAG Module	U14025
1 Alignment Laser Diode	U14024
1 Frequency Doubling Module	U14026
1 Laser Mirror HAT, 532 nm	U14029
1 PIN Photodiode DET 36 A/M	U14038
1 Filter BG40	U140471
1 Filter RG850	U14046
1 Optical Bench KL	U14040
1 Transport Case KL	U14049
1 Laser Safety Goggles for Nd:YAG Laser	U14085
1 Infra-Red Detector Card	U10530
1 Digital Multimeter P3340	U118091
1 HF Patch Cord, BNC/4 mm Plug	U11257

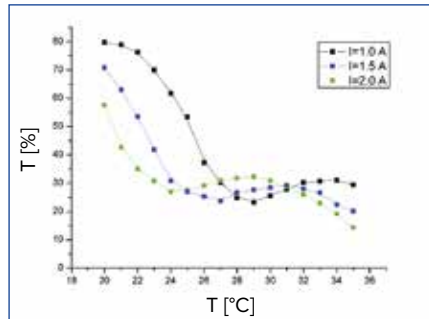

Comparison of curve characteristics for transmission of light through an Nd:YAG crystal and output power of the Nd:YAG laser as a function of the diode temperature

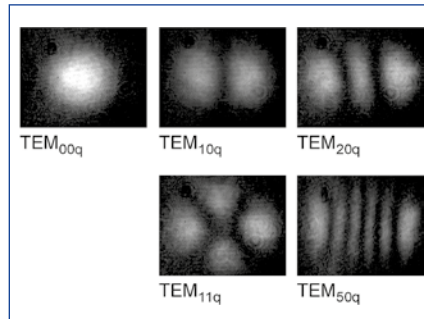

Transverse modes

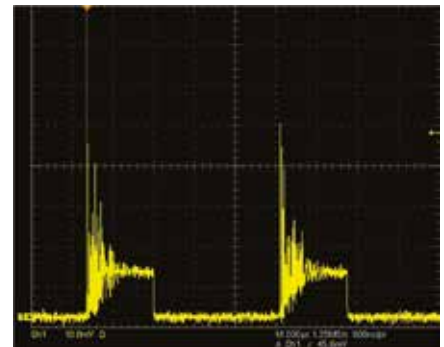

Oscilloscope trace: spiking in a Nd:YAG laser

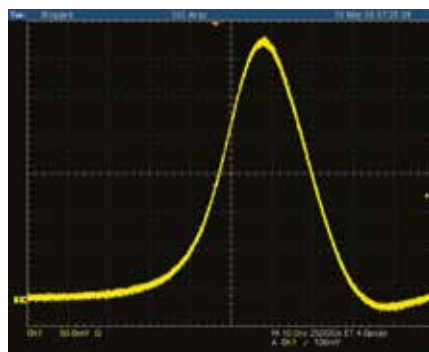

Oscilloscope trace: trace of pulses from a passive Q-switched Nd:YAG laser. Pulse duration 25 ns

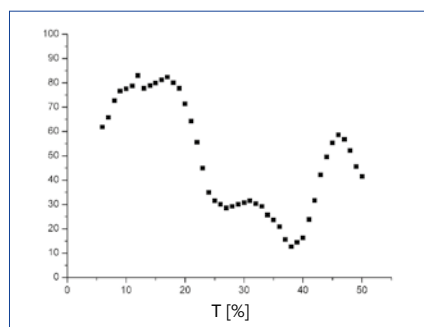

Transmission of light from a diode through an Nd:YAG crystal as a function of temperature at an injection current of 1.5 A

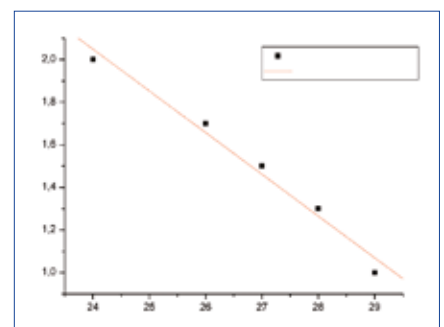

Current-temperature graph at constant wavelength

Experiment topics:

- Glass fibres and optical telecommunications
- Acceptance cone and optimisation of coupling to a fibre optic cable
- Absorption, effect of the length of the transmission line
- Coupling losses
- Diffraction by an optical grating and optical multiplexing.
- Dichroitic filters and optical demultiplexing
- Spectral composition of light sources
- Spectral dispersion and recombination
- Colour and interference filters
- Signal shaping and matching
- Band width and limiting frequency
- Calculation of theoretical band width
- Optical diaphony

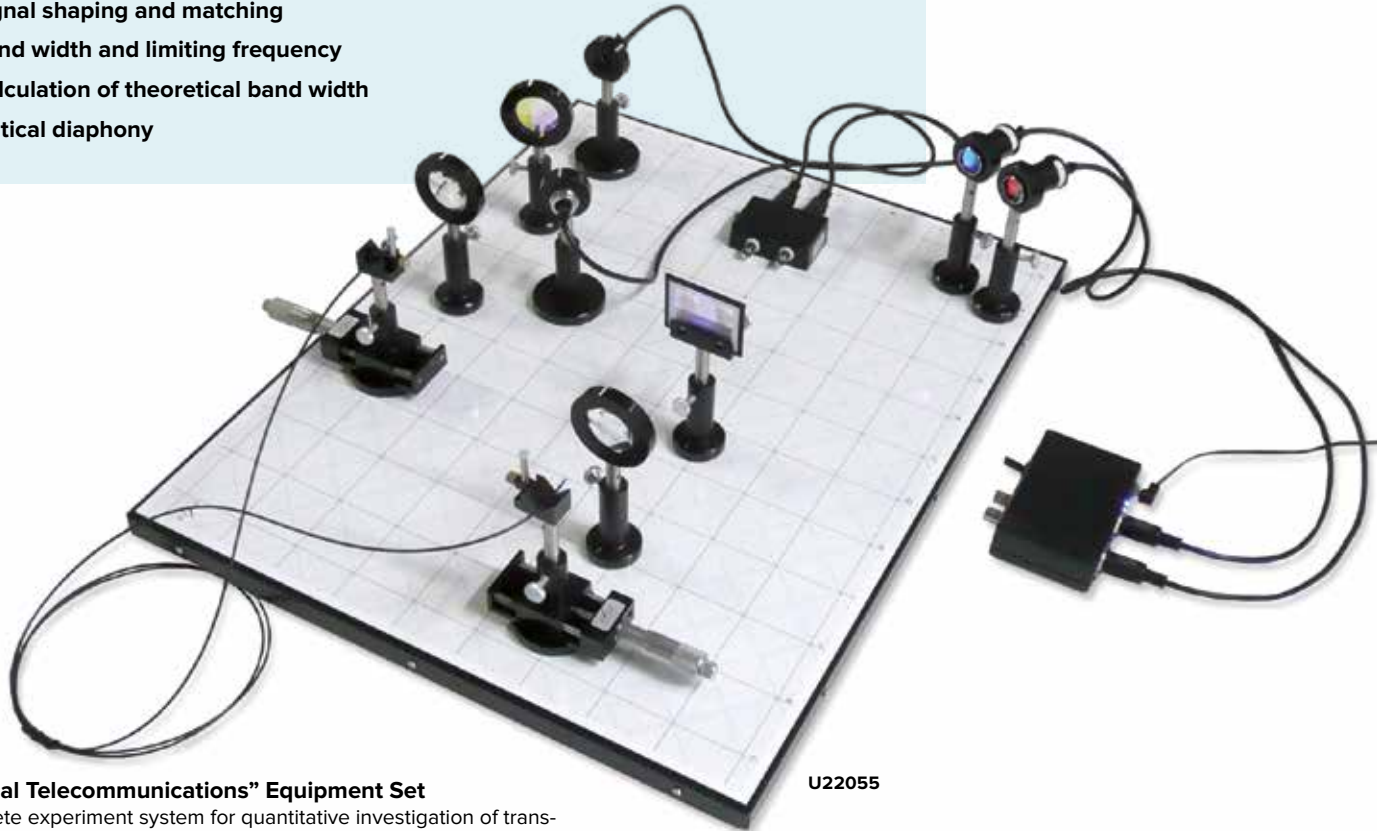

U22055

“Optical Telecommunications” Equipment Set

Complete experiment system for quantitative investigation of transmission of signals via optical media, plus the processes of optical multiplexing and demultiplexing. To build a two-dimensional optical system of high precision, a magnetic bench with a printed grid is provided, upon which it is possible to write.

Optical bench:

Available surface: 600x480 mm²
 Grid radials: 0°, 45°, 90°, 135°
 Grid subdivisions: 5 cm, 1 cm
 Weight: 12 kg approx.

Contents:

- 1 Optical bench, 600x480 mm, for attachment of magnetic components
- 8 Optical riders with magnetic base
- 2 Movable riders, l = 25 mm, with magnetic base
- 1 LED with collimating lens, in frame on stem, red
- 1 LED with collimating lens, in frame on stem, blue
- 1 Electronic signal transmitter, including power supply
- 1 Electronic signal receiver, including power supply
- 2 Phototransistors in housing on stem
- 1 Fibre-optic cable with SMA plugs, 1 m
- 1 Diffraction grating, 600 lines/mm
- 1 Dichroitic filter in housing on stem, blue
- 1 Dichroitic filter in housing on stem, yellow
- 2 Converging lenses in housing on stem, f = 50 mm, 40 mm diam.
- 1 Slide holder for gratings, on stem
- Component holders and spring clips

U22055

Additionally recommended:

- U22056 “Spectrometry” Supplementary Set**
- U22065 Two-Channel Function Generator, 20 MHz**
- U22060 Digital Oscilloscope 4x60 MHz**
- U11255 HF Patch Cord (6x)**
- U11261 T-Piece, BNC (2x)**

“Spectrometry” Supplementary Set (not shown)

Supplement to the “Optical telecommunications” equipment set for investigating spectrometry of transmitted signals and measurement of absorption losses.

Contents:

- 1 Spectrometer with SMA connectors
- 1 Reference light source with SMA connectors
- 5 Fibre optic cables with SMA plugs, 2 m
- 1 Fibre optic cable with SMA plugs, 10 m
- 5 SMA/SMA connectors

U22056

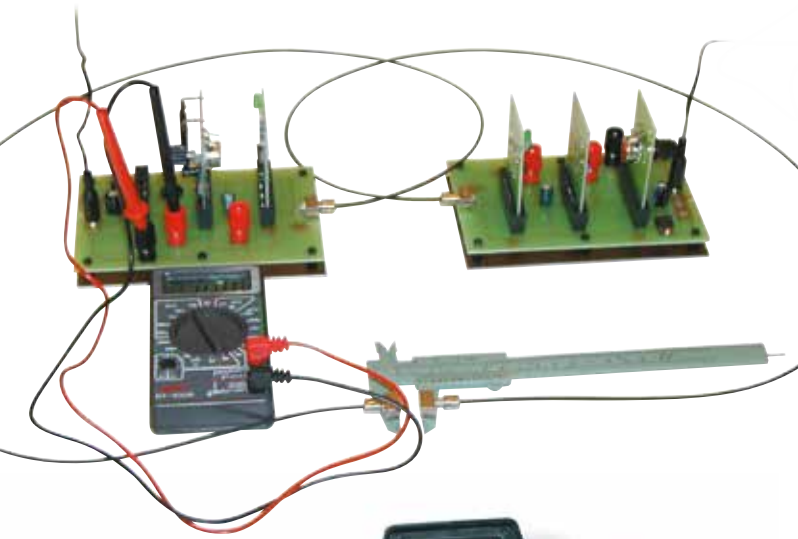

Experiment Topics:

- Tyndall's light guide experiment
- Attenuation in curved optical waveguides
- Attenuation in liquids
- Attenuation at optical transitions
- Setup for force measurement
- Setup of light barrier
- Setup for proximity sensor
- Transmission of audio signals
- Data transmission between two computers



U17304

Equipment Set for Waveguide Optics

Complete modular experiment set for examining optical waveguide phenomena and their applications. Consisting of one base PCB for use as a transmitting and receiving module, one analogue transmitting and receiving unit, one digital transmitting and receiving unit, one microphone amplifier and low-frequency generator, one low-frequency amplifier with integrated loudspeaker, USB interface for transmitter and receiver, one digital multimeter, sheathed and unsheathed optical fibres of different lengths and all connecting cables. Including universal plug-in power supplies and storage case.

Wall power supply units: 100 – 240 V AC (primary)
9 V DC (secondary)

U17304

Additionally recommended:

U11175 Analogue Oscilloscope

U11257 High-Frequency Patch Cord, BNC / 4-mm Plug

Equipment Set for Laser Communication

Experiment system for transmitting audio and video signals with a laser beam. Consisting of power supply for laser diode with variable output power and with audio and video input for modulation of laser beam, receiver unit with integrated amplifier and connectors (CINCH) for loudspeakers and TV set, microphone and loudspeaker. Audio signals are frequency modulated and video signals amplitude modulated. For transmitting video signals, any PAL or NTSC video camera (refer to p. 292) can be connected (not included in scope of delivery). Including universal plug-in power supplies and storage case.

Laser diode: Laser protection class II
Wavelength: 635 nm
Laser power: 0.2 – 1mW continuously variable
Plug-in power supply: 100 – 240 V AC 50/60 Hz (primary),
12 V DC (secondary)

U17305



U17305



Light Speed Meter

Equipment set for determining the speed of light thanks to electronic run-time measurement. Comprises a compact housing containing a transmitter emitting short LED pulses, a photo receiver and a calibrated, oscillating quartz generator producing chronologically precise square-wave pulses. Emitted light pulses are returned by an internal reflector and by a triple-prism reflector placed a long distance from the light source. The returning light signals are then superimposed on the original signal. A dual-channel oscilloscope is used to measure the time difference between the two signals. The speed of light can be calculated from this difference and the distance to the triple-prism reflector. The triple-prism reflector can be installed by eye without the need for complex adjustments

Contents:

- 1 Control unit with a transmitter, receiver and integrated power supply unit
- 1 Fresnel lense on shaft
- 1 Triple-prism reflector on shaft
- 3 HF cables, 1 m

Light Speed Meter (230 V, 50/60 Hz)

U8476460-230

Light Speed Meter (115 V, 50/60 Hz)

U8476460-115

Additionally required:

- U11167 Digital Oscilloscope, 2 x100 MHz**
- Optical Bench**
- Optical Rider (2x)**
- Stand Equipment**



U8476460-230
U8476460-115

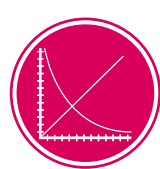
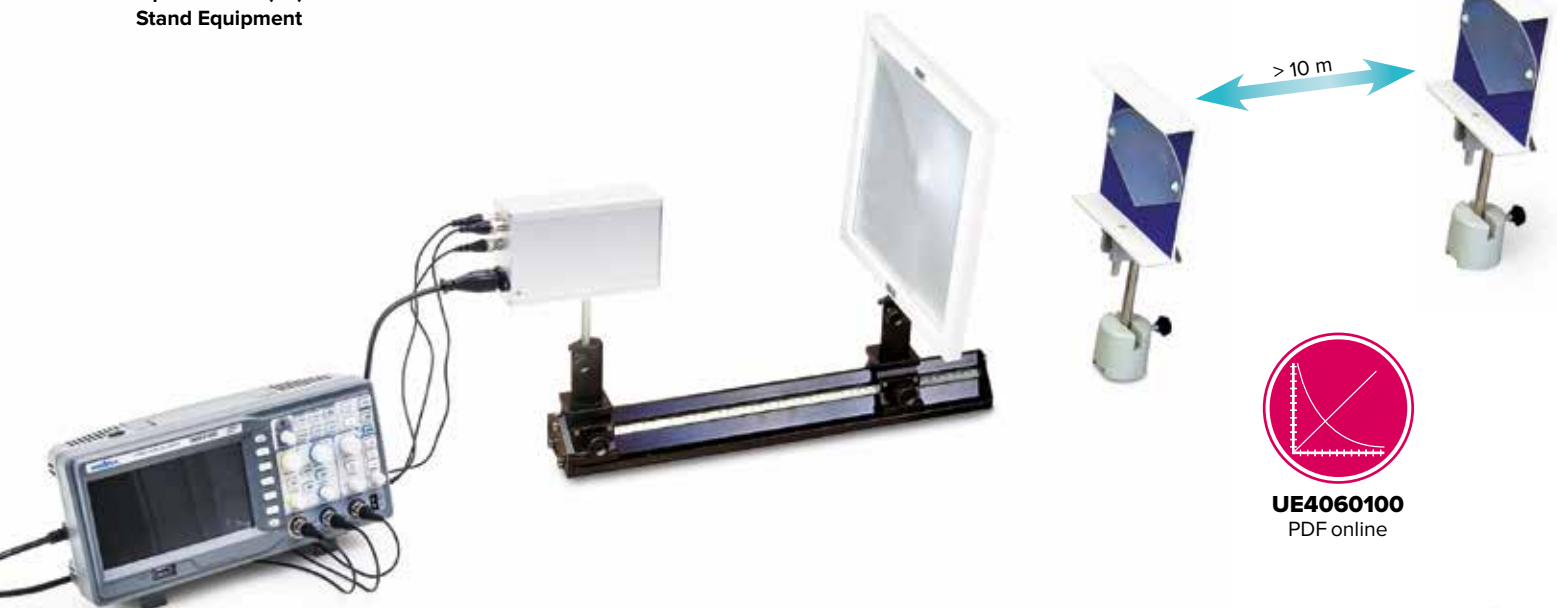

UE4060100
PDF online

Funhouse Mirror

The Funhouse Mirror is a high grade polyester sheet with vacuum deposited silver metal surface. The mirror is 0.8 mm thick; it will not tear but can be cut with normal scissors. Keep out of sunlight as it can focus light and heat to start fires. Comes rolled into 4 cm tube, will unroll flat. This is a great way to teach concave and convex mirrors and real and virtual images. Many applications, use your imagination! For attachment to wall with double-sided adhesive tape.

Funhouse Mirror 135x210 cm²

U40275

Funhouse Mirror 60x130 cm²

U40276



U40275/U40276

Experiment Topics:

- Adaptation (accommodation) of the eye's lens
- Short-sightedness
- Long-sightedness
- Presbyopia
- Correction by means of spectacles

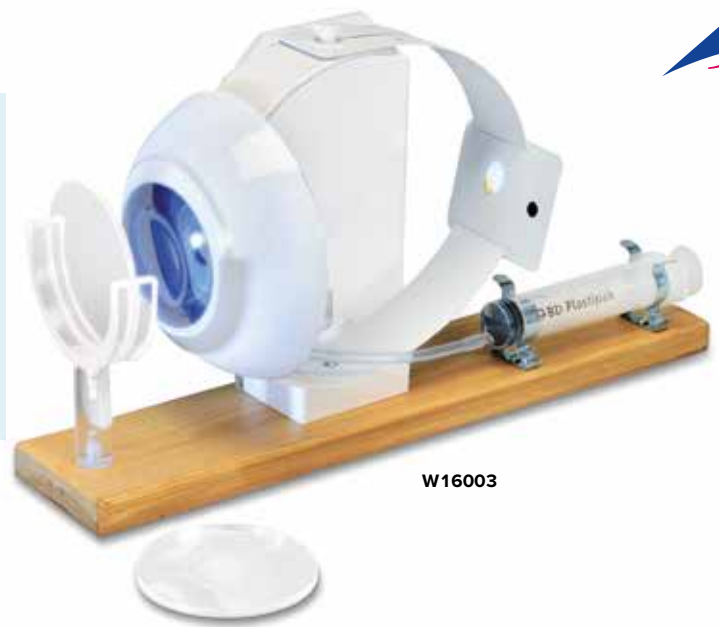

W16003

Functional Model of the Eye

Model for demonstrating the functions of the human eye, including inverted display of images on the retina. The curvature of the silicone lens can be changed by means of water pressure in order to demonstrate the process of accommodation. A holder serves to position corrective glass lenses in front of the eye's lens. The set is mounted on a wooden base and includes an optical object, glass lenses (-0.5 D, +1.0 D) and English operating instructions.

Dimensions: approx. 320x180 mm²

Weight: approx. 1.5 kg

W16003

6-Piece Model of a Human Eye

Model of a human eye enlarged to 3 to 1 scale. Features sclera (white of the eye) and cornea plus muscle attachments, which can be separated into two halves, plus choroid with retina and iris, which is also separable into two, as well as a lens and a glass body. Mounted on base.

Dimensions: 90x90x150 mm³ approx.

Weight: 100 g approx.

F15



F15

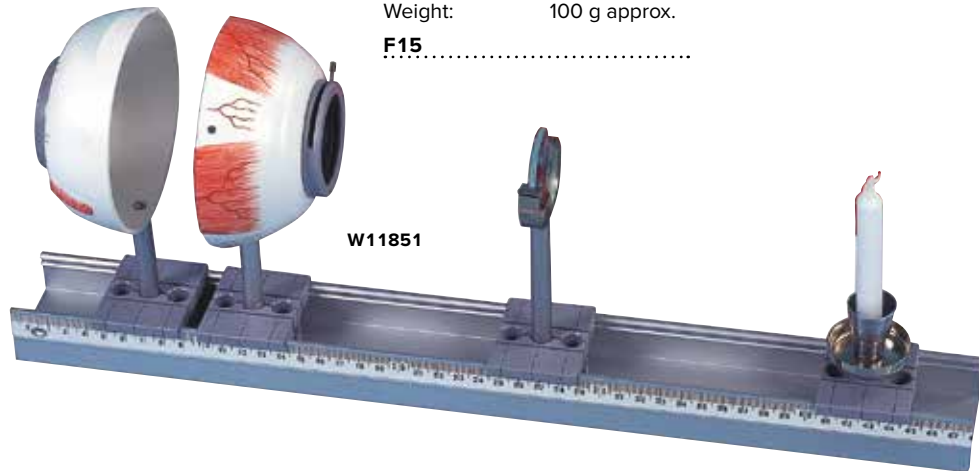

W11851

Physical Eye Model

This model can be used to demonstrate the optical functions of the eye, e.g. representation of an object on the retina, accommodation (change in the lens curvature), short sightedness and far sightedness. The model comprises:

- Half eyeball with adjustable iris diaphragm, lens holder and 2 convex lenses ($f = 65$ mm and 80 mm), on a rod
- Half eyeball with retina (transparent screen), on a rod
- Lens holder with one concave and one convex corrective lens, on a rod
- Candle holder with 2 candles, on a rod
- Aluminium rail, 50 cm long, with 4 clamp slides
- Storage case

49x5.5x18 cm; 2.0 kg

W11851





U15300-230
U15300-115

Van de Graaff Generator

Generator for the generation of DC potentials with low current for multiple experiments in electrostatics. Detachable conductor sphere, drive motor with controllable speed, including small discharge sphere on rod.

- Voltage: up to approx. 100 kV
- Length of sparks: up to 5 cm
- Conductor sphere: 190 mm diam.
- Sphere on rod: 460 mm, diam. 90 mm
- Dimensions: approx. 240x190x620 mm³

Van de Graaff Generator (230 V, 50/60 Hz)

U15300-230

Van de Graaff Generator (115 V, 50/60 Hz)

U15300-115

Electrostatic Equipment Set

Using this equipment many historical experiments can be performed to investigate electrostatic phenomena. The components are equipped with 4 mm connector pins thus providing for rapid and easy interchangeability of assembly on an insulated stand. Connection chains are included for connection to the charge source, but experiment cables with 4 mm plugs can also be used. We recommend that the Wimshurst machine (U15310) be used as a charge source in these experiments.

Contents:

- 1 Standbase
- 1 Stand rod, insulated, with retaining and connection socket
- 1 Conductor sphere 30 mm diam., with pin
- 1 Rolling sphere race
- 1 Elder-pith double pendulum with hook stand
- 10 Pieces of elder-pith (in box)
- 1 Box with spherical electrode
- 1 Box with pointed electrode
- 1 Triskelion wheel on needle bearing
- 1 Bundle of tissue paper strips on rod
- 1 Luminous pane
- 1 Chimes with bells
- 1 Friction rod, plastic, with 4 mm socket
- 2 Connection chains
- 1 Experiment instructions

U8491500

Additionally required:

U15310 Wimshurst Machine



U15310

Wimshurst Machine

Historical experiment set-up for the generation of safe, high DC potentials for numerous experiments in the area of electrostatics. Hand crank operation and belt drive, adjustable spark gap, two high-voltage capacitors (Leyden jars).

- Diameter: 310 mm
- Spark gap: max. 120 mm
- Dimensions: approx. 360x250x400 mm³
- Weight: approx. 3.4 kg

U15310

Rubber Belt for Van de Graaff Generator (not shown)

Spare rubber belt for Van de Graaff generator (U15300-230 or U15300-115).

- Length: 930 mm
- Width: 50 mm

U15301



U8491500



U17250

Electroscope

Pointer instrument for the detection of electrical charges and voltages. Shielding ring with 4 mm earthing sleeve. Suitable for shadow projection. Includes sphere, capacitor plate on 4 mm plug and capacitor plate on insulating rod.
Diameter: approx. 130 mm

U17250



U8532131

Kolbe's Electroscop

Pointer instrument for the detection of electrical charges and voltages with high sensitivity. Metal housing with 4 mm earthing sleeve, glass front and rear, needle with pivot bearing, scale, suitable for shadow projection. Includes capacitor plate on 4 mm plug.
Measuring range: 0 – 6 kV
Dimensions: approx. 170x110x190 mm³

U8532131



U8490210

Piezoelectric Charge Source

Hand-held unit used for the simple generation of safe voltages needed in electrostatic experiments. Featuring the functional principle of a piezoelectric gas lighter. With shortened earthing sleeve and 4 mm cable plug. The colour may deviate from the colour in the image.
Voltage: ±4.5 kV
Dimensions: approx. 250x25x33 mm³
Weight: approx. 130 g

U8490210



U8557120

Electroscop S

Inexpensive instrument with dial for demonstrating electrical charge and voltage potential. Designed in the form of a stand base, frame, aluminium rod with magnet holder and electroscop unit.
Dimensions: 280x80x280 mm³ approx.
Weight: 500 g approx.

U8557120



U8557100

Charge Indicator

Display instrument for showing electric charge and its sign, whereby either a blue or a red LED lights up in the presence of charge. Includes two 1.5-V batteries (AA).
Dimensions: 62x67x20 mm³ approx.
Weight: 85 g approx.

U8557100



U8557110

Charge Storage Device with Piezo Charger

Storage device for electric charge generated by a piezo charger. The stored charge can be transferred from place to place using a so-called "charge-spoon", for example.
Capacitance: 2x 1 nF
Dimensions of storage device: 62x67x50 mm³ approx.
Dimensions of charger: 230x35x40 mm³ approx.
Total weight: 85 g approx.

U8557110

Additionally recommended:
U11051 Charge Spoon, Small



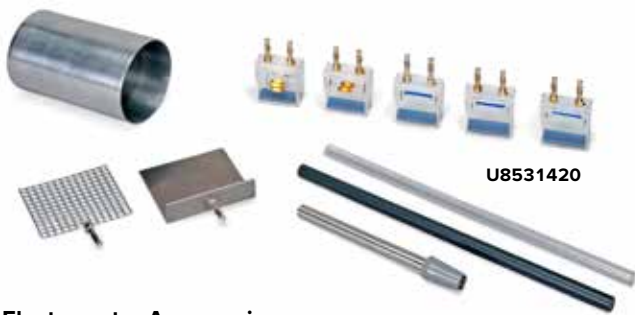

U8531420

Electrometer Accessories

Set of accessories for carrying out basic experiments on electrostatics, electricity and the photoelectric effect in combination with an electrometer (U8531408-230 or U8531408-115) and 450 V DC power supply (U8521400-230 or U8521400-115).

Contents:

- 1 Faraday cup
- 1 Pair of friction rods
- 1 Metal rod with 4 mm drilled hole
- 1 Safety adaptor socket
- 1 plug-in capacitor 1 nF
- 1 plug-in capacitor 10 nF
- 1 plug-in resistor 100 MΩ
- 1 plug-in resistor 1 GΩ
- 1 plug-in resistor 10 GΩ
- 1 Zinc electrode
- 1 Grid electrode

U8531420

Conducting Spheres with 4 mm Plugs

Conducting spheres for electrostatics experiments, e.g. for determining the capacity of a sphere or for experiments on the influence of nearby objects.

Conducting Sphere, diam. = 85 mm, with 4 mm Plug

U8492350

Conducting Sphere, diam. = 30 mm, with 4 mm Plug

U8532126

Additionally recommended:

U11055 Drilled Rod



U8492350

U8532126



U8496460

Faraday Cup

Faraday pail with 4 mm plug, e.g. for mounting on an electrostatic voltmeter (U17250 or U8532131) or electrometer amplifier (U8531408-230 or U8531408-115).

Dimensions: 115 mm x 70 mm diam. approx.

U8496460

Friction Rods

Two rods for experiments on frictional electricity, made of PVC and acrylic.

Length: approx. 250 mm

Diameter: approx. 10 mm

U11053

Charge Spoon

Metal plate on insulating rod for charge transport and for experiments on electrostatic induction.

Art. No.	Designation	Length	Plate	Rod
U11051	Charge Spoon, small	205 mm	40x35 mm ²	10 mm diam.
U11052	Charge Spoon, large	265 mm	40x70 mm ²	10 mm diam.

Experiment Topics:

- Measurement of charge and voltage in electrostatics
- Measurement of charge and voltage for a plate capacitor
- Ionisation of air by burning gases or α radiation
- Hallwachs effect (external photoelectric effect)



U8531408-230
U8531408-115

Electrometer

Impedance converter with high-resistance input for measuring extremely small charges and currents. The input signal is converted into a proportional voltage, which can then be measured with an external voltmeter. During the measurement the potentials of the electrometer and the experimenter must be matched by using a metal rod connected to earth. Includes a 12 V AC plug-in power supply.

Electrometer gain factor: 1.00

Input resistance: $>10^{12} \Omega$

Output resistance: $<1 \text{ k}\Omega$

Input current: $<10 \text{ pA}$

Input capacitance: $<50 \text{ pF}$

Max. output voltage: $\pm 10 \text{ V}$

Resistance to excess

voltage: 1 kV (from low-resistance sources)

10 kV (from high-resistance sources)

Supply voltage: 12 V AC

Dimensions: 110x170x30 mm³ approx.

Weight: 1 kg approx.

Electrometer (230 V, 50/60 Hz)

U8531408-230

Electrometer (115 V, 50/60 Hz)

U8531408-115

Additionally recommended:

U8531420 Electrometer Accessories

U17450 Analogue Multimeter AM50

U8521400-230 DC Power Supply 450 V (230 V, 50/60 Hz)

or

U8521400-115 DC Power Supply 450 V (115 V, 50/60 Hz)



U11052

U11051

U11053

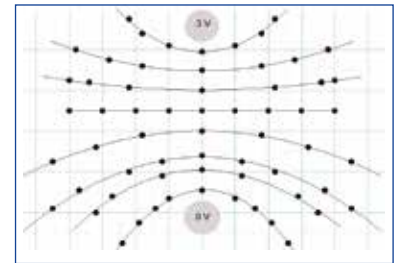
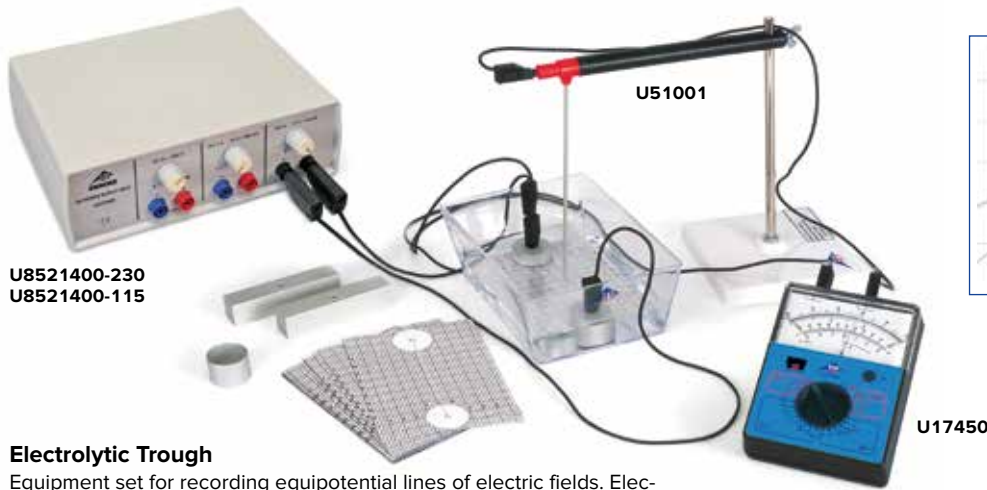

Equipotential lines of point charges

Electrolytic Trough

Equipment set for recording equipotential lines of electric fields. Electrodes of different shapes can be used to measure equipotential lines for a plate capacitor, dipole, induced surface charge and a Faraday beaker.

Trough dimensions: 160x105x65 mm³ approx.

Contents:

- 1 Plastic trough
- 1 Stand with measurement electrode
- 2 Bar electrodes
- 2 Round disc electrodes
- 1 Ring electrode
- 20 Sheets of millimetre-grid paper

U51001

Required Apparatus for Experiment UE3020100:

Number / Description	Art. No.
1 Electrometer (230 V, 50/60 Hz) or Electrometer (115 V, 50/60 Hz)	U8531408-230 U8531408-115
1 Electrometer Accessories	U8531420
1 Analogue Multimeter AM50	U17450
1 Burette, 10 ml	U14224
1 Constantan Wire 0.2 mm / 100 m	U8495527
1 DC Power Supply 450 V (230 V, 50/60 Hz) or DC Power Supply 450 V (115 V, 50/60 Hz)	U8521400-230 U8521400-115
1 Digital Multimeter P3340	U118091
1 Digital Stopwatch	U11902
1 Tripod Stand 150 mm	U13270
1 Stainless Steel Rod 1000 mm	U15004
2 Universal Clamp	U13255
1 Universal Jaw Clamp	U13261
1 Set of 10 Crocodile Clips 4 mm, Not Insulated	U13821
1 Set of 3 Safety Experiment Leads for Free Fall Apparatus	U13811
2 Pair of Safety Experimental Leads, 75 cm, red/blue	U13816
1 Peleus ball, standard	W17100
1 Set of 10 Beakers, Low Form	U14210
Additionally recommended:	
1 3B NETlog™ (230 V, 50/60 Hz) or 3B NETlog™ (115 V, 50/60 Hz)	U11300-230 U11300-115
1 3B NETlab™	U11310

Additionally required:

U17450 Analogue Multimeter AM50

U8521400-230 DC Power Supply, 450 V (230 V, 50/60 Hz)

or

U8521400-115 DC Power Supply, 450 V (115 V, 50/60 Hz)

DIN-B Burette with Schellbach Stripe, 10 ml

Burette tube for measuring small amounts of liquid with Schellbach stripe and tap at the side with standard ground (NS) glass connector and cock plug.

Volume: 10 ml
Scale divisions: 0.02 ml
Error limits: Class B

U14224

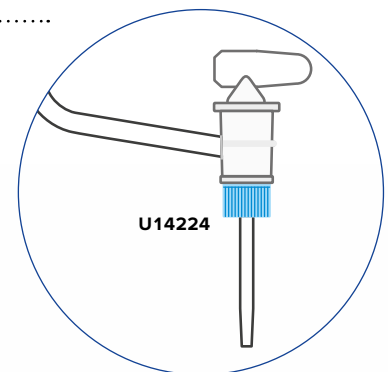

UE3020100
PDF online

Determining the current generated by the movement of the charged water droplets

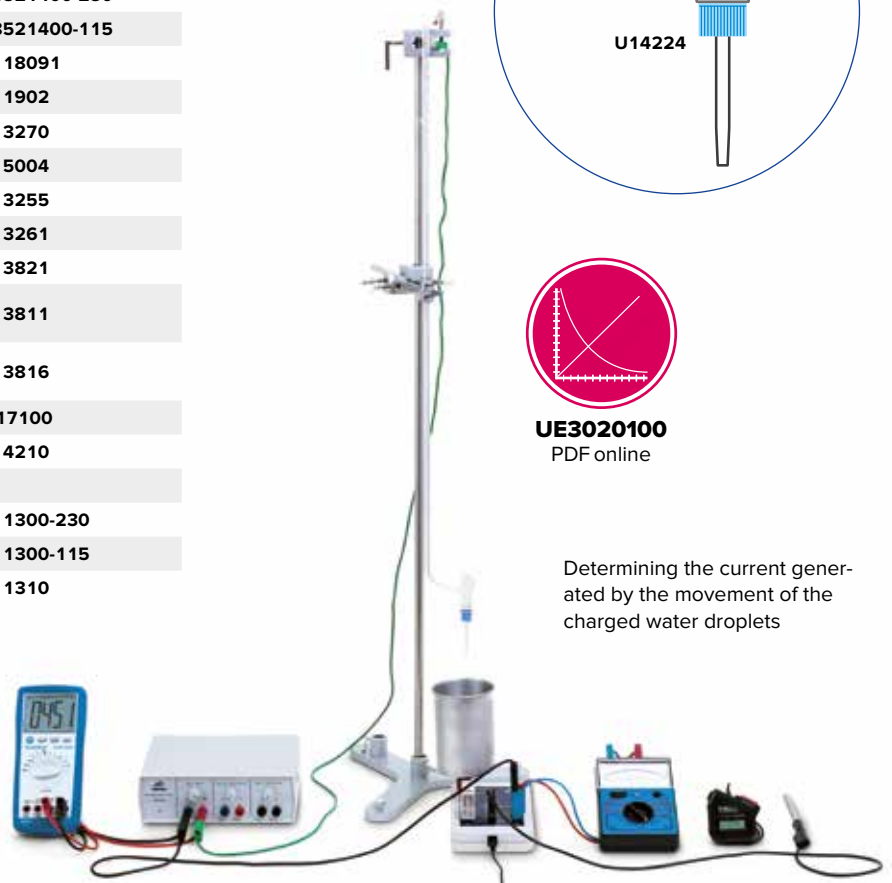



U8533015-230
U8533015-115

- Experiment Topics:**
- Introductory experiments on the functioning of the apparatus
 - Electrostatic tests
 - Measurement of static electric field strength
 - Capacitor tests
 - Measurements of potential with an electrostatic meter



Electric Field Meter

Instrument for static measurements of electric field strength or electrical potential. A star-shaped modulation vane-wheel connected to earth is mounted a short distance in front of a measurement electrode, also star-shaped. Influenced by the electric field, the charges generate an alternating current proportional to the field strength. This alternating current is measured via a selective amplifier without the electric field experiencing any average energy loss over time. When used in conjunction with voltage measurement plates, the instrument can be used as an electrostatic voltmeter. The device is protected against excess voltage. A standard DC voltmeter can be used for display.

Max. output voltage: 10 V
 Measurement ranges: 1 V output can correspond to:
 100 V/cm, 300 V/cm, 1000 V/cm
 10 V, 30V, 100 V
 (with 1x voltage measurement plate)
 100 V, 300 V, 1000 V
 (with 10x voltage measurement plate)

Dimensions: 140x110x70 mm³ approx.
 Weight: 1 kg approx.

Contents:

- 1 Electric field meter
- 1 Voltage measurement plate, measuring range 1x
- 1 Voltage measurement plate, measuring range 10x
- 1 Capacitor measurement plate, 250 cm²
- Set of acrylic spacers

Electric Field Meter (230 V, 50/60 Hz)

U8533015-230

Electric Field Meter (115 V, 50/60 Hz)

U8533015-115

Additionally required:

U17450 Analogue Multimeter AM50

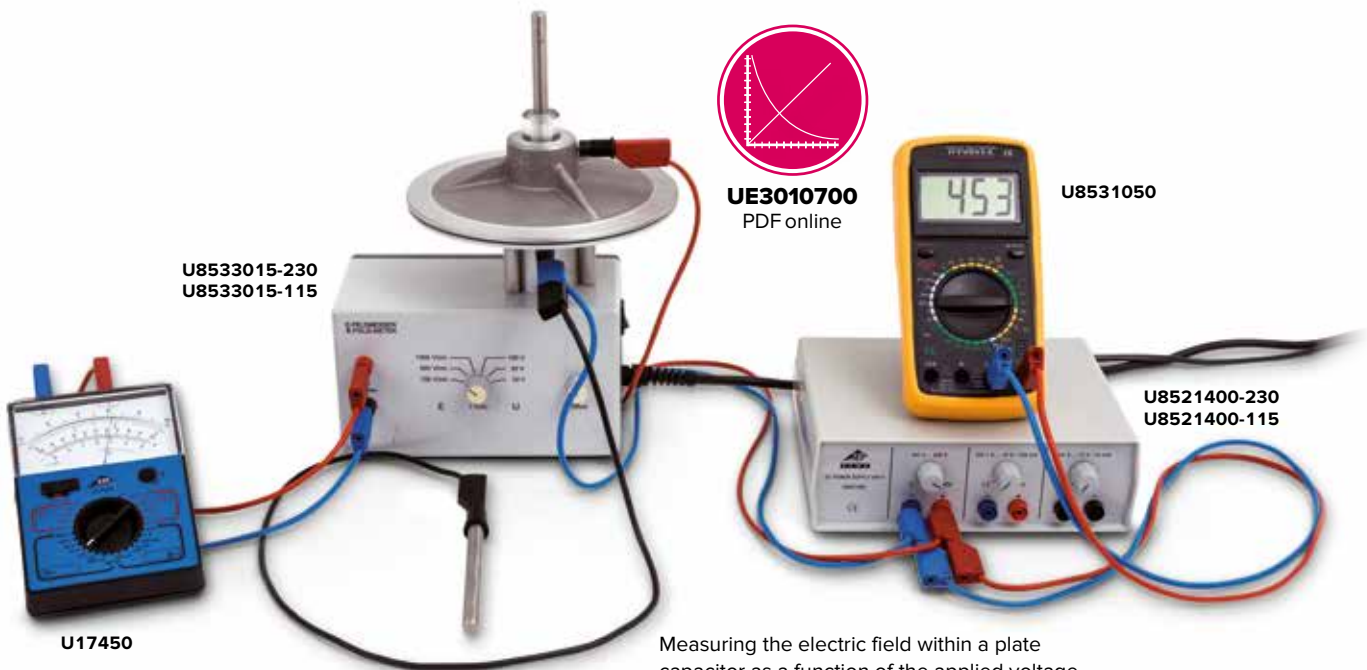

U8533015-230
U8533015-115

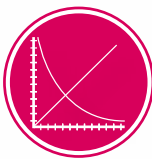

UE3010700
PDF online

U8531050

U17450

U8521400-230
U8521400-115

Measuring the electric field within a plate capacitor as a function of the applied voltage

! Advantage

- Precise determination of plate separation, reading accuracy $\frac{1}{10}$ mm

Plate Capacitor D

Plate capacitor used to investigate the relationship between electric charge and voltage, quantify capacitance as a function of plate spacing, measure the dielectric constant ϵ and precisely determine the electric field constant ϵ_0 . Plate separation can be finely adjusted and read off from a display to an accuracy of $\frac{1}{10}$ mm.

Plate spacing: 0 – 160 mm

Plates can be adjusted between 0 and 20 mm via a spindle

Plates: Solid castings

Plate area: 500 cm²

Weight: 4.2 kg approx.

U8492355

Additionally recommended:

U8492341 Cardboard Plate

U8476371 Transparent Acrylic Plate

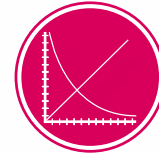

UE3010800
PDF online

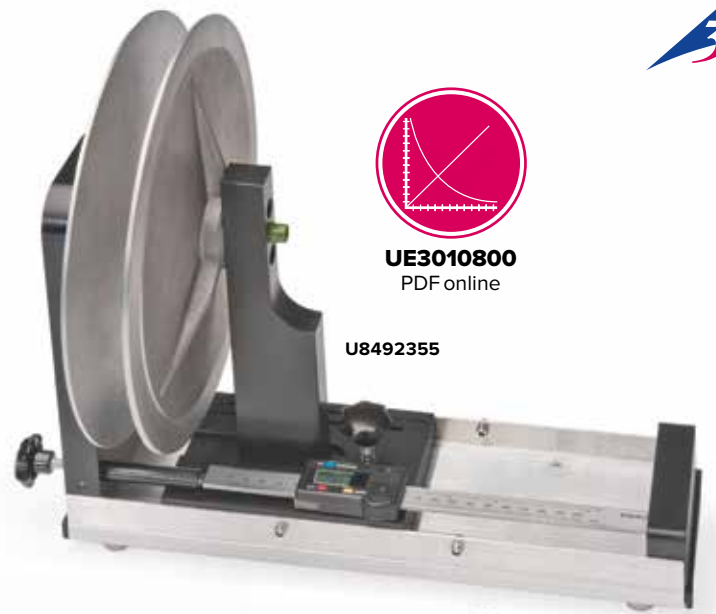

U8492355

Electrostatics



U8492330

U8611200



U8492320

U8611200



U8492310

U8611200

Pair of Capacitor Plates

Pair of capacitor plates consisting of light metal castings with electrically isolated handling rod and 4 mm socket connector for constructing a capacitor. The distance between the plates is determined by the acrylic spacers that are provided.

Pair of Capacitor Plates 500 cm²

U8492310

Pair of Capacitor Plates 250 cm²

U8492320

Pair of Capacitor Plates 125 cm²

U8492330

Additionally required:

U8611200 Barrel Foot, 0.9 kg

Additionally recommended:

U8492341 Cardboard Plate

U8476371 Transparent Acrylic Plate

Dielectric Plates

Dielectric plates for experiments with plate capacitors.

Cardboard Plate

Dimensions: 300x300x2 mm³ approx.

Dielectric constant ϵ : 4.5 F/m approx.

U8492341

Transparent Acrylic Plate

Dimensions: 300x300x2 mm³ approx.

Dielectric constant ϵ : 3.4 F/m approx.

U8476371



U8492341

U8476371

Plate Capacitor S

Plate capacitor used to investigate the relationship between charge, voltage and capacitance, as well as determining the dielectric and electric field constants. It consists of a fixed and a movable plate on a guide rail. A centimeter scale is used to read the plate spacing. The device comes with four dielectric sample plates made of acrylic, bakelite, plywood and cardboard.

Plate spacing: 0 – 150 mm

Plate diameter: approx. 149 mm

Plate area: 175 cm²

Connection: via 4 mm safety jacks

U30040



U30040

Electricity and Magnetism



U8495420 – U8495505



U8495527 – U8495515

Resistance Wires

Metal wires on bobbins, e.g. for experiments to investigate how resistance depends on the material, cross-sectional area and length of the wire.

Art. No.	Material	Length	Diameter
U8495420	Copper	100 m	0.3 mm
U8495460	Iron	100 m	0.3 mm
U8495550	Brass	50 m	0.3 mm
U8495490	Nickel	50 m	0.3 mm
U8495505	Chrome-Nickel	100 m	0.3 mm
U8495515	Chrome-Nickel	50 m	0.5 mm
U8495527	Constantan	100 m	0.2 mm
U8495532	Constantan	100 m	0.3 mm
U8495537	Constantan	50 m	0.4 mm
U8495540	Constantan	50 m	0.5 mm

Holder for Components

Holder on an acrylic base with two crocodile clips for connecting loose resistors and other electronic components or samples from the “Conductors and Insulators” set. Sockets for 4 mm safety plugs.

U8495610



U8495610



U8495310

Lamp Socket E10 on Acrylic Base

Lamp socket on transparent acrylic base with screw connection for ordinary commercial filament bulbs for E10 sockets. Sockets for 4 mm safety plugs.

U8495310



U8495320

Lamp Socket E14 on Acrylic Base

Lamp socket on transparent acrylic base with screw connection for ordinary commercial filament bulbs for E14 sockets. Sockets for 4 mm safety plugs.

U8495320

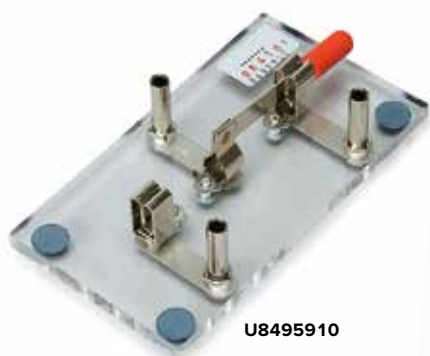

U8495910

Toggle Switch on Acrylic Base

Switch mounted on a transparent acrylic base for the alternate opening and closing of two electric circuits. Sockets for 4 mm safety plugs.

U8495910



U8495930

Momentary Contact Switch on Acrylic Base

Switch mounted on a transparent acrylic base for the momentary closing of circuits. Sockets for 4 mm safety plugs.

U8495930



U8495920

Single-Throw Switch on Acrylic Base

Switch mounted on a transparent acrylic base for the alternate opening and closing of a circuit. Sockets for 4 mm safety plugs.

U8495920



U29509

Set of 10 E10 Lamp Sockets

Set of 10 screw-in sockets for lamps with E10 screw thread. Electrical contact is made via uninsulated wires passing through the connecting eyelets in the base or via crocodile clips.

Base: 28 mm diam.

U29509



U8495350

Set of "Conductors and Non-Conductors"

Samples of eight materials for experiments to investigate the electrical conductivities of different materials. In a storage container.

Materials: Iron, aluminium, copper, steel, wood, glass, plastic, cotton

Sample length: approx. 200 mm

Weight: approx. 200 g

U8495350

Additionally recommended:

U8495610 Holder for Components

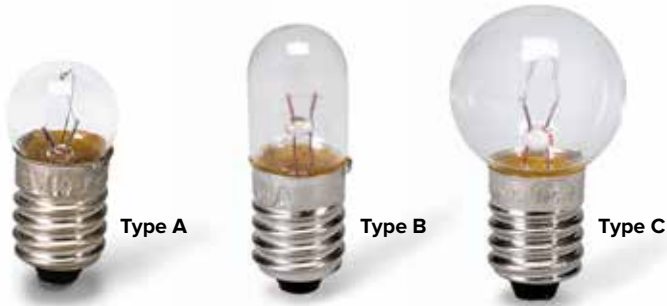

Type A

Type B

Type C

U29512 – U29593

Set of 10 E10 Bulbs

Set of 10 bulbs with E10 screw-in threads. Lamp design A.

Art. No.	Tension	Current
U29514	3.5 V	150 mA
U29515	3.5 V	200 mA
U29589	3.8 V	300 mA
U29590	4 V	40 mA
U29591	6 V	50 mA
U29516	6 V	100 mA
U29517	6 V	350 mA
U29512	12 V	100 mA
U29513	12 V	500 mA

Set of 10 E10 Bulbs, 6 V, 1 A

Set of 10 6 V, 1 A bulbs with E10 screw-in threads. Lamp design C.

U29592

Set of 10 E10 Bulbs, 1.3 V, 60 mA

Set of 10 1.3 V, 60 mA bulbs with E10 screw-in threads. Lamp design B.

U29593

Insulator with Clamp

Metal stem with knurled screw and 4 mm bore hole on acrylic rod, as insulated holder for wires, e.g. when conducting experiments on the optical bench are performed.

Diameter: approx. 10 mm

Length: approx. 100 mm

U15321



U15321

U8713100

U8497740

Rod Clamp with Insulator

Clamp for the insulated securing of electrical components with 4 mm connectors. A PVC isolator is used to isolate sections from each other. Upper section features two 4 mm cross bore holes and one 6 mm hole with clamping screw. Lower section with two 4 mm cross holes.

Total length: approx. 205 mm

Stem diameter: approx. 10 mm

Weight: approx. 135 g

U8713100

Contact Stand with Terminal Sockets

Connection rod on insulated base with three 4mm cross holes and one axial 4 mm bore hole used to secure components with 4 mm connectors or to plug in 4 mm cables. At the top end spring-loaded terminal socket used as a wire clamp.

Height: approx. 130 mm

Shaft: approx. 105x10 mm²

Base: approx. 25x70 mm²

Weight: approx. 210 g

U8497740



U29577



U29579



U29804



U29518



U29530



U29527



U29529



U29510



U29511



U29524

LED on 3B Box

LED in an electrically safe box for assembling simple electric circuits using safety experiment leads. Featuring built-in current limiting resistor and printed circuit symbol.

Maximum voltage: 12 V
 Maximum current: 20 mA
 Dimensions: 135x85x40 mm³

Red LED on 3B Box

U29577

Green LED on 3B Box (not shown)

U29578

Battery Holder in 3B Box

Battery holder in an electrically safe box for assembling simple electric circuits using safety experiment leads. Printed circuit symbol and battery direction. Batteries not included.

Battery: 4.5 V, 3R12, flat battery
 Dimensions: 135x85x40 mm³

U29579

Volta's Pile on 3B Box

Replica of Alessandro Volta's apparatus consisting of series-connected galvanic cells to make up a source of electricity. Zinc and copper plates stacked in alternation on top of each other are separated in each case by a piece of felt soaked in an electrolyte (salt water or acid). The electrolyte makes it possible for electricity to pass between the layers, allowing a voltage to be measured between the plates at the ends.

Connectors: two 4-mm safety sockets
 Electrode diameter: 40 mm
 Case dimensions: 135x85x40 mm³

U29504

Button on 3B Box

Normally open push-button switch attached to a safe box for building simple electric circuits using safety experiment leads. Printed with a circuit symbol.

Maximum voltage: 12 V
 Maximum current: 5 A
 Dimensions: 135x85x40 mm³

U29518

Knife-Edge Switch on 3B Box

Knife-edge switch attached to a safe box for building simple electric circuits using safety experiment leads. Printed with a circuit symbol.

Maximum voltage: 12 V
 Maximum current: 5 A
 Dimensions: 135x85x40 mm³

U29524

Crocodile Clips on 3B Box

Pair of crocodile clips for connecting loose resistors and other electronic components or samples from the "Conductors and Non-Conductors" set. Attached to a safe box for building simple electric circuits using safety experiment leads. Printed with a circuit symbol.

Maximum voltage: 12 V
 Maximum current: 2 A
 Dimensions: 135x85x40 mm³

U29527

Additionally recommended:

- Steel wool
- U8495350 "Conductors and Non-Conductors" Set

Diode in 3B Box

1N4002 semiconductor in an electrically safe box for assembling simple electric circuits using safety experiment leads. Featuring printed circuit symbol.

Maximum voltage: 12 V
 Maximum current: 1 mA
 Dimensions: 135x85x40 mm³

U29529

ELV Motor on 3B Box

Low-voltage motor with pulley for simple experiments on mechanical and electrical energy. The relationship between current direction and direction of rotation is immediately obvious. Built onto an electrically safe box for assembling simple electric circuits using safety experiment leads. Printed circuit symbol.

Voltage: 4 – 6 V DC
 Box dimensions: 135x85x40 mm³

U29530

E10 Lamp Socket on 3B Box

E10 lamp socket attached to a safe box for building simple electric circuits using safety experiment leads. Printed with a circuit symbol.

Maximum voltage: 12 V
 Maximum current: 2 A
 Dimensions: 135x85x40 mm³

U29510

Switch on 3B-Box

Switch attached to a safe box for building simple electric circuits using safety experiment leads. Printed with a circuit symbol.

Maximum voltage: 12 V
 Maximum current: 5 A
 Dimensions: 135x85x40 mm³

U29511



Coil with 600 Windings on 3B-Box

600-winding coil without core attached to a safe box and featuring safety sockets. For experiments on induction, a bar magnet can be passed through the coil.

Dimensions: 135x85x40 mm³

U29595

Additionally recommended:

U11170 Zero-Point Galvanometer, CA 403

U20550 Bar Magnet

Graetz Bridge in 3B Box

Bridge rectifier circuit consisting of four semiconductor diodes connected in Graetz configuration. Inside a safe box for building simple electric circuits using safety experiment leads. Printed with circuit symbols.

Maximum voltage: 12 V

Maximum current: 20 mA

Dimensions: 135x85x40 mm³

U29803

Fuse Holder on 3B Box

Fuse holder attached to a safe box for building simple electric circuits using safety experiment leads. Printed with a circuit symbol.

Fuses (not included): 20 mm x 5 mm diam.

Maximum voltage: 12 V

Maximum current: 5 A

Dimensions: 135x85x40 mm³

U29526

Current Direction Indicator in 3B Box

Circuit comprised of two LEDs for indicating the direction of current. Inside a safe box with sockets for safety experiment leads. Printed with circuit symbols.

Maximum voltage: 12 V

Maximum current: 20 mA

Dimensions: 135x85x40 mm³

U29805

Change-Over Switch (SPDT) on 3B Box

Single-pole double-throw change-over switch attached to a safe box for building simple electric circuits using safety experiment leads.

Printed with a circuit symbol.

Maximum voltage: 12 V

Maximum current: 5 A

Dimensions: 135x85x40 mm³

U29802

Ohm's Law Apparatus in 3B Box

Classic set-up for verifying Ohm's law for a two-pole resistor. Inside a safe box with sockets for safety experiment leads. Printed with circuit symbols.

Maximum voltage: 12 V

Maximum current: 2 A

Dimensions: 135x85x40 mm³

U29806

Universal Holder on 3B Box

Universal holder for two-pole components (resistors, capacitors, diodes, LEDs) attached to a safe box for building simple electric circuits using safety experiment leads. Printed with a circuit symbol.

Dimensions: 135x85x40 mm³

U29528

"Simple Electric Circuit" Experiment

Set consisting of:

1x Battery holder in 3B Box

1x Knife-edge switch on 3B Box

1x E10 lamp socket on 3B Box

1x Set of 10 E10 bulbs

2x Pair of safety experiment leads, 75 cm

UL29510

LED Graetz Bridge in 3B Box

Bridge rectifier circuit consisting of four LEDs connected in Graetz configuration. Inside a safe box for building simple electric circuits using safety experiment leads. Printed with circuit symbols.

Maximum voltage: 12 V

Maximum current: 20 mA

Dimensions: 135x85x40 mm³

U29804

Unknown Resistors in 3B Box

Four unknown resistors which can be connected separately in two series circuits. Inside a safe box with sockets for safety experiment leads. Printed with circuit symbols.

Maximum voltage: 6 V

Maximum current: 200 mA

Dimensions: 135x85x40 mm³

U29807

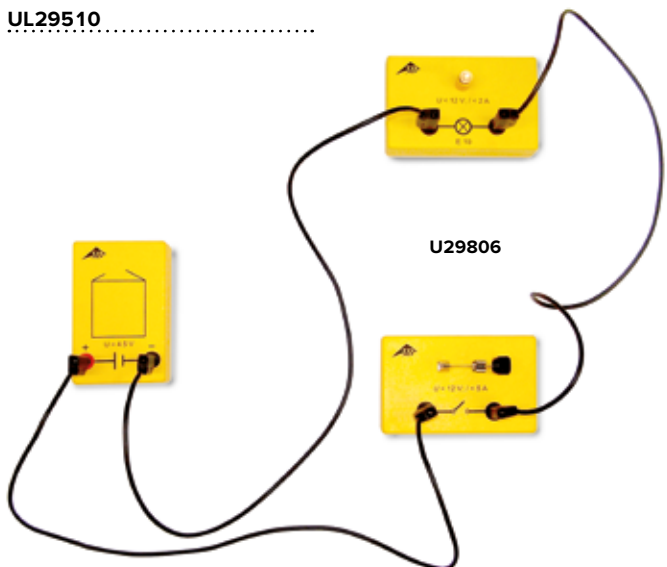



UE3020300
PDF online



U8551002

Resistance Bridge

Resistance Bridge used to measure resistances in bridge circuits and investigate voltage drops across wires. The device is only suitable for low voltages. It consists of a rail with a scale mounted at two points and a resistance wire stretched between two connecting sockets. A sliding contact on the resistance wire is used to set the resistance of the resultant two wire sections. A Wheatstone bridge circuit is configured to determine unknown resistances.

- Dimensions: approx. 1300x100x90 mm³
- Rail: approx. 30x30 mm²
- Scale: 0 – 1000 mm
- Scale divisions: mm
- Resistance wire: 1 m, 0.5 mm diam.
- Material: NiCr
- Resistance: 5.3 Ω
- Connection: 4 mm safety jacks
- Maximum permissible voltage: 8 V
- Maximum permissible current: 1.5 A

Additionally recommended:

- U11170 Zero Galvanometer CA 403**
- U11180 Resistance Decade 1 Ω**
- U11181 Resistance Decade 10 Ω**
- U11182 Resistance Decade 100 Ω**
- U51004 High-Precision Resistor 1 Ω**
- U51005 High-Precision Resistor 10 Ω**
- U117601-230 AC/DC Power Supply Unit 0 – 12 V, 3 A (230 V, 50/60 Hz) or**
- U117601-115 AC/DC Power Supply Unit 0 – 12 V, 3 A (115 V, 50/60 Hz)**

U8551002



U8492030

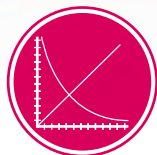

UE3020320
PDF online

Resistance Apparatus

Apparatus to investigate the dependency of electrical resistance on conductor length, conductor cross-section and material. Six wires are laid out side by side on a metal base and both ends connect to 4 mm sockets.

- Wire specimens: Constantan 1.0 mm diam.,
Constantan 0.7 mm diam. (2x),
Constantan 0.5 mm diam.,
Constantan 0.35 mm diam.,
Brass 0.5 mm diam.
- Wire lengths: 1000 mm
- Dimensions: approx. 1085x120x50 mm³
- Weight: approx. 1.35 kg

U8492030

Capacitor 2200 μF

- Capacitor in plastic housing with 4mm safety plugs.
- Capacitance: 2200 μF
- Tolerance: 20%
- Max. permissible voltage: 40 V
- Dimensions: approx. 122x70x50 mm³

U51012



U51012



U51005

High Precision Resistors

High precision resistors in plastic housing with 4 mm safety plugs.
Dimensions: approx. 122x70x50 mm³

Art. No.	Resistance	Tolerance	Load rating
U51004	1 Ω	1%	4 W
U51005	10 Ω	1%	4 W
U51006	100 Ω	1%	4 W
U51007	1 kΩ	1%	4 W
U51008	10 kΩ	1%	4 W
U51009	100 kΩ	1%	1 W
U51013	300 kΩ	5%	1 W
U51010	1 MΩ	1%	1 W
U51011	10 MΩ	1%	1 W



U11185

Resistance Decade, 1 Ω – 10 k Ω

Four resistance decades in a single housing, can be used individually or in combination, e.g. for setting up a Wheatstone bridge. Can be set using control knob, with decade scale.

Output: via 4 mm safety sockets
 Max. current: 700 mA (1 Ω – 10 Ω),
 200 mA (10 Ω – 100 Ω),
 70 mA (100 Ω – 1 kΩ),
 20 mA (1 kΩ – 10 kΩ)

Accuracy: 1%
 Dimensions: approx. 310x90x80 mm³
 Weight: approx. 1 kg

U11185



U17350 – U17357

Rheostats

Slide-contact resistors of high current-bearing capacity in housings that are safe to touch, for experiments with safety low voltage circuits, to be used as continuously variable resistors or voltage dividers. With built-in earth sockets.

Resistance tolerance: 10% from nominal value
 Max. permissible power: 320 W (continuous operation),
 640 W (max. 15min)

Max. permissible voltage: 600 V
 Terminals: 4 mm safety sockets
 Dimensions: approx. 446x93x150 mm³
 Weight: approx. 2.85 kg to 3.25 kg

Art. No.	Resistance	Max. current rating (continuous)	Max. current rating (15 min)
U17350	1 Ω	18 A	25 A
U17351	3.3 Ω	10 A	12 A
U17352	10 Ω	5.7 A	8 A
U17353	33 Ω	3.1 A	4.4 A
U17354	100 Ω	1.8 A	2.5 A
U17355	330 Ω	1 A	1.4 A
U17356	1000 Ω	0.57 A	0.8 A
U17357	3300 Ω	0.31 A	0.44 A



U11190 – U11191

Capacitance Decades

Capacitance decades which can be mechanically connected to one another. With colour-coded safety sockets and control knob for setting capacitances in 10 steps. Includes 25 cm safety patch cord.

Nominal voltage: 350 V DC
 Connections: 4 mm safety sockets
 Dimensions: approx. 72x72x90 mm³
 Weight: approx. 220 g

Art. No.	Measurement range	Step size	Accuracy
U11190	0.01 μF – 0,1 μF	0.01 μF	2%
U11191	0.1 μF – 1 μF	0.1 μF	2%

Resistance Decades

Resistance decades which can be mechanically connected to one another, e.g. in order to assemble a Wheatstone bridge. With colour-coded safety sockets and control knob for setting measurement resistances in 10 steps. Includes 25 cm safety patch cord.

Connections: 4 mm safety sockets
 Dimensions: approx. 72x72x90 mm³
 Weight: approx. 220 g

Art. No.	Measurement range	Step size	Max. current	Accuracy
U11180	0.1 Ω – 1 Ω	0.1 Ω	1 A	1% ±5 mΩ
U11181	1 Ω – 10 Ω	1 Ω	750 mA	1% ±5 mΩ
U11182	10 Ω – 100 Ω	10 Ω	250 mA	0.5%
U11183	100 Ω – 1 kΩ	100 Ω	75 mA	0.5%
U11184	1 kΩ – 10 kΩ	1 kΩ	25 mA	0.5%



U11180 – U11184

Experiment Topics:

- Assembly of a bell circuit
- Assembly of a relay
- Assembly of a bimetallic switch circuit

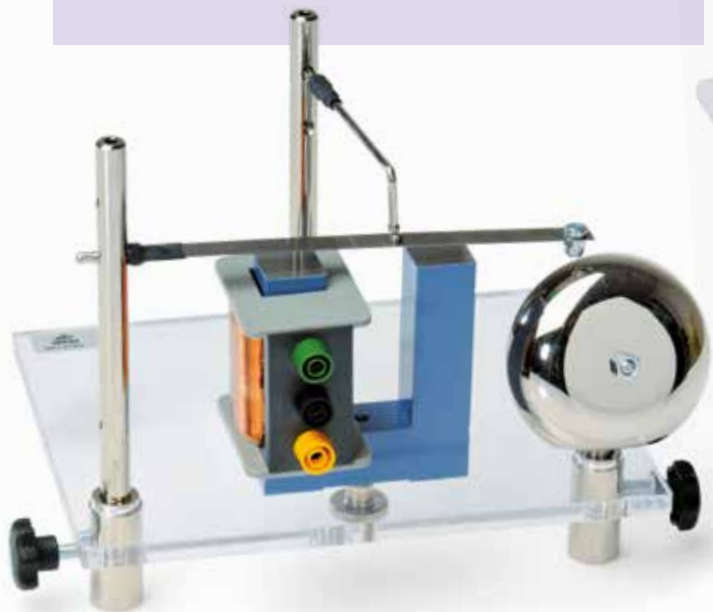

U8497700

Assembly Kit "Bell, Relay and Bimetallic Switch"

Equipment kit comprising materials to assemble electromagnetic switches and bimetallic switches.

Base plate: approx. 200x140x40 mm³
 Weight: approx. 1.6 kg

Contents:

- 1 Stand plate with 3 clamps
- 1 Bell, 70 mm in diameter
- 2 Contact rods with three 4 mm cross holes
- 1 Leaf spring with connector
- 1 Bimetallic strip with connector
- 1 Armature with connector
- 1 Contact pin with connector
- 1 U-core, 20x20 mm²
- 1 Coil, 800 turns

U8497700

Additionally required:

- Bulb, 12 V, 25 W, Type E14**, to replace blown components
- U8495320 Lamp Socket E14**
- U33300-230 Transformer with Rectifier (230 V, 50/60 Hz)**
or
- U33300-115 Transformer with Rectifier (115 V, 50/60 Hz)**

Inductance Decade

Variable inductance decade in impact-resistant plastic housing. This series incorporates mechanically stable components, a slide switch for setting measurement ranges and 4-mm safety sockets to ensure that all connections are safe.

Measuring range: 10 μH – 111.1 mH
 Increment: 10 μH
 Accuracy: 5%
 Number of decades: 4
 Limiting values: max. 100 mA AC/DC
 Dimensions: 140x190x80 mm³
 Weight: 450 g

U118201



U118201

U118211

Capacitance Decade

Capacitance decade in impact-resistant plastic housing. This series incorporates mechanically stable components, a slide switch for setting measurement ranges and 4-mm safety sockets to ensure that all connections are safe.

Measuring range: 100 pF – 111.1 μF
 Increment: 100 pF
 Accuracy: 5%
 Number of decades: 5
 Limiting values: max. 50 V DC
 Dimensions: 140x190x80 mm³
 Weight: 350 g

U118211

Experiment Topics:

- Ohm's law
- Parallel resistor circuits
- Series resistor circuits
- Unknown resistance
- Potentiometers
- Voltage dividers with no load
- Voltage dividers with load
- Discharge of a capacitor
- Bridge rectifiers
- Half-wave rectifiers
- Characteristic curve for a lamp
- Characteristic curve for an LED
- Characteristic curve for a silicon diode
- Characteristic curve for a zener diode
- LC parallel resonant circuit
- LC series resonant circuit
- RLC series resonant circuit

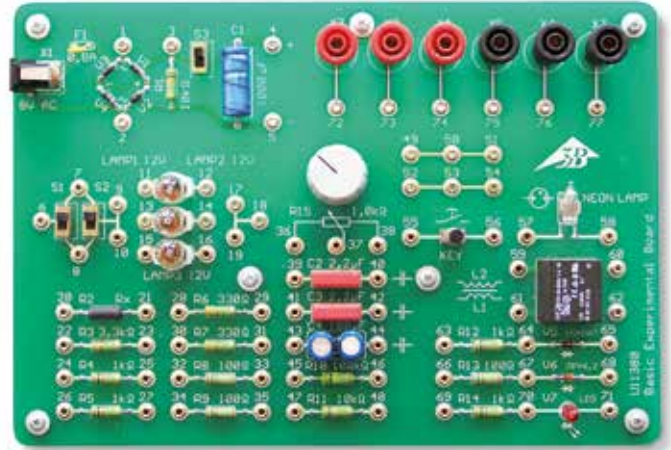

U11380-230 / U11380-115

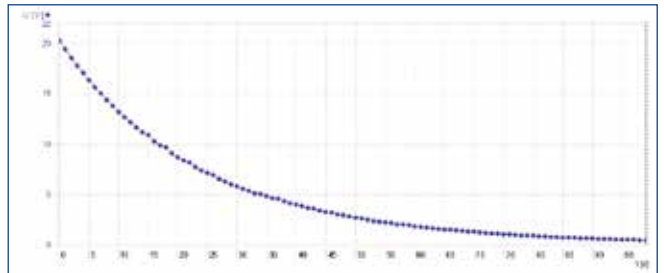

Discharge curve of a capacitor

Basic Experiment Board

Experiment board with basic circuits for electricity and electronics: circuit components, Ohm's law, Kirchhoff's laws, rheostat and potentiometer circuits, two way switching, charging and discharging curves of a capacitor, inductive effects in DC and AC circuits. Simple semiconductor circuits for determining diode characteristics, rectifier circuits, filter factors. The components can be interconnected via 2 mm sockets using jumpers and experiment leads. Six 2 mm/4 mm safety socket adaptors are provided for connecting 4 mm experiment leads.

Contents:

- 10 Leads (5 red and 5 blue) with 2 mm plugs, 20 cm long
- 10 Jumpers
- 1 Plug-in power supply 8 V AC/500 mA
- 1 board with the following electronic components:
 - 13 0.5 W resistors ranging from 100 Ω – 100 k Ω
 - 1 Potentiometer, 1 k Ω
 - 3 Filament lamps, 12 V
 - 2 Slide switches
 - 5 Capacitors (2x 2.2 μ F, 1x 100 μ F [bipolar], 1x 1000 μ F)
 - 5 1 A rectifier diodes
 - 1 Zener diode
 - 1 Red light emitting diode
 - 1 Neon fluorescent light
 - 1 Transformer, 12 V
- Dimensions: approx. 233x160 mm²

Basic Experiment Board (230 V, 50/60 Hz)

U11380-230

Basic Experiment Board (115 V, 50/60 Hz)

U11380-115

Additionally recommended:

- U17450 Analogue Multimeter AM50
- or
- U11310 3B NETlab™
- U11300-230 3B NETlog™ (230 V, 50/60 Hz)
- or
- U11300-115 3B NETlog™ (115 V, 50/60 Hz)
- U8533600-230 Function Generator FG 100 (230 V, 50/60 Hz)
- or
- U8533600-115 Function Generator FG 100 (115 V, 50/60 Hz)

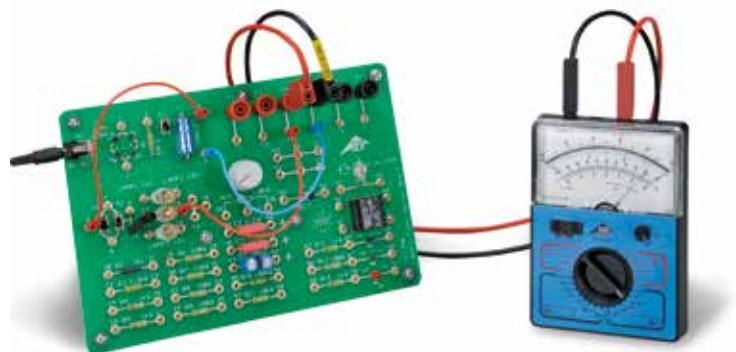

Measurement of the discharge of a capacitor



UE3050400
PDF online



Measurement of the discharge of a capacitor



Characteristic curve for a zener diode

Plug-in Board and Components for Building Electrical and Electronic Circuits in Demonstrations or Students' own Experiments



UE3050101
UE3050321
PDF online

Plug-in board with components to build a power controller

Plug-in Board for Components

Plug-in board for assembling electrical and electronic circuits using components in plug-in housings. Features 4-mm sockets on the front and rear, each internally connected to a square of 9 sockets plus two continuous serial layouts each with 12 sockets. Two adjacent plug-in boards can be connected together via plug-in components to make a board that is twice as big.

Connector squares: 16 complete squares and four half-squares

Socket separation: 19 mm from edge to edge of connector squares
50 mm from centre to centre of connector squares

Dimensions: 300x200x24 mm³

U33250

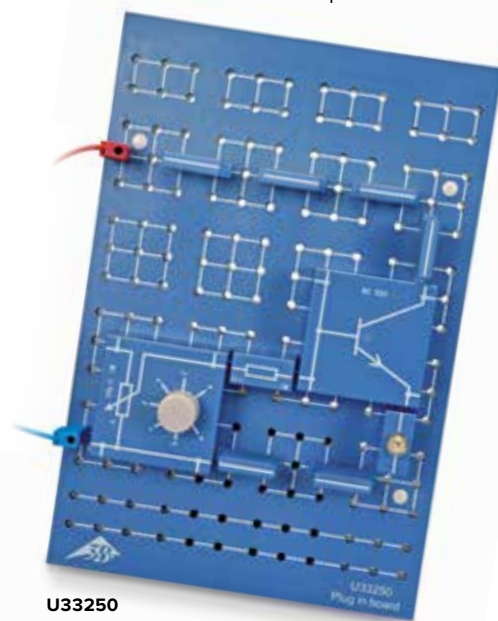

U33250

Pick out the individual components for your circuit yourself. Ask us about bulk discounts, even when ordering a mix of components in large numbers.

Components in Plug-in Housings with Two Plugs Separated by 19 mm

Capacitors

Art. No.	Capacitance	Tolerance	Max. tension
U333055	100 pF	20%	160 V
U333056	470 pF	20%	160 V
U333057	1 nF	20%	100 V
U333058	2.2 nF	20%	160 V
U333059	4.7 nF	2.5%	100 V
U333060	10 nF	20%	100 V
U333051	22 nF	20%	100 V
U333052	47 nF	5%	100 V
U333053	0.22 μF	5%	250 V
U333054	4.7 μF	5%	63 V
U333061	0.1 μF	20%	100 V
U333062	0.47 μF	20%	100 V
U333063	1 μF	20%	100 V
U333064	2.2 μF	5%	63 V



U333018



U333055



U333067

Electrolytic Capacitors

Art. No.	Capacitance	Tolerance	Max. tension
U333065	10 μF	20%	35 V
U333066	47 μF	20%	35 V
U333067	100 μF	20%	35 V
U333068	470 μF	20%	16 V
U333106	1000 μF	20%	35 V

Linear Resistors

Art. No.	Resistance	Tolerance	Max. power
U333011	1 Ω	5%	2 W
U333012	10 Ω	5%	2 W
U333013	10 Ω	5%	10 W
U333014	5.1 Ω	5%	2 W
U333015	22 Ω	5%	2 W
U333016	47 Ω	5%	2 W
U333017	68 Ω	5%	2 W
U333018	100 Ω	5%	2 W
U333019	150 Ω	5%	2 W
U333020	220 Ω	5%	2 W
U333021	330 Ω	5%	2 W
U333022	470 Ω	5%	2 W
U333023	680 Ω	1%	2 W
U333024	1 kΩ	5%	2 W
U333025	1.5 kΩ	5%	2 W
U333026	2.2 kΩ	5%	2 W
U333027	3.3 kΩ	5%	2 W
U333028	4.7 kΩ	5%	2 W
U333029	6.8 kΩ	5%	2 W
U333030	10 kΩ	5%	0.5 W
U333031	15 kΩ	5%	0.5 W
U333032	22 kΩ	5%	0.5 W
U333033	33 kΩ	5%	0.5 W
U333034	47 kΩ	5%	0.5 W
U333035	68 kΩ	1%	0.5 W
U333036	100 kΩ	5%	0.5 W
U333037	220 kΩ	5%	0.5 W
U333038	330 kΩ	5%	0.5 W
U333039	470 kΩ	5%	0.5 W
U333040	1 MΩ	5%	0.5 W
U333041	10 MΩ	5%	0.5 W



U333070



U333074



U333072



U333096



U333091



U333098

LEDs

Art. No.	Colour	Orientation
U333070	red	upward facing
U333079	green	upward facing
U333080	red	side facing
U333107	yellow	upward facing
U333108	infrared	side facing

Zener Diodes

Art. No.	Type	Max. power dissipation
U333073	ZPD 3.3	0.5 W
U333074	ZPD 9.1	0.5 W
U333075	ZPD 6.2	0.5 W
U333076	ZPY 5.6	1.3 W
U333077	ZPY 8.2	1.3 W
U333078	ZPD 18	0.5 W

Semiconductor Diodes

Art. No.	Type	Material	Cut-off voltage	Max. long-term current
U333072	1N 4007	Si	1000 V	1 A
U333069	BY 255	Si	1300 V	3 A
U333071	AA 118	Ge	90 V	50 mA

Thermistors Max. temperature:

Art. No.	Type	Resistance (25°C)	Resistance (100°C)
U333049	NTC	2.2 kΩ	120 Ω
U333050	PTC	100 Ω	

Voltage Dependent Resistor

Characteristic voltage at 1 mA:
8 V (DC) approx.

U333109

Phototransistor BPX43

Phototransistor for use as light-sensitive switch.

Range of sensitivity: 450 – 1100 nm

Max. operating voltage: 32 V

Max. current load: 100 mA

Max. Power dissipation: 0.3 W

U333110

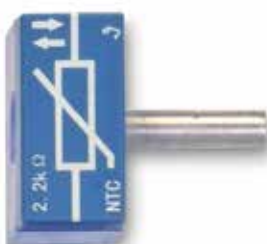

U333049



U333111



U333048



U333081



U333110

Single-Pole Push-Button Switches

Art. No.	Type
U333096	Normally open
U333097	Normally closed

Coils

Art. No.	Type	Inductance
U333091	Coil	10 mH
U333092	High-Frequency Coil	33 mH

Single-Pole Rocker Switch

U333098

Micromotor 1.5 V DC

Miniature motor with gearbox permanently fixed to the side.

Operating

voltage: 0.5 – 1.5 V DC

Gear ratio: 40 : 1

U333103



U333103

LDR 05 Photoresistor

Resistance: 100 Ω (bright light) – 10 MΩ (dark)

Max. power

dissipation: 0.2 W

U333048

BR 100 Diac

BR100 diac in a plug-in housing printed with the appropriate circuit symbol.

Breakdown voltage: 32 V approx.

Breakdown current: 50 μA approx.

U333081

Silicon Photovoltaic Cell BPY47P

Range of sensitivity: 420 – 1060 nm

Max. sensitivity: 820 nm

Open-circuit voltage: 0.45 V

Short-circuit current: 1.4 mA

Max. current load: 100 mA

Max. Power dissipation: 0.3 W

U333111

Additionally recommended:

Holder for Plug-in Components

U8557220

Components in Plug-in Housings with Four Plugs Separated by 50 mm



U333047



U333082



U333083



U333114

Potentiometers

Art. No.	Resistance	Max. power
U333042	220 Ω	1 W
U333043	470 Ω	1 W
U333044	1 kΩ	1 W
U333045	10 kΩ	1 W
U333046	4.7 kΩ	1 W
U333047	100 kΩ	1 W

Transistors

Art. No.	Type	Current gain	Power dissipation
U333082	NPN BD137	40 – 250	5 W
U333112	NPN BC140	100 – 250	0.8 W
U333084	NPN BC550	420 – 800	0.5 W
U333083	PNP BD138	40 – 250	5 W
U333113	PNP BC160	100 – 250	3.7 W
U333085	PNP BC560	420 – 800	0.5 W
U333114	Darlington TIP 162	approx. 200	max. 3 W



U333086

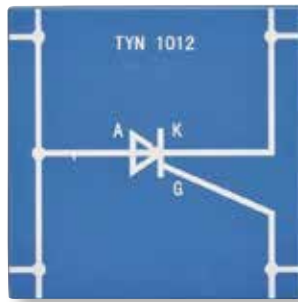

U333087



U333088

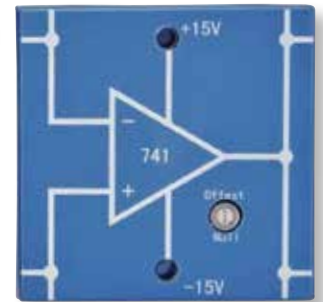

U333089

BF 244 Field Effect Transistor

Type: BF244,
N-channel-FET
Power dissipation: 300 mW

U333086

TYN 1012 Thyristor

Type: TYN 1012,
N-channel FET
Cut-off current: 8 A

U333087

BT 137/800 Triac

Type: BT 137/800
Cut-off current: 3 A

U333088

LM 741 Operational Amplifier

Operating voltage: ±15 V DC
Output current: 15 mA

U333089

Double-Pole Change-Over Switch

Mechanical rocker switch with two switch positions on a square plug-in housing printed with the appropriate circuit symbol. Internal mechanical coupling with two change-over switches for each of the three switch positions to be reproduced in two circuits.
Switch functions: 2 x ON-OFF, 2 x OFF-ON, 2 x ON-OFF-ON, 2 x Change-over

U333099

Relay with Change-Over Contacts

Control voltage: 4–16 V DC
Coil resistance: 150 Ω approx.
Maximum switched power: 50 VA

U333100

Low-Frequency Transformer, 1:2

U333090

Single-Pole Change-Over Switch

U333101



U333099



U333100

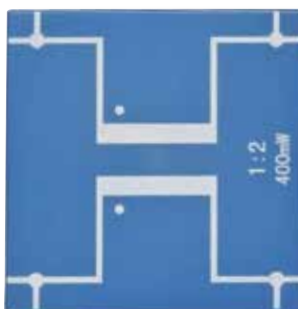

U333090

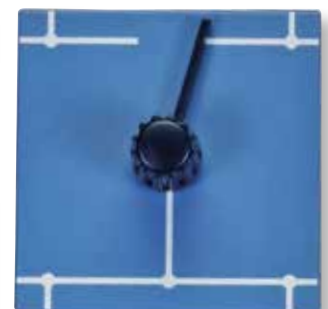

U333101



U333095



U333093



U333102

E 10 Socket

Art. No.	Type
U333094	Socket side facing
U333095	Socket upward facing

Additionally required:

E10 bulb from **U29512, U29513, U29514, U29515, U29516, U29517, U29589, U29590, U29591, U29592** or **U29593**

Set of 10 Jumpers

Set of 10 jumpers with printed lines showing the connection between the two plugs, for assembling circuits on the plug-in component board (U33250).
Max. permitted current: 25 A
Plug separation: 19 mm

U333093

Battery Holder

Open housing with connectors for type IEC R 20 1.5-V batteries.
Plugs: 2
Plug separation: 50 mm

U333102

Experiment topics

- Characteristics of a semiconductor diode
- Characteristic of an LED
- Characteristic of a zener diode
- Transistors
- Characteristics of a transistor
- LDR photoresistor (light dependent resistor)
- Thyristors in DC circuits
- Temperature response of NTC and PTC thermistors
- Delayed switching processes
- Characteristics of a field effect transistor
- Check for mains hum
- Bridge rectifiers



Set of Components for Electronics Experiments

Assortment of components for basic experiments in the area of electronics using a component plug-in board. In a storage case with matching foam inlay.

Contents:

- 1 Set of 10 Jumpers
- 1 Resistor 100 Ω, 2W
- 1 Resistor 470 Ω, 2 W
- 1 Resistor 1 kΩ, 2 W
- 1 Resistor 4.7 kΩ
- 1 Resistor 10 kΩ, 0.5 W
- 1 Resistor 47 kΩ, 0.5 W
- 1 Electrolytic Capacitor 100 μF, 35 V
- 1 Electrolytic Capacitor 470 μF, 16 V
- 1 E 10 Socket, socket upward facing
- 1 Set of 10 bulbs, 12 V; 100 mA
- 1 Set of 10 bulbs, 4 V; 40 mA
- 1 Single-Pole Rocker Switch
- 1 Single-Pole Push-Button Switches, normally open
- 1 Single-Pole Push-Button Switches, normally closed
- 4 Si-Diodes 1N 4007
- 1 Ge-Diode
- 1 Zener Diode ZPD 6.2
- 1 LED green
- 1 LED, red

- 1 LDR 05 Photoresistor
- 1 NTC Thermistor 2.2 kΩ
- 1 PTC Thermistor 100 Ω
- 1 Potentiometer 220 Ω, 3 W
- 1 NPN Transistor BD 137
- 1 PNP Transistor BD 138
- 1 BF 244 Field Effect Transistor
- 1 TYN 1012 Thyristor
- 1 Single-Pole Change-Over Switch
- 1 Set of earpiece headphones

U8557280

Additionally required:

U33250 Plug-in Board for Components

U8557330 Analogue Multimeter ESCOLA 30

U13800 Set of 15 Experiment Leads, 75 cm

U117601-230 AC/DC Power Supply 0 – 12 V, 3 A (230 V, 50/60 Hz) or

U117601-115 AC/DC Power Supply 0 – 12 V, 3 A (115 V, 50/60 Hz)

Experiment Topics:

- Measurement of charging and discharging curves for pairs of RC components
- Determination of ratings of integrated resistors
- Determination of ratings of integrated capacitors
- Determination of rating of an electrolytic capacitor
- Estimation of bounce times

Charge and Discharge Apparatus

Compact equipment for recording charging and discharging curves for capacitors at individual points. Includes 12 V AC plug-in power supply. The charger and discharger consists of three units in a single housing: a voltage comparator, a digital counter and three resistor-capacitor pairs. The comparator compares the charging and discharging voltages with a set comparison voltage, which can be selected from any of 11 values between 0 to 10 V. The digital counter indicates the charging and discharging times for the capacitor as soon as the set comparison voltage is attained. In addition there are pairs of sockets for connecting an external resistor and an external capacitor.

Internal capacitor: 2067 μF
 Internal resistors: 2.2 k Ω , 5.1 k Ω , 10 k Ω
 Digital counter: 4-digit, quartz controlled
 Maximum value: 200 s
 Resolution: 100 ms
 Power supply: 12 V AC, 2000 mA plug-in power supply
 Dimensions: 260x220x55 mm³ approx.
 Weight: 1700 g, including plug-in power supply

U10800-230
 U10800-115



Charge and Discharge Apparatus (230 V, 50/60 Hz)

U10800-230

Charge and Discharge Apparatus (115 V, 50/60 Hz)

U10800-115

Additionally recommended:
U333106 Capacitor 1000 μF
U333028 Resistor 4.7 k Ω
U333030 Resistor 10 k Ω
U333032 Resistor 22 k Ω

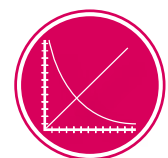

UE3050105
 PDF online



Measurement at an external RC pair

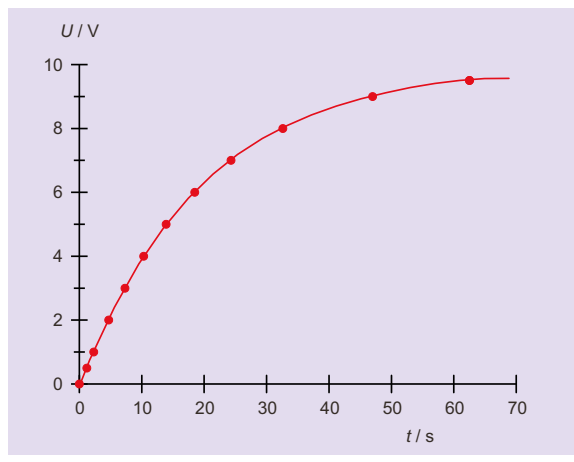

Charging curve

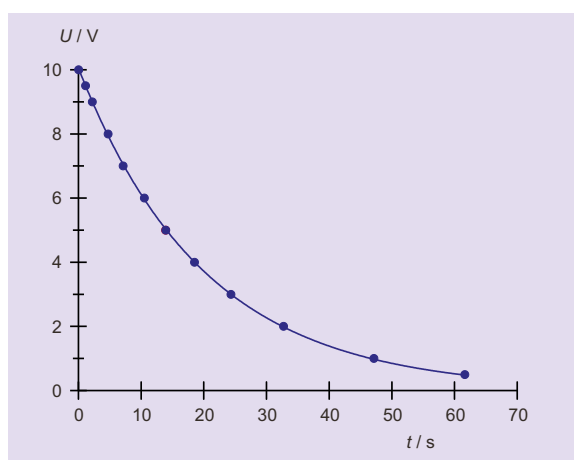

Discharging curve

Experiment Topics:

- Measurement at galvanic voltage sources
- Daniell cell, series and parallel circuits
- Electrochemical potentials (voltage sequence)
- Determination of the standard potentials of different metals and non metals
- How potentials depend on concentration
- How potentials depend on temperature
- Charge and discharge of a steel accumulator
- Leclanché cell
- Measurement of pH values



U11110

Electrochemistry Case

A complete equipment set in a case for basic experiments on electrochemistry. A cell block made of tough plastic, which can be unscrewed into two halves for ease of cleaning, allows four galvanic cells to be connected in parallel. A piece of filter paper stretched between the two halves of the cell acts as a diaphragm. Includes a handy, high-resistance meter for measuring potential differences with very little current and measuring pH values with the help of the supplied pH measuring probe.

Measurement device:

7 segment display:	3 digit
Height:	13 mm
Voltage ranges:	2 V DC and 20 V DC
Resolution:	1 mV
Input resistance:	200 MΩ
pH measuring range:	0.0 – 14.0 pH
Power supply:	Plug-in power supply, 12 V/0.5 A (as supplied) or 9-V block battery
Dimensions:	approx. 175x105x55 mm ³

pH Combined Electrode

pH combined electrode with shaft made of plastic with a BNC plug and highly flexible cable.

Length of cable:	approx. 1 m
Dimensions:	approx. 120 mm x 12 mm diam.

U11111

U11111

Contents:

- 1 foam lined case
- 1 measurement device
- 1 pH combined electrode with BNC plug
- 1 plug-in power unit 12 V DC / 500 mA for 115/230 V AC mains voltage
- 1 Cell block, fitted with filter paper
- 2 Ag-electrodes, 42x28 mm²
- 1 Pt-electrode, 42x28 mm²
- 4 Zn-electrodes, 42x28 mm²
- 2 Fe-electrodes, 42x28 mm²
- 2 C-electrodes, 42x28 mm²
- 2 Al-electrodes, 42x28 mm²
- 2 Ni-electrodes, 42x28 mm²
- 4 Cu-electrodes, 42x28 mm²
- 1 Mg-electrode, 42x28 mm²
- 1 set of filter papers (50 units)
- 1 Sanding block for cleaning electrodes
- 3 experiment cables with crocodile clips, 20 cm, red
- 3 experiment cables with crocodile clips, 20 cm, blue
- 1 experiment cable with crocodile clip and 2 mm plug, 30 cm, red
- 1 experiment cable with crocodile clip and 2 mm plug, 30 cm, blue
- 2 graduated plastic beakers, 25 ml
- 2 drip pipettes with suction bulbs
- 1 Storage box with loose insert
- 1 operating instructions on CD-ROM

U11110

Additionally required:

Chemicals

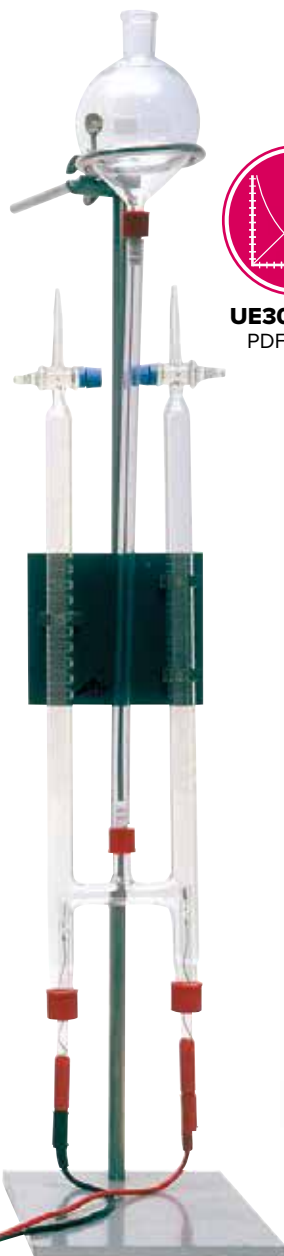

U14332

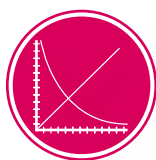
UE3020700
 PDF online

U58010

Daniell Cell

Galvanic cell (Daniell cell) named after John Frederic Daniell for studying the properties of an electrochemical cell. The Daniell cell consists of a cylindrical zinc and copper electrode, a clay vessel and a battery glass. Filled with cell electrolyte the Daniell cell supplies a voltage of approx. 1.1 volts. The cell is delivered empty.

Connections: 4 mm jacks
 Dimensions: approx. 105 mm x 65 mm diam.
 Suitable filling: Copper sulphate solution (CuSO_4), 10% concentration,
 Zinc sulphate solution (ZnSO_4), 10% concentration

U14331



U58011

U14331

Carbon Electrodes

Pair of graphite electrodes for use with the Hofmann's voltameter S (U58010) for the analysis of ammonia solutions, solutions of table salt or other solutions with chloride radicals.

U58011

Hofmann's Voltmeter

Apparatus for electrolysis of water, the quantitative determination of the gases formed and establishing Faraday's laws. Consists of two scaled gas collection tubes connected by flexible plastic hose with levelling bulb for pressure compensation and hence for the exact measurement of gas volumes, on stand with retaining plate. GL threads provide secure mounting for electrodes.

Dimensions: approx. 800x150 mm²
 Baseplate area: approx. 250x160 mm²
 Rod: 750 mmx12 mm diam.
 Retaining plate: approx. 120x110 mm²

Contents:

- 1 gas collection tubes
- 2 platinum electrodes with 4 mm sockets
- 1 plastic hose with levelling bulb
- 1 stand ring for holding levelling bulb
- 1 universal bosshead
- 1 stand baseplate with rod and retaining plate

U14332

Additionally recommended:

U33020-230 DC Power Supply, 0 – 20 V, 0 – 5 A
 (230 V, 50/60 Hz)

or

U33020-115 DC Power Supply, 0 – 20 V, 0 – 5 A
 (115 V, 50/60 Hz)

Hofmann's Voltmeter S

Hofmann's voltameter is used for determining the chemical composition of water by volume. The apparatus consists of three vertical glass tubes connected to each other at the bottom. Taps at the top ends of the outside tubes are closed whilst the inner cylinder is open at the top to allow the addition of water via a reservoir. Gold sheet electrodes are fitted to the lower ends of the outside tubes and connected to a low-voltage power supply. The proportion of hydrogen and oxygen produced by electrolysis from the water can be read from the graduations on the side tubes. By opening the taps at the top of the tubes, gases can be collected for analysis. Carbon electrodes are also available for analysis of solutions where gold is unsuitable.

Dimensions: approx. 580x150 mm²
 Stand base, A-shaped: 115 mm leg length
 Operating voltage: 4 – 12 V DC

U58010

Additionally required:

U33020-230 DC Power Supply, 0 – 20 V, 0 – 5 A
 (230 V, 50/60 Hz)

or

U33020-115 DC Power Supply, 0 – 20 V, 0 – 5 A
 (115 V, 50/60 Hz)

Additionally recommended:

U58011 Carbon electrodes

Equipment Set for Electrochemistry

Set for measuring electrochemical potentials of various metals in experiments intended for students. Includes digital multimeter.

Trough: approx. 85x70x45 mm³
 Electrodes: approx. 76x40 mm²

Contents:

- 1 flat trough
- 1 copper plate
- 1 zinc plate
- 1 iron plate
- 2 nickel plates
- 1 aluminum plate
- 2 electrolyte-carbon plates
- 1 digital multimeter with 2 cables with crocodile clamps

U11100

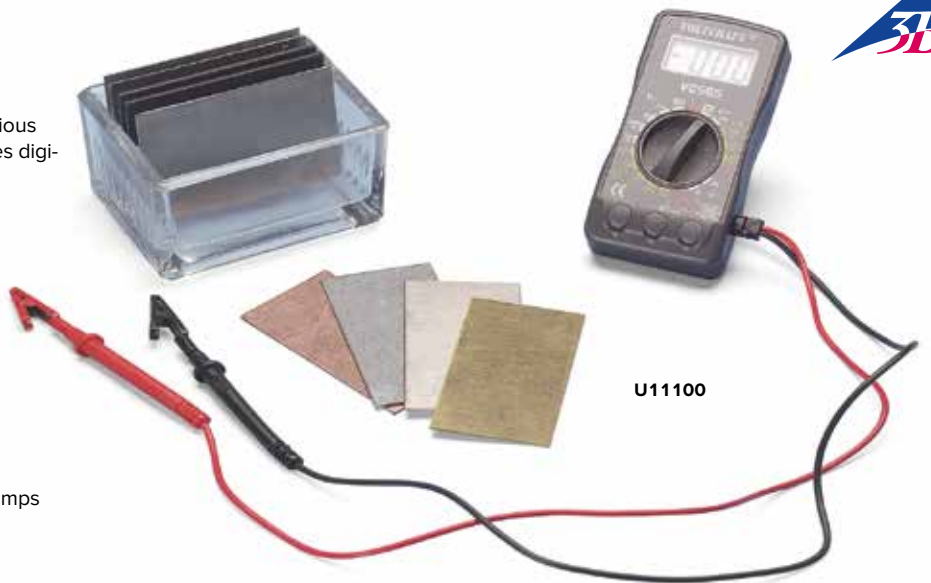

Electrode plates (not shown)

Spare electrodes for the electrochemistry equipment set (U11100).
 Dimensions: approx. 76x40 mm²

Art.-No.	Material
U11101	Set of 10 Copper Plates
U11102	Set of 10 Zinc Plates
U11103	Set of 10 Iron Plates
U11104	Set of 5 Nickel Plates
U11105	Set of 10 Aluminum Plates
U11106	Set of 5 Carbon Plates

Leclanché Cell

This model of a dry battery was invented by the French chemist Georges Leclanché in the 1860s. It consists of a cylindrical zinc electrode, a rod shaped carbon electrode, a clay vessel and a battery glass. Filled with cell electrolyte, the Leclanché cell supplies a voltage of approximately 1.5 volts. The cell is delivered empty.

Connections: 4 mm jacks
 Dimensions: approx. 175 mm x 65 mm diam.

Suitable filling: Ammonium chloride solution (NH₄Cl), approx. 20% concentration



U14330

Experiment Topics:

- Conductors and non-conductors
- Determining electrolytes
- Distinguishing between 5 typical electrolytes

Conductivity Tester

Easy to use meter for determining conductivity of electrolytes (in water courses) and distinguishing between distilled water, rain water, tap water, brine and sea water, as well as between acids and alkalis. The display indicates the levels "very low", "low", "medium", "high" and "very high" and has LED backlighting. Even the very low conductivity of distilled water is displayed. The device is protected against spray and can therefore be used without difficulty in the open air. It can be powered either by a 9-V block battery (not included) or by the supplied 12-V/500-mA plug-in power supply.

Measuring ranges: 2 – 20 μS/cm (very low),
 20 – 100 μS/cm (low),
 100– 500 μS/cm (medium),
 500 – 3000 μS/cm (high),
 > 3000 μS/cm (very high)

Dimensions: 85x35x170 mm³
 Battery capacity: 10 hours approx.

U11065

Additionally required:
U11066 Conductivity Electrode



U11065

Conductivity Electrode

Conductivity electrode for use with conductivity tester (U11065). With platinum wires and 0.8 m of cable tipped by two 4-mm plugs.
 Cell constant: 1/cm approx.
 Dimensions: 130 mm x 15 mm diam.

U11066

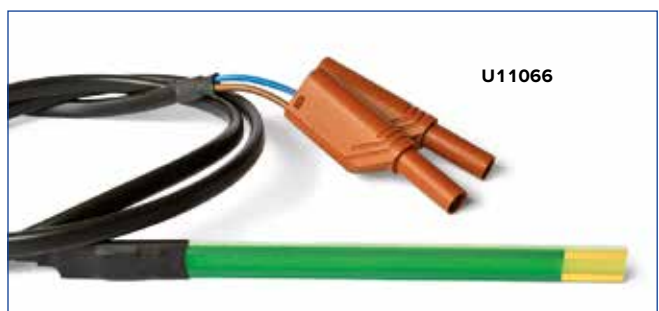

U11066

Magnetic Equipment Set

A selection of various magnets for introducing the subject of magnetism. Complete with a specially moulded storage tray.

Contents:

- 3 AlNiCo round magnets: 12 mm, 19 mm, 24 mm diam.
- 1 AlNiCo horseshoe magnet, 25 mm long
- 1 Chromium-steel horseshoe magnet, 100 mm long
- 2 Chromium-steel bar magnets, 100 mm x 6 mm diam.
- 2 Bar magnets in a protective plastic case, 80 mm long
- 5 Iron ring magnets, 25 mm diam.
- 5 Iron magnets, 19x19x5 mm³
- 1 Natural magnet
- 4 Coloured magnetic foils, 50x50 mm²
- 2 Drawing compasses, 19 mm diam.
- 2 Drawing compasses, 16 mm diam.

U19555



U19555

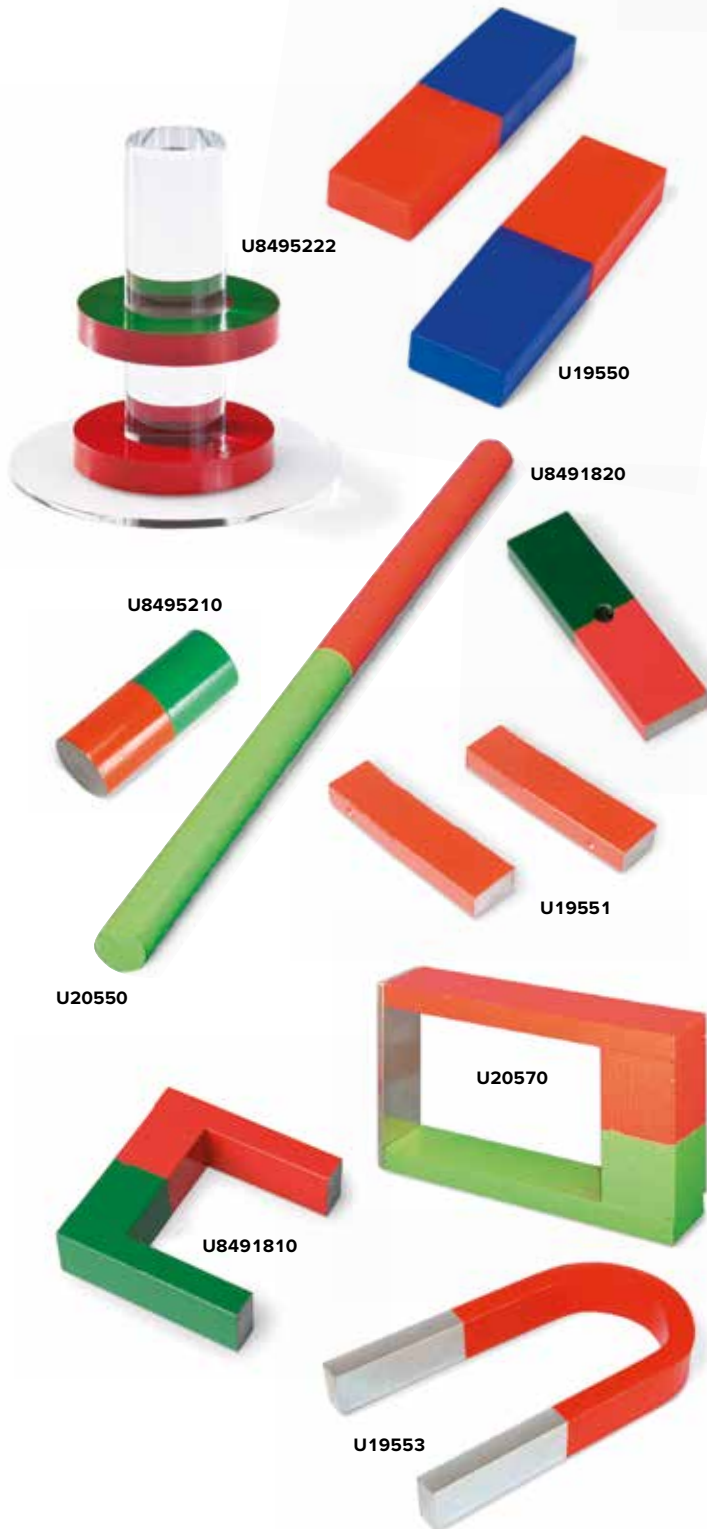

U8495222

U19550

U8491820

U8495210

U19551

U20550

U20570

U8491810

U19553

Pair of Bar Magnets, 80 mm

Pair of bar magnets with poles marked red and blue. In plastic protective cover.
 Dimensions: approx. 80x22x10 mm³

U19550

Cylindrical Bar Magnet 50x20

Round bar magnet with poles marked red and green.
 Dimensions: approx. 50 mm x 20 mm diam.

U8495210

Cylindrical Bar Magnet 200x10

Round bar magnet with poles marked red and green.
 Dimensions: approx. 200 mm x 10 mm diam.

U20550

Horseshoe Magnet, 70 mm

Horseshoe shaped AlNiCo magnet. Poles marked red and green.
 Pole area: approx. 20x10 mm²
 Distance between poles: approx. 50 mm
 Length of shank: approx. 70 mm
 Weight: approx. 400 g

U8491810

Horseshoe Magnet 130 mm, with Yoke

Horseshoe shaped magnet with yoke. Poles coloured red/green.
 Pull-off force of yoke: 250 N
 Pole spacing: approx. 60 mm
 Length: approx. 130 mm

U20570

Suspended Magnet

Apparatus for demonstrating repulsion forces between magnets. Two ring magnets facing each other with identical poles are placed onto a rod.
 Base: approx. 100 mm diam.
 Rod: approx. 100 mm x 30 mm diam.
 Weight: approx. 410 g

Contents:

- 1 Rod with Base
- 2 Ring magnets

U8495222

Bar Magnet, AlNiCo, 70 mm

AlNiCo bar magnet with poles marked red and green.
 Dimensions: approx. 70x20x8 mm³
 Weight: approx. 80 g

U8491820

Pair of Bar Magnets, AlNiCo, 60 mm, with Two Iron Yokes

Pair of AlNiCo bar magnets, red, with north pole marked. Including two iron yokes.
 Dimensions: approx. 60x15x5 mm³

U19551

Horseshoe Magnet 140 mm, with Yoke

Horseshoe shaped stainless steel magnet with yoke, poles coloured red and silver.
 Pole area: approx. 20x10 mm²
 Distance between poles: approx. 60 mm
 Length of shank: approx. 140 mm

U19553

Equipment Kit “Hysteresis Curve”

Apparatus for recording the magnetic flux density as a function of the magnetic field strength in different samples.

Dimensions of the

- iron samples: approx. 140 mm x 10 mm diam.
- Number of turns: 850
- Internal resistance: 3.2 Ω
- Inductance without core: 3.2 mH
- Dimensions: approx. 200x145x65 mm³
- Total weight: approx. 470 g

Contents:

- Base plate with coil and holder for Hall sensors
- 3 Material samples (Vacon 11, spring steel and silver steel)

U8557500

Additionally required:

U8533600-230 Function Generator FG 100 (230 V, 50/60 Hz)

or

U8533510-115 Function Generator FG 100 (115 V, 50/60 Hz)

Additionally recommended:

U11360 Magnetic Field Sensor 100 mT

U11300-230 3B Netlog™ (230 V, 50/60 Hz)

or

U11300-115 3B Netlog™ (115 V, 50/60 Hz)

U11310 3B NETlab™

Alternative:

U8533997 Magnetic Field Sensor, Axial/Tangential

U8533982 Teslometer E

U11175 Analogue Oscilloscope 2x30 MHz



U8557440



U19556

Soft-Iron Bars

Set of 5, non-magnetic soft-iron bars for magnetic induction experiments.

Dimensions: approx. 155 mm x 10 mm diam.

U19556

Lodestone

Unfinished, walnut-sized stone made of magnetic iron ore (magnetite).



U19557

U19557

Compass Magnet with Plastic Bowl

Very powerful neodymium magnet covered with a plastic case which can float on the surface of water and faces North South when it comes to rest. Complete with translucent plastic bowl marked with compass points.

Dimensions:

Magnet: 80 mm x 30 mm max diam.

Bowl: approx. 40 mm x 115 mm diam.

U19563



U19563

“Oersted’s Needle” Device

Compact and easy to understand apparatus to demonstrate Oersted’s experiment. An electric current passing through a piece of enamelled copper wire creates a magnetic field around the wire, which can deflect a magnetic compass needle from its normal position.

Dimensions of base: 200x80 mm²

Copper wire: 3 mm diam.

Electrical

connections: 4-mm safety sockets

Maximum

permissible current: 5 A

U29310

Additionally recommended:

U33020-230 DC-Power Supply 0 – 20 V, 0 – 5 A (230 V, 50/60 Hz) or

U33020-115 DC-Power Supply 0 – 20 V, 0 – 5 A (115 V, 50/60 Hz)



U29310



U8495245

Globe with Bar Magnet

Globe of the World with bar magnet along the axis of the Poles on an acrylic base, this demonstrates the shape of the Earth's magnetic field. A compass (U19561) or a magnetic field indicator (U8491900) can be seen to align at the surface of the globe in accordance with a magnetic field parallel to the lines of longitude. The inclination can also be determined using the magnetic field sensor.

Dimensions: 220x160x200 mm³
 Diameter (globe): approx. 120 mm
 Weight: approx. 340 g

U8495245

Additionally recommended:

- U8491900 Magnetic Field Indicator
- U19561 Compass

Magnetic Field Indicator

Bar magnet, with Poles identified by colour and free to turn in space, for three-dimensional mapping of magnetic fields. On agate gimbal bearings pivot allowing free rotation in space, small bar magnet with colour pole coding. The handle and cardanic suspension are made of plastic to alleviate any adverse effects on magnetic field.

Magnet: approx. 25x3x3 mm³
 Handle length: approx. 95 mm

U8491900

Experiment: Determination of the horizontal and vertical components of the Earth's magnetic field

Equipment:

- U8481500 Helmholtz Coils 300 mm
- U33020-230 DC Power Supply 0 – 20 V, 0 – 5 A (230 V, 50/60 Hz)

or

- U33020-115 DC Power Supply 0 – 20 V, 0 – 5 A (115 V, 50/60 Hz)

- U11806 Digital Multimeter P1035
- U8495258 Inclination Instrument E
- U17354 Rheostat P-100 Ω
- U138021 Set of 15 Safety Experiment Leads, 75 cm

U33020-230
 U33020-115



U17354

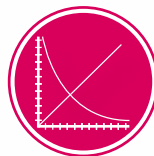

UE3030700
 PDF online



U11806

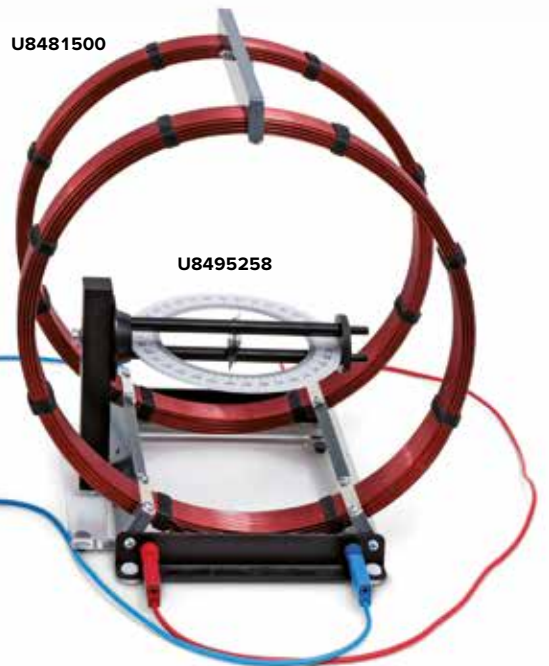

U8481500

U8495258

Determination of the horizontal and vertical components of the Earth's magnetic field

Compass

Compass in a stable housing, low friction needle bearing, including a compass card and angle scale.
 Scale division: 2°
 Diameter: approx. 45 mm

U19561

Magnetic Needle, 80 mm

Magnetic needle mounted on base with pivot point.
 Length: approx. 80 mm
 Height: approx. 110 mm

U216031



U19561



U216031

Inclination Instrument E

Instrument for measuring the inclination of the Earth's magnetic field and also for mapping the magnetic field of a current-carrying conductor. The agate bearings hold the magnetic needle which is mounted in a frame with reference circle. The frame is equipped with an additional reference circle. There are two 4 mm sockets included for the power supply.

Length of magnetic needle: approx. 100 mm
 Dimensions: approx. 180x100x220 mm³
 Weight: approx. 620 g

U8495258

Additionally recommended:

U33020-230 DC Power Supply 0 – 20 V, 0 – 5 A (230 V, 50/60 Hz)

or

U33020-115 DC Power Supply 0 – 20 V, 0 – 5 A (115 V, 50/60 Hz)



U8495258

Inclination Instrument

Instrument for measuring the inclination of the Earth's magnetic field and also for mapping the magnetic field of a current-carrying conductor. An aluminium conductor loop with 4 mm safety sockets, a magnetic needle with a pointed axle rotates on bearings above a full circle in transparent material with an angle scale, rotating around the horizontal axis and mounted on an acrylic base.

Diameter of circle: approx. 110 mm
 Length of magnetic needle: approx. 100 mm
 Strap length: approx. 150 mm
 Terminal: 4 mm safety sockets
 Base dimensions: approx. 100x90x185 mm³

U21900

Additionally recommended:

U33020-230 DC Power Supply 0 – 20 V, 0 – 5 A (230 V, 50/60 Hz)

or

U33020-115 DC Power Supply 0 – 20 V, 0 – 5 A (115 V, 50/60 Hz)



U21900

Set of 10 Tracing Compasses

Set of 10 compasses for tracing field lines. Aluminium housing, glazed on both sides. Markings for indicating compass directions.

Diameter: approx. 19 mm

U19562



U19562





U8491925

Three-Dimensional Magnetic Field Lines Device

Instrument for three-dimensional mapping of the magnetic field lines of a cylindrical bar magnet. The acrylic housing is filled with a special, highly viscous liquid and iron filings. After the magnet has been inserted into the central hole, the iron filings, which had previously been distributed randomly in the liquid, align themselves according to the direction of the field. An enclosed air bubble ensures that a good shake of the device causes the iron shavings to be evenly distributed.
 Diameter of the hole: approx. 21 mm
 Dimensions: approx. 120x110x110 mm³
 Weight: approx. 0.8 kg

U8491925

Additionally required:
U8495210 Cylindrical Bar Magnet 50x20 mm

U11451



U11452



Two-Dimensional Magnetic Field Line Apparatus

Demonstration apparatus for two-dimensional display of magnetic field lines in combination with an overhead projector. It consists of a transparent plastic vessel filled with a liquid containing magnetic powder. Magnets and an experiment manual in English are included.
 Dimensions: approx. 220x120x10 mm³

U19560

Additionally required:
Overhead projector

U19560



Iron Filings

250 g of iron filings for displaying magnetic field lines. In a storage flask.

U11451

Additionally recommended:
U11452 Shaker

Shaker

Plastic flask with a fine hole for scattering iron filings evenly.

U11452

Hexagonal Magnet Model

Demonstration apparatus for the properties of the crystal lattice of ferromagnetic materials, particularly Weiss domains, Barkhausen jumps, saturation, hysteresis and Curie temperature. 117 freely moving magnetic needles are supported in a hexagonal arrangement between two connected transparent acrylic plates. For projection on the overhead projector.

Length of magnetic needles: approx. 17 mm
 Dimensions of plate: approx. 150x150 mm²

U15350

Additionally recommended:
Overhead projector
U8495185 Pair of Flat Coils

Magnet Model, Cubic

Like U15350, but with magnets in a square arrangement.

U15351

Additionally recommended:
Overhead projector
U8495185 Pair of Flat Coils

Pair of Flat Coils

Pair of coils for generating a near-uniform magnetic field for the hexagonal and cubic magnet models (U15350 and U15351). This makes it possible to observe changes in the magnetic flux when the magnetisation is changed.

Number of turns: 125
 Resistance: 7 Ω approx.
 Permitted current: 1 A
 Dimensions: 150x30x18 mm³ approx.
 Weight: 85 g approx.

U8495185

Additionally recommended:
U33020-230 DC-Power-Supply 0 – 20 V, 0 – 5 A (230 V, 50/60 Hz)
 or
U33020-115 DC-Power-Supply 0 – 20 V, 0 – 5 A (115 V, 50/60 Hz)



U15351

U15350



U8495185

Experiment Topics:

- Magnetic flux lines of bar and horseshoe magnets
- Magnetic screening
- Magnetic induction
- To display the shapes adopted by magnetic field lines around a straight conductor, a conductor loop, a cylindrical coil, and an electromagnet

Set of Apparatus for Displaying Magnetic Fields

Equipment set for demonstration experiments designed to make visible the magnetic field distribution of permanent magnets and current carrying conductors. Also compatible for use with a daylight projector. The acrylic glass boxes containing iron filings are equipped with a pouring lip so that the used fillings can easily be refilled into the storage bottle.

Acrylic glass boxes: approx. 185x125x40 mm³
 Storage tray: approx. 430x380x25 mm³
 Weight: approx. 1.5 kg

Contents:

- 1 Straight conductor mounted on box made of transparent acrylic
- 1 Ring-shaped conductor mounted on box made of transparent acrylic
- 1 Cylindrical coil mounted on box made of transparent acrylic
- 1 Magnetic overlay with guide studs on acrylic box
- 1 Acrylic plastic box with smooth surface for scattering materials
- 2 Soft iron bars
- 1 Flat soft iron bar
- 2 Permanent flat bar magnets
- 1 Soft iron ring
- 1 Magnetic needle with holder
- 1 Scattering bottle with iron filings
- 1 Pre-molded storage tray

U8491790

Additionally required:

U117361 DC-Power Supply, 0 – 16 V, 0 – 20 A
 (115 – 230 V, 50/60 Hz)

Additionally recommended:

Overhead Projector

Current Conductor on Acrylic Base

Current Conductor for demonstrating the magnetic fields of current-carrying conductors. The magnetic field can be made visible with iron powder. Acrylic glass base with two 4 mm safety sockets. For projection on the overhead projector.

Dimensions of acrylic glass base: approx. 185x150x30 mm³

Straight Conductor on Acrylic Base

U8491791

Loop-Shaped Conductor on Acrylic Base

U8491792

Coil on Acrylic Base

Number of turns: 7
 Coil diameter: approx. 35 mm
 Coil length: approx. 65 mm

U8491793

Additionally required:

U117361 DC-Power Supply, 0 – 16 V, 0 – 20 A
 (115 – 230 V, 50/60 Hz)

U11451 Iron Filings

U11452 Shaker



U8491790

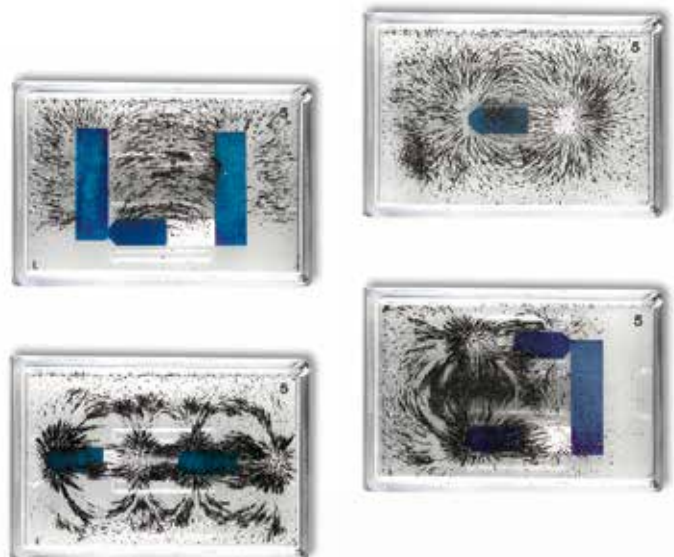

U8491792

U8491793

U8491791

Pair of Helmholtz Coils on Mounting Plate

Pair of coils with variable separation for determining the optimum Helmholtz configuration and for quantitative testing of the uniformity of the magnetic field. The apparatus comprises a pair of coils arranged parallel to each other, mounted on a robust metal base plate with a holder for a magnetic field meter to measure the magnetic field. One coil and its holder are moveable. There are two scales printed on the base plate to allow coil separation to be read off and to determine how far the measurement probe's position deviates laterally from the coil axis respectively.

- Average coil diameter: 125 mm
- Number of turns: 100 each
- Max. coil separation: 240 mm
- Max. permissible current: 5 A
- Terminals: 4 mm safety sockets
- Base plate: approx. 400x200 mm²

U21901

Additionally recommended:
U11360 Magnetic Field Sensor

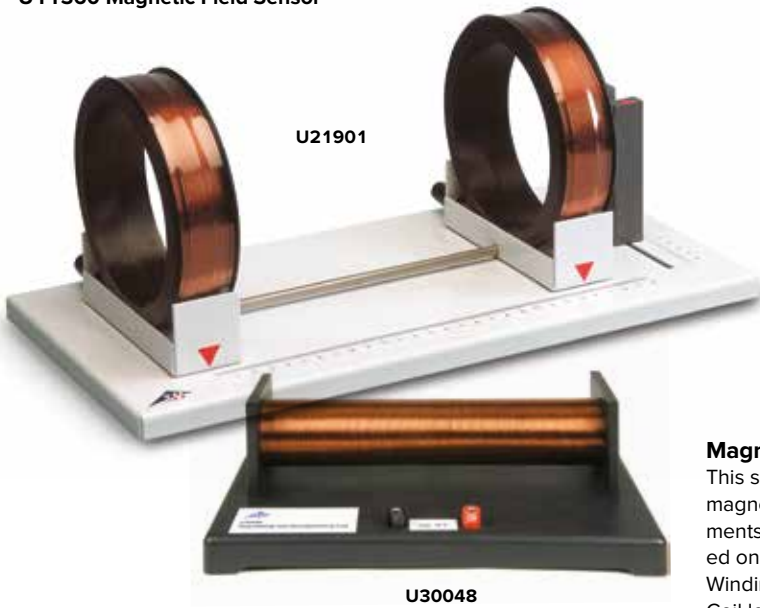

Coil with Variable Number of Turns per Unit Length

Cylindrical coil of variable length for investigating the magnetic field strength as a function of the closeness of the turns.

- Coil diameter: 100 mm
- Number of turns: 30
- Coil length: 490 mm
- Max. Current: 10 A, for short periods 20 A
- Terminal: 4 mm safety sockets

U8496175

Additionally recommended:
U8496150 Stand for Cylindrical Coils
U11360 Magnetic Field Sensor



Field Coils

Cylindrical coils for experiments investigating magnetic field intensity as a function of the current and the number of turns, for demonstrating that the field intensity is independent of the coil cross section.

- Coil bobbins made of acrylic.
- Number of turns: 120
- Coil length: 490 mm
- Max. current: 10 A, for short periods 20 A
- Terminal: 4 mm safety sockets

Field Coil 100 mm diam.

U12252

Field Coil 120 mm diam.

U12253

Additionally recommended:
U8496150 Stand for Cylindrical Coils
U11360 Magnetic Field Sensor

Magnetising Coil

This solenoid allows you to magnetise and demagnetise ordinary magnets or iron bars in addition to conducting inductance experiments. The rugged unit consists of insulated copper winding, mounted on a base with 4mm sockets and a switch.

- Windings: 1000
- Coil length: 250 mm
- Coil radius: 35 mm internal
- Operating Voltage: max. 12 V DC or 12 V AC
- Dimensions: 305x200x100 mm³
- Mass: 2 kg

U30048

Stand for Cylindrical Coils

- Made of acrylic.
- Dimensions: approx. 165x120x75 mm³
- Weight: approx. 185 g

U8496150

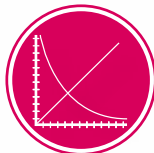

UE3030500
 PDF online

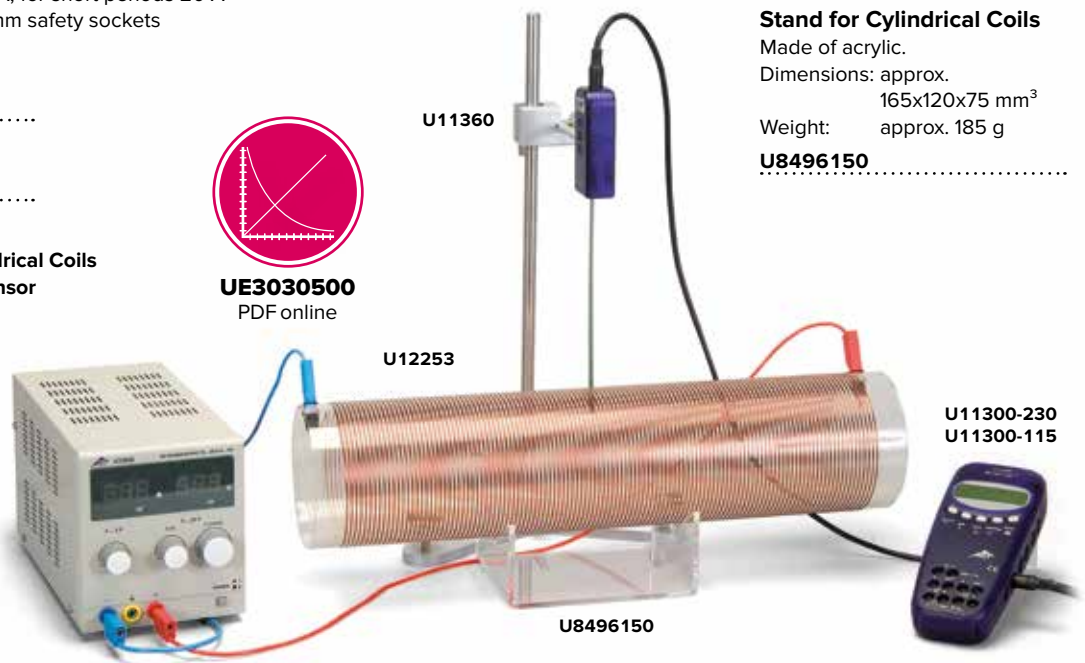

Measurement of the magnetic field around a current carrying coil

Determining the Helmholtz Configuration: Measurement of Magnetic Field for a Pair of Coils with Variable Separation

Description	Art. No.
Pair of Helmholtz Coils on Mounting Plate	U21901
Teslameter 200 mT (230 V, 50/60 Hz)	U33110-230
or	
Teslameter 200 mT (115 V, 50/60 Hz)	U33110-115
DC Power Supply 0 – 20 V, 0 – 5 A (230 V, 50/60 Hz)	U33020-230
or	
DC Power Supply 0 – 20 V, 0 – 5 A (115 V, 50/60 Hz)	U33020-115
Digital Multimeter P3340	U118091
Pair of Safety Experiment Leads, 75 cm	U13812



Measurement of Magnetic Field for a Pair of Coils with Variable Separation

Magnetic Fields

Set of Four Conductors for Biot-Savart Experiments

Equipment set comprising a straight conductor and three circular ones for experimental investigation of how magnetic flux density is calculated according to the Biot-Savart law.

Connectors: 4-mm plug

Maximum

continuous current: 20 A

Diameter of

circular conductors: 120 mm, 80 mm and 40 mm

Length of

straight conductor: 400 mm

U8557240

Additionally recommended:

U8557220 Holder for Plug-in Components

U8557470 Holder for Magnetic Field Sensor

U8533999 Flexible Magnetic Field Sensor

or

U8533997 Magnetic Field Sensor, Axial/Tangential

U8533982 Teslameter E

U17151 Optical Bench U, 600 mm

U17160 Optical Rider U, 75 mm (2x)

U117361 DC Power Supply 0 – 16 V, 0 – 20 A

U13812 Pair of Safety Experiment Leads, 75 cm

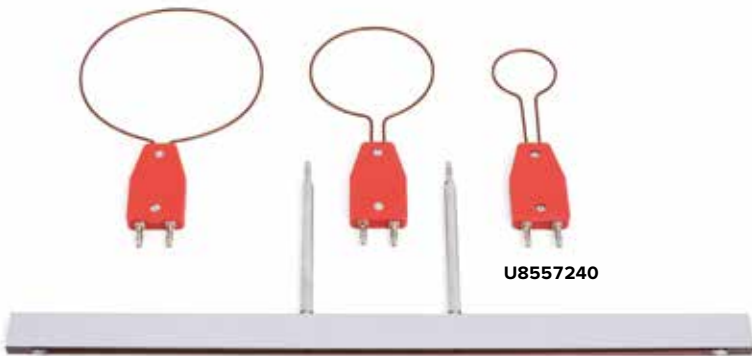

Holder for Magnetic Field Sensor (not shown)

Holder on a stem to accommodate magnetic field sensor in experiments to confirm the Biot-Savart law.

U8557470

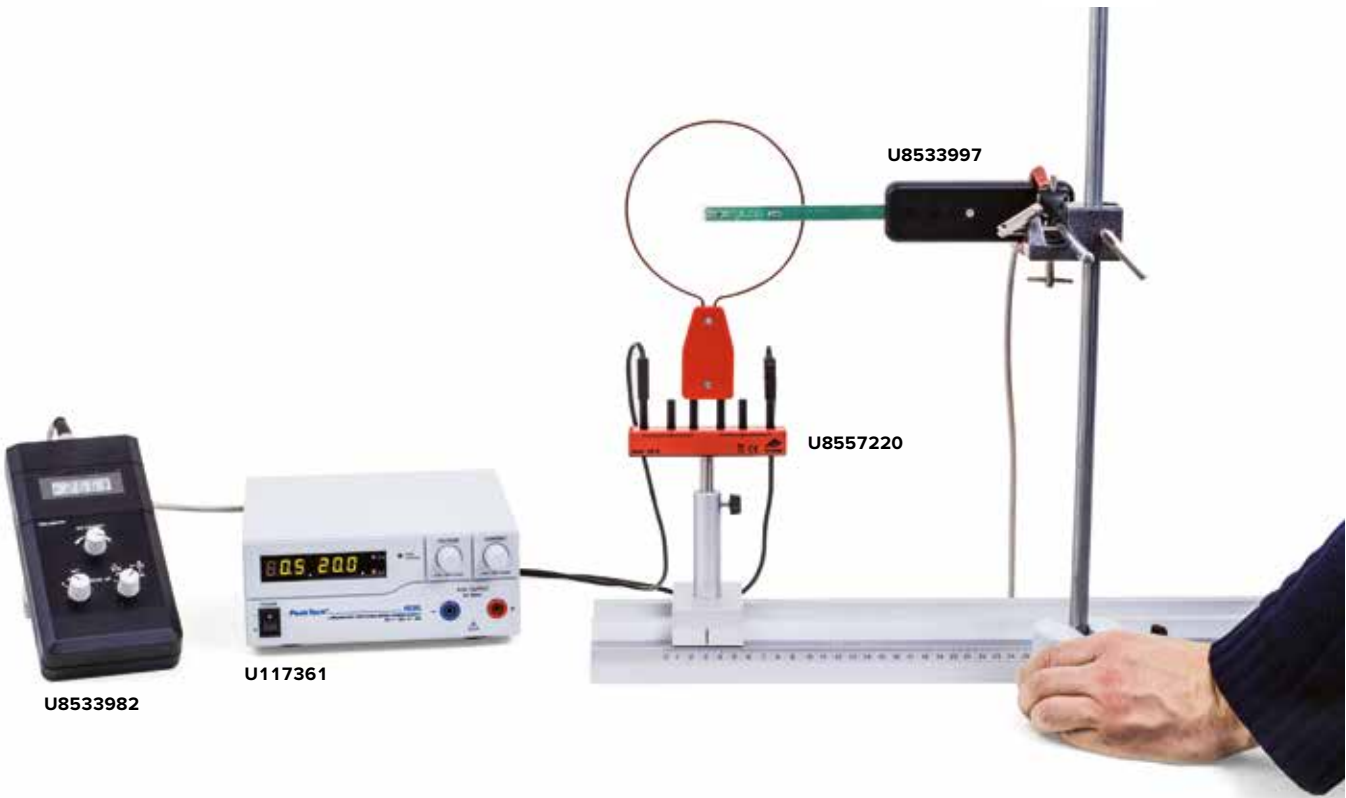

Electricity and Magnetism

Current Balance Equipment Set

Equipment set for measuring force on a current-carrying conductor in a magnetic field as a function of the current, of the magnetic field or of the length of the conductor. The force is composed of the apparent change in the weight of the holder for the permanent magnets, which is measured by means of a sensitive set of scales.

Max. current: 5 A
 Weight: 500 g approx.

Contents:

- Conductor, 1 cm
- Conductor, 2 cm
- Conductor, 4 cm
- Conductor, 8 cm
- Holder for permanent magnets
- 6 Permanent magnets
- Folding power feed and holder for conductors

U17209

Additionally required:

- U15001 Steel Rod 25 cm**
- U13270 Tripod Stand, 150 mm**
- U13813 Pair of Experiment Leads**
- U42048-230 Electronic Scale 200 g, 0,01 g (230 V, 50/60 Hz)**
- U33020-230 DC Power Supply 0 – 20 V, 0 – 5A (230 V, 50/60 Hz)**
or
- U33020-115 DC Power Supply 0 – 20 V, 0 – 5A (115 V, 50/60 Hz)**



U42048-230

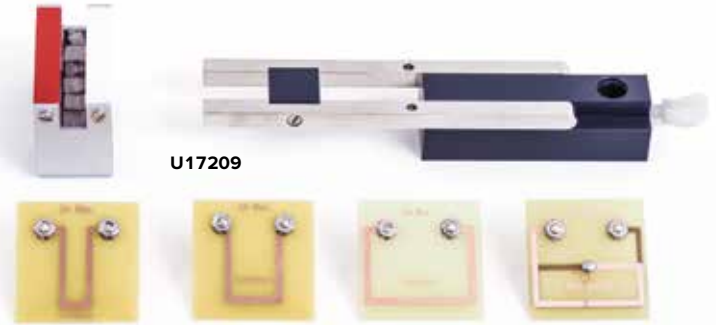

U17209



U33020-230
U33020-115



U30065

Lorentz Force Apparatus

The apparatus consists of a powerful U shaped magnet, a pair of brass rails complete with 4mm sockets and a brass axle. A power supply unit is connected to the rails. When the axle is placed on the rails the electric circuit is completed and the axle is repelled along the rails in a direction either towards or away from the magnetic field. Reversing the current will have the opposite effect.

Dimensions: 175x65x70 mm³

U30065

Additionally required:

- U33020-230 DC Power Supply 0 – 20 V, 0 – 5 A (230 V, 50/60 Hz)**
- or
- U33020-115 DC Power Supply 0 – 20 V, 0 – 5 A (115 V, 50/60 Hz)**

Experiment Topics

- Diamagnetism and paramagnetism
- Waltenhofen's pendulum
- Force on a conductor in a magnetic field in parallel and transverse configurations
- Measuring currents with a current balance

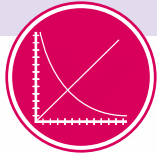

UE3030300
PDF online



Equipment Set Electromagnetism

This equipment consists of a stable, firm, anodised-aluminium tripod with pre-defined magnet positions and accessory mountings. The deflection of the conductor swing can be adjusted in steps of 0, 15, 30 and 45 mm for current balance experiments.

Contents:

- 1 Aluminium tripod, anodised
- 1 Conductor swing with 4 mm safety jacks
- 2 Waltenhofen pendulums (solid and slotted)
- 1 Glass rod and polyester thread with hook

- 1 Aluminium rod and polyester thread with hook
- 1 Knurled screw

U10371

Additionally required:

- U10370 Permanent Magnet with Adjustable Pole Spacing**
 - U33020-230 DC Power Supply 0 – 20 V, 0 – 5 A (230 V, 50/60 Hz)**
- or
- U33020-115 DC Power Supply 0 – 20 V, 0 – 5 A (115 V, 50/60 Hz)**

Lorentz Motor

Comprising a motor armature without an iron core, this device is intended for installation inside the permanent magnet with adjustable pole spacing (U10370). The coil is rotated purely by the Lorentz force, its direction of rotation depending on the direction of the current.

U10372

Additionally required:

- U10370 Permanent Magnet with Adjustable Pole Spacing**
 - U33020-230 DC Power Supply 0 – 20 V, 0 – 5 A (230 V, 50/60 Hz)**
- or
- U33020-115 DC Power Supply 0 – 20 V, 0 – 5 A (115 V, 50/60 Hz)**

Permanent Magnet with Adjustable Pole Spacing

This permanent magnet has an adjustable pole spacing and a high field strength arising from the use of two neodymium magnet elements. It comes with a black-finished iron yoke, knurled handles made of high-grade steel and attachable pole shoes. This magnet system can be installed horizontally or vertically.

- Magnet: 20x10 mm²
- Pole shoes: 20x50 mm²
- Pole spacing: 2 – 80 mm
- Field strength at centre of gap: 20 mT – 1000 mT

U10370

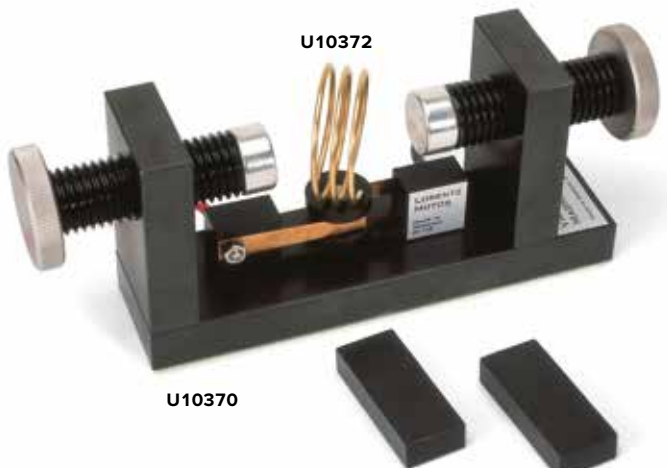

Electric Motor and Generator, Complete

Functioning model for demonstration of how a DC motor, as well as DC and AC generators, work. The model is equipped with a commutator, slip ring, pick-ups and armature coil and is mounted on a transparent acrylic plate with connection sockets, drive pulley and rubber drive belt. Includes horseshoe magnet, 70 mm.

Dimensions: approx. 130x150 mm²
 Weight: approx. 850 g

U8481531



Operating as an AC generator

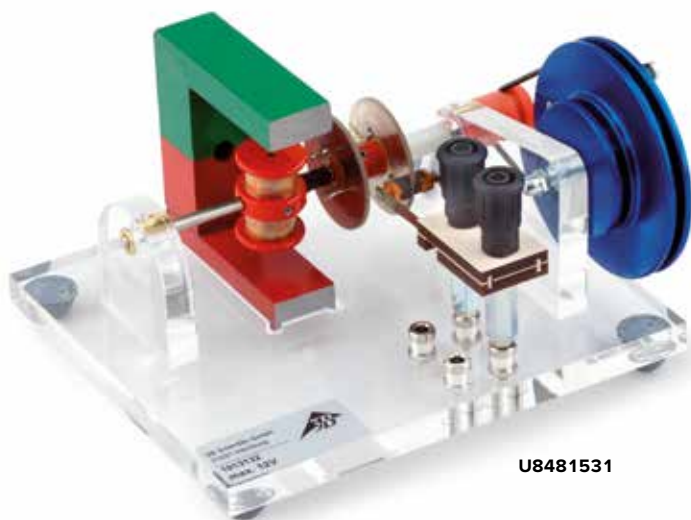

U8481531



Operating as a DC generator

Induction Apparatus

Apparatus for demonstrating the induced voltage in a frame coil that is moved through the magnetic field produced by a magnet plate of limited area or by the rotation of a current-carrying conductor in the magnetic field of the magnet plate. By varying the speed of motion of the frame coil, the direction of motion and the number of turns in the coil, the induction law can be derived experimentally and quantitatively. The transparent design of the magnetic plate and coils means that they can be demonstrated on the overhead projector. An unfoldable support permits inclined set-up.

Operating voltage: 2–12 V DC
 Frame coil: approx. 185x125 mm²
 Total dimensions: approx. 585x200x55 mm³
 Weight: approx. 3 kg

Contents:

- 1 Induction apparatus with retractable magnetic plate
- 1 Frame coil
- 1 Rolling conductor loop

U8496270

Additionally required:

U33020-230 DC-Power Supply Unit 0 – 20 V, 0 – 5 A (230 V, 50/60 Hz)

or

U33020-115 DC-Power Supply Unit 0 – 20 V, 0 – 5 A (115 V, 50/60 Hz)

U17450 Analogue Multimeter AM50

Additionally recommended:
Overhead Projector



UE3040200
 PDF online

U33020-230
U33020-115

U17450

U8496270

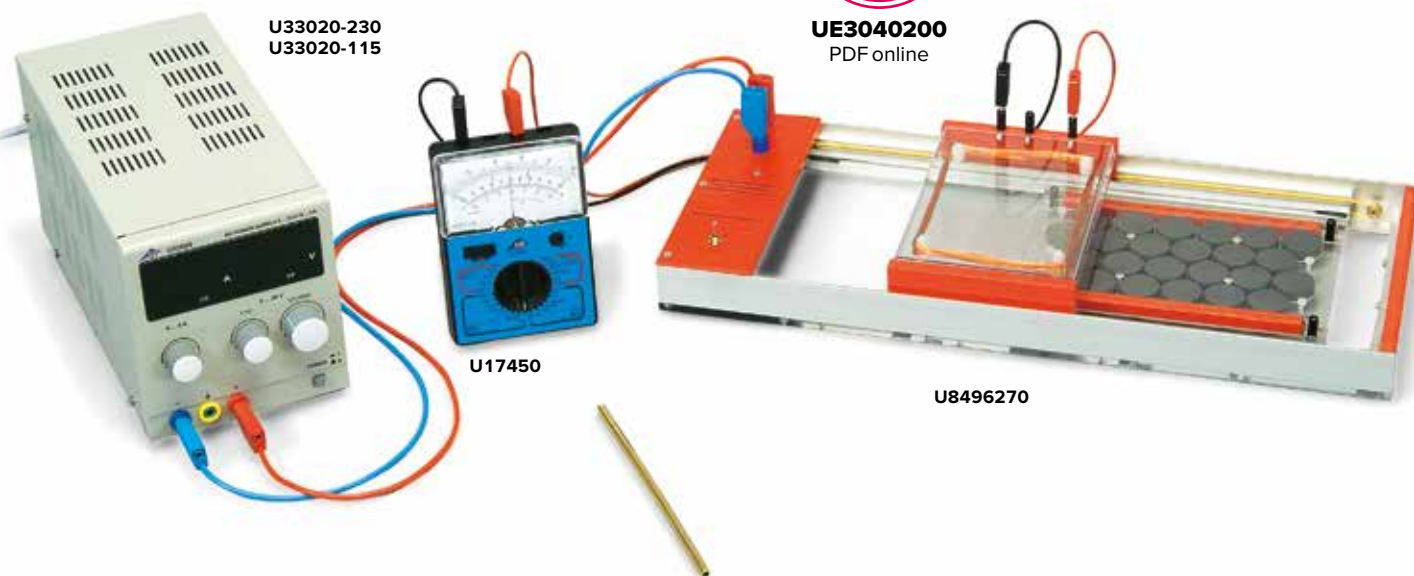

Flat Coil in a Rotatable Frame

Flat coil in a plexiglas frame, mounted so that it can be rotated, for use in combination with 300 mm Helmholtz coils (U8481500). When the flat coil is rotated in the magnetic field of the Helmholtz coils, an alternating voltage is induced. The electrical connection to the coil is established via sliding contacts. A hand crank and pulley on the rotary frame's axle are used to drive the coil.

Number of turns: 4000
 Effective area: 42 cm²
 Dimensions: approx. 110x80x11 mm³
 Weight: approx. 360 g

U8496320

Additionally required:

- U8481500 Helmholtz Coils, 300 mm**
 - U17450 Analogue Multimeter AM50**
 - U33020-230 DC-Power Supply Unit 0 – 20 V, 0 – 5 A (230 V, 50/60 Hz)**
- or
- U33020-115 DC-Power Supply Unit 0 – 20 V, 0 – 5 A (115 V, 50/60 Hz)**



Helmholtz Coils 300 mm

Pair of coils with large diameter in Helmholtz configuration used to produce a homogeneous magnetic field. The coils can be switched in parallel or in series. A spring clip on the top crossbar is used to mount the Hall sensor during measurements of the magnetic field.

Coil diameter: approx. 300 mm
 Number of turns per coil: 124 each
 DC resistance: 1.2 Ω each
 Maximum coil current: 5 A each
 Terminals: 4 mm safety sockets
 Weight: 4.1 kg approx.
 Max. field: 3.8 mT

U8481500

Additionally recommended:

- U11360 Magnetic Field Sensor**



Tube with Six Induction Coils

Plastic tube with six identical induction coils connected in series. When the bar magnet provided is allowed to fall through the tube, a voltage is induced in each of the coils in turn. As the velocity of the magnet increases with time during its fall, the amplitudes of the voltage peaks also increase, and their width decreases. The area under each voltage peak remains constant.

Coil width: 10 mm
 Distance between coils: 190 mm
 Dimensions: approx. 1500 mm x 20 mm diam.
 Weight: approx. 500 g

U8511200

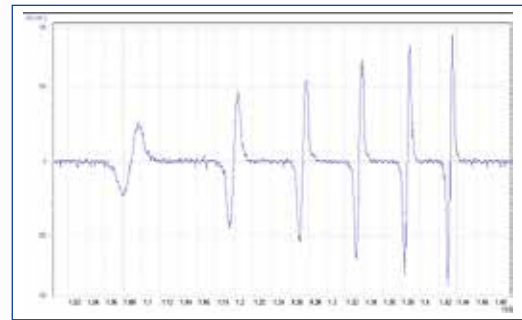

The induced voltage as a function of time

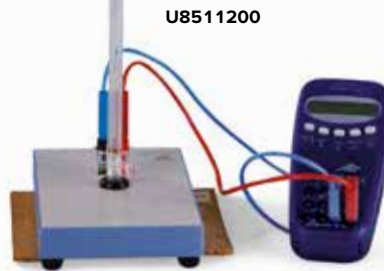

U8511200

- U11300-230**
- U11300-115**

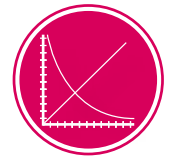

UE3040100
 PDF online

Demonstration Dynamo

This model dynamo demonstrates the conversion of mechanical energy into electrical energy. All working parts of the electric motor are clearly visible. The motor is mounted on a base plate and coupled by a rubber belt to a hand-drive pulley. External connection is via 4 mm sockets with a light emitting diode acting as an output indicator. The magnetic field is provided by a permanent magnet.

Base plate: 200x100x20 mm³
 Hand-drive pulley: 150 mm diam.
 Height: 180 mm

Contents:

- 1 Apparatus on base plate
- 1 Removable magnet
- 1 Stackable light emitting diode
- 1 Small dynamo pulley

U30066



U30066



UE3040400
PDF online



Waltenhofen's Pendulum

Equipment set for the demonstration of the effects of eddy currents and braking. A pendulum object composed of a solid steel plate swings back and forth between the poles of an electromagnet with the power switched off. When the magnet is switched on, the pendulum motion of the object comes to an almost immediate halt. If the plate contains slots more time elapses before the plate stops moving, i.e. the braking effect is severely reduced. The equipment set consists of a pendulum rod and four aluminium pendulum plates with various shapes: rectangle, rectangle with slits, circular disk, ring and ring with slits.

Rectangular: approx. 100x60 mm²
Ring: approx. 30 mm diam. (interior),
approx. 60 mm diam. (exterior)

U8497500.....

Additionally required:

- U8497180 Transformer Core D**
- U8497200 Pair of Pole Pieces**
- U8497440 Coil with 1200 Turns (2x)**
- U33020-230 DC-Power Supply 0 – 20 V, 0 – 5 A (230 V, 50/60 Hz)**
- or
- U33020-115 DC-Power Supply 0 – 20 V, 0 – 5 A (115 V, 50/60 Hz)**



Set of 3 Induction Coils

Coils for experiments on induction in combination with the 120 mm diameter field coil (U12253) and for experiments on resonant electric circuits. The coils are only designed for safety extra low voltage (SELV). The spools are made of transparent acrylic plastic.

Connection: 4 mm safety sockets
Coil length: 170 mm

Coil 1

Number of turns: 300 with taps at 100 and 200 turns
Coil cross section: 50x50 mm²

Coil 2

Number of turns: 300
Coil cross section: 50x30 mm²

Coil 3

Number of turns: 300
Coil cross section: 50x20 mm²

U122501.....

Additionally recommended:
U12253 Field Coil 120 mm diam.



Variable Inductance Coil

Coils for measuring inductance and self-inductance of a current-carrying coil depending on the insertion of an iron core and for investigating AC circuits. Coil of copper wire in a shock-resistant plastic casing with lifting handles. A coated iron core is mounted on a worm screw for moving in and out of the coil. With printed scale in cm for reading the length of core inserted into the coil.

Number of windings: 3000
Max. permissible voltage: 30 V AC, 60 V DC
Max. permissible current: 2 A
Inductance at 1 A: approx. 0.15 – 1.4 H, continuously adjustable
Resistance: 12.5 Ω
Terminals: 4 mm safety plugs
Dimensions: approx. 265x145x130 mm³
Weight: approx. 6.2 kg

U21903.....



Lenz's Law Copper Tube

Handy demonstration apparatus for illustrating Lenz's law and induction of eddy currents. A small steel cylinder and a magnet of the same dimensions fall at different speeds through a copper tube because the motion of the magnet causes eddy currents to be induced, resulting in a magnetic field which slows the fall of the magnet. Includes 2 plastic caps so that the tube can be used as a container.

Length: 320 mm approx.
Diameter: 15 mm approx.

U30086



U30086

Lenz's Law Apparatus

Instrument for demonstrating Lenz's Law qualitatively by bringing a magnet close to it. One closed and one open conductor loop, with point bearing on base.

Length: approx. 195 mm
Height: approx. 110 mm

U8556012

Additionally required:

U20550 Cylindrical Bar Magnet 200x10



U8556012

Bicycle Dynamo, Transparent

Bicycle dynamo in transparent housing. It is possible to observe the movement of the generator components while the dynamo is in operation.

Generated voltage: 6 V approx.
Generated power: 3 W
Dimensions: 95x34x25 mm³ approx.

U29538



U29538

Experiment Motor with Gearbox

Experiment motor for universal use in experiments on rotational motion, e.g. for experiments using Watt's governor (U8403115). Can also be used as a generator in conjunction with the included hand crank. Robust clockwise and counter-clockwise rotating IDC motor with epicyclic gearbox and quick-action chuck in a tough anodized aluminum casing with removable and adjustable stainless steel stand rod. Can also be mounted on the clamp for the projectile launcher (U10361). Speed of rotation is adjusted by altering the supply voltage. Adjustable torque. Includes 3 belt pulleys of different diameters on a mounting axle.

Speed without load: approx. 480 rpm at 12 V
Speed sensitivity: approx. 40 rpm per V
Span of chuck: 0.8 to 10 mm
Stand rod: 12 mm diam.
Pulleys: 10 mm diam., 20 mm diam., 40 mm diam.
Axle: 10 mm diam.
Drive belt: 130 mm diam. x 4 mm
Nominal voltage: 12 V DC, 5A
Connection: via 4-mm safety sockets
Dimensions: 210x95x60 mm³
Mass: 1.2 kg

Contents:

Experiment motor
Stand rod with knurled screws
Hand crank
Pulleys
Drive belt

U10375



U10375



Additionally required:

U33020-230 DC Power Supply 0 – 20 V, 5 A (230 V, 50/60 Hz)
or
U33020-115 DC Power Supply 0 – 20 V, 5 A (115 V, 50/60 Hz)

Additionally recommended:

U40160-230 Digital Stroboscope (230 V, 50/60 Hz)
or
U40160-115 Digital Stroboscope (115 V, 50/60 Hz)

Also suitable for induction experiments

Experiment topics:

- Voltage transformation
- Transformer under load
- Current transformation
- Autotransformer
- Leakage field experiments
- Induction oven
- Point welding
- Fusing experiments
- High voltage experiments



UE3040500
PDF online

U8497460

U8497450

U8497440

U8497430

Primary or Secondary Coils for Transformer Core D

Coils, covered with impact resistant plastic so that they are safe to touch, for use as primary or secondary coils in combination with transformer core D (U8497180). With safety connection sockets. As secondary coils these can output either low or high voltage, depending on the primary voltage, and therefore they cannot be used in student experiments.

	U8497430	U8497440	U8497450
Number of turns	600	1200	6000
Taps	200/600	400/1200	2000/6000
Resistance	3 Ω	12 Ω	300 Ω
Max. current	2.2 A	1.2 A	0.2 A
Inductance	15 mH	60 mH	1,5 H

Low Voltage Coil D

Secondary coil for use with a transformer core D (U8497180) to generate low voltages up to 24 V. With five tapping points. Covered by impact resistant plastic, safe to touch.

Terminals:	Safety sockets
Number of turns:	72
Taps:	6/ 30/ 54/ 66/ 72
Resistance:	0.1 Ω
Max. current:	12 A
Inductance:	0.23 mH

U8497410

Additionally required:

U8497180 Transformer Core D

U8497420-230 Mains Coil D with Connecting Lead (230 V, 50/60 Hz)

or

U8497420-115 Mains Coil D with Connecting Lead (115 V, 50/60 Hz)

Mains Coil D with Connecting Lead

Coil that is safe to touch with mains connecting lead for use as primary coil in combination with the transformer core D (U8497180). Covered by impact resistant plastic, safe to touch.



U8497180,
U8497420-230/U8497420-115,
U8497410

Transformer Core D

U shaped core made of high grade laminated transformer plates, with removable yoke. Provided with two clips for securing the yoke or attaching special pole shoes with drilled holes (U8497200).

Cross-section of core: 40x40 mm²

U-core: approx. 150x130 mm²

Length of yoke: approx. 150 mm

Weight: approx. 6 kg

U8497180**High Voltage Coil D including 2 Horn Shaped Electrodes**

Secondary coil for transformer core D (U8497180), generating high voltages which can cause spark discharges between two shielded horn electrodes. Covered with impact resistant plastic, safe to touch.

Number of turns: 24000

Open-circuit voltage: approx. 9200 V

Resistance: 10 kΩ

Max. current: 0.02 A

Inductance: 28 H

U8497460

Additionally required:

U8497180 Transformer Core D

U8497420-230 Mains Coil D with Connecting Lead (230 V, 50/60 Hz)

or

U8497420-115 Mains Coil D with Connecting Lead (115 V, 50/60 Hz)

High Current Coil D for Nail Fusing Experiment

Secondary coil for use with the transformer core D (U8497180) to generate a large current sufficient to melt nails. Covered by impact resistant plastic.

Number of turns: 6

Resistance: 3 mΩ

Max. current: 60 A

Inductance: 0.25 mH

U8497406

U8497420-230

U8497420-115

U8497410

U8497406

	U8497420-230	U8497420-115
Description	Mains Coil D with Connecting Lead (230 V, 50/60 Hz)	Mains Coil D with Connecting Lead (115 V, 50/60 Hz)
Number of turns	600	300
Resistance	3 Ω	0.75 Ω
Max. current	2.2 A	4.4 A
Inductance	15 mH	7.5 mH



U8497390

Coil D, 900 Turns

Coil with 900 turns and thermal overload protection. For generating powerful magnetic fields in conjunction with the U-core (U8497215).

Number of turns: 900
 Inductance: approx. 34 mH
 Resistance: approx. 4.8 Ω (at room temperature)
 approx. 6.0 Ω (at maximum amperage)

Maximum permissible amperage: 5 A (for approx. 7 minutes)
 Waiting time for reactivation after thermal overload: approx. 10 minutes
 Weight: approx. 1.6 kg

U8497390



U8497331

U8497470

Metal Ring

Metal ring for performing Thomson's ring experiment in conjunction with the mains coil (U8497420-230 resp. U8497420-115) and the transformer core D (U8497180). First the metal ring is fitted around one stem of a U core and allowed to rest on the mains coil. The stem of the U core is extended to the yoke positioned vertically on top of it. When the mains coil is switched on the ring jumps into the air.

Diameter: 55 mm

U8497470

Additionally required:

U8497180 Transformer Core D

U8497420-230 Mains Coil with Connecting Lead (230 V, 50/60 Hz)

or

U8497420-115 Mains Coil with Connecting Lead (115 V, 50/60 Hz)

High Current Coil with Five Turns

Secondary coil for transformer core D (U8497180), generating high voltages which can be used for spot-welding of metal sheets up to 2 mm thick.

Number of turns: 5
 Short-circuit current: approx. 260 A
 Coil diameter: 57 mm
 Weight: approx. 650 g

U8497320

Additionally required:

U8497330 Set of Metal Strips

U8497180 Transformer Core D

U8497420-230 Mains Coil with Connecting Lead (230 V, 50/60 Hz)

or

U8497420-115 Mains Coil with Connecting Lead (115 V, 50/60 Hz)



U8497320

Set of Metal Strips

Five metal strips used to demonstrate spot welding techniques in conjunction with a coil with 5 turns (U8497320).

Dimensions: 120x10 mm²

U8497330



U8497330

Set of 20 Nails for Nail Fusing Experiment

20 nails for experiments involving fusing using high current coil (U8497406).

U8497331



U8497310

Fusion Ring

Circular aluminium channel with insulated handle for demonstrating the principle of induction melting, when used as a secondary coil with the transformer core D (U8497180).

Max. current: approx. 1300 A
 Internal diameter: approx. 57 mm
 Weight: approx. 80 g

Suitable melting materials:

Wood's Alloy, Tin

U8497310

Additionally required:

U8497180 Transformer Core D

U8497420-230 Mains Coil with Connecting Lead (230 V, 50/60 Hz)

or

U8497420-115 Mains Coil with Connecting Lead (115 V, 50/60 Hz)



U8497220



U8497215

Pair of Clamps D

Pair of clamps from the transformer core D (U8497180).

U8497181



U8497200



U8497181



U8497205

Pair of Pole Shoes D

Pair of pole shoes with conical ends for generating a highly non-uniform magnetic field when fitted onto the U core D (U8497215). Provided with holes for optical experiments in a magnetic field.

Pole shoe: approx. 40x40 mm²
Weight: approx. 1.7 kg

U8497200

Pole Shoe Fitting D

Pole shoe fitting with adjustable separation for generating a uniform magnetic field on a U-shaped core D (U8497215). Includes two 20-mm spacers, four 10 mm spacers and four 5 mm spacers.

Dimensions: 150x120x40 mm
Weight: 5.7 kg

U8497220

U Core D

U shaped transformer core D (U8497180).

U8497215

Pair of Pole Shoes and Clamping Brackets D for Hall Effect

Pair of pole pieces for experiments on the semiconductor Hall effect. Including clamping brackets for mounting on the U-core D (U8497215).

Pole shoe dimensions: 40x40x75 mm³
Total weight: approx. 2 kg

U8497205

Experiment topics:

- Voltage transformation
- Transformer under load
- Current transformation
- Autotransformer
- Leakage field experiments
- Fusing experiments



U8498112

Transformer Core S

U-core with removable yoke made of high quality transformer laminate.

Core cross section: 20x20 mm approx.
U-core: 70x70 mm approx.
Length of yoke: 70 mm approx.

U8498112

U8498090, U8498070

High Current Coil S

Secondary coil for transformer core S (U8498112) for generating high current output.

No. of windings: 22
Max. Current: 10 A

U8498065



U8498070-U8498090



U8498065

**Transformer Coils S**

Impact resistant plastic covered coils, safe to touch, for assembling a transformer in conjunction with the transformer core S (U8498112).

Maximum voltage: 50 V (safety extra-low voltage)

Terminals: 4 mm safety sockets

Opening for iron

cores: approx. 20x20 mm²

Art. No.	Number of turns	Max. current	Inductance
U8498070	600	800 mA	approx. 6 mH
U8498080	800	600 mA	approx. 10 mH
U8498085	1200	400 mA	approx. 25 mH
U8498090	2400	200 mA	approx. 100 mH

Experiment Topics:

- Hertzian waves (high frequency electromagnetic waves)
- Absorption and transmission
- Corona discharge
- Spark discharge
- Wireless transmission of energy to a fluorescent lamp
- Standing waves on a Tesla coil

Tesla Transformer

Classic Tesla transformer for the generation of a safe high frequency high voltage starting from approx. 100 kV. The well-conceived, open configuration of all components facilitating demonstration of both design and function. The apparatus is rendered shock proof on account of its extra low voltage operation.

No. of turns in the primary coil: 2 – 10
 No. of turns in the secondary coils: 1150
 Primary voltage: 20 V AC
 Secondary voltage: >100 kV
 Transformer: approx. 330x200x120 mm³
 Secondary coils: approx. 240 mm x 75 mm diam.
 Weight: approx. 3 kg

Contents:

- 1 Tesla transformer, basic apparatus
- 1 Hand coil
- 1 Secondary coil
- 1 Spherical electrode, short
- 1 Spherical electrode, long
- 1 Needle electrode with spray wheel
- 1 Fluorescent tube
- 1 Reflector

U8496250

Additionally required:

U33035-230 AC/DC Power Supply 0 – 30 V, 6 A (230 V, 50/60 Hz) or

U33035-115 AC/DC Power Supply 0 – 30 V, 6 A (115 V, 50/60 Hz)

Additionally recommended:

U8496255 Additional Coil for Tesla Transformer

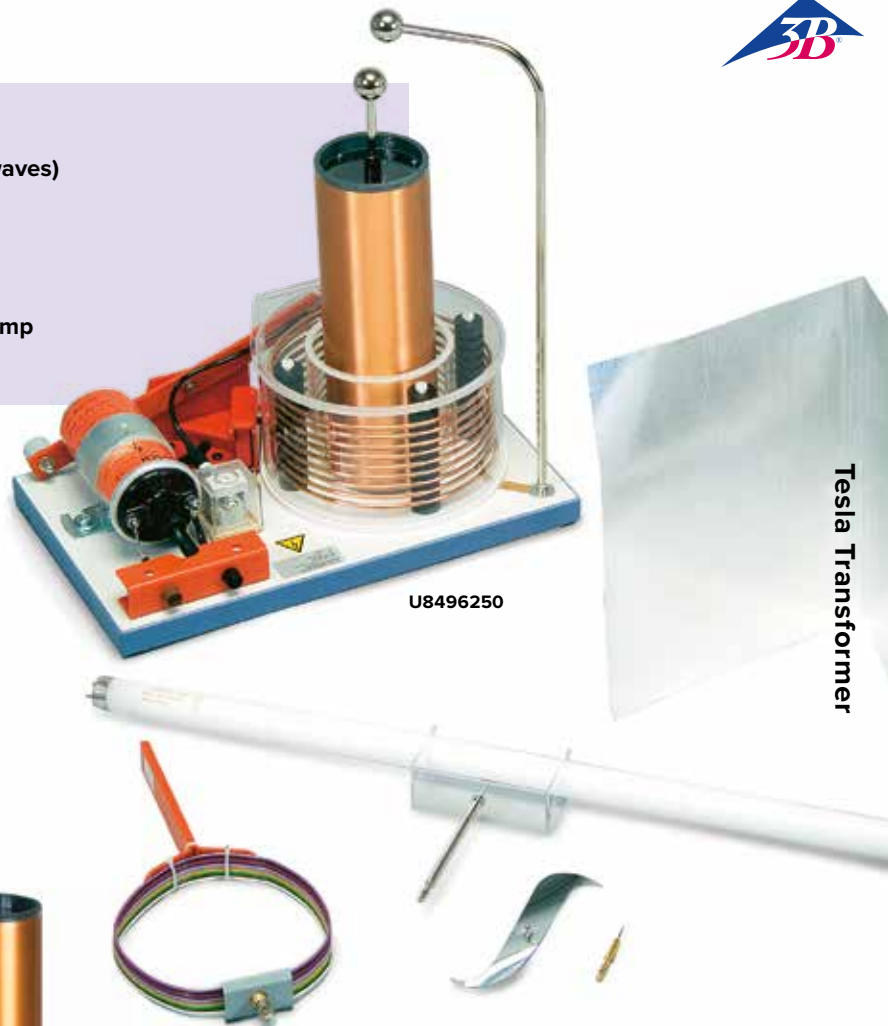

U8496250

Tesla Transformer

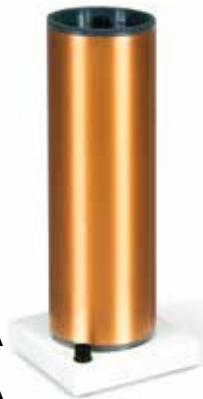

U8496255

Additional Coil for Tesla Transformer

Additional secondary coil for Tesla transformer (U8496250). Dimensions: approx. 240 mm x 75 mm diam.

U8496255



U33035-230
U33035-115

AC/DC Power Supply, 0 – 30 V, 0 – 6 A

Combined power supply with separate AC and DC outputs plus separate displays of output voltage and current. The DC output can be used as a voltage source or current source and can be set to any value within its range. The AC output features current limiting and is electronically protected against overload.

DC voltage: 0 – 30 V
 DC current: 0 – 6 A
 AC voltage: 0 – 30 V
 AC current: max. 6 A
 Dimensions: 380x140x300 mm³ approx.
 Weight: 12 kg approx.

AC/DC Power Supply, 0 – 30 V, 0 – 6 A (230 V, 50/60 Hz)

U33035-230

AC/DC Power Supply, 0 – 30 V, 0 – 6 A (115 V, 50/60 Hz)

U33035-115

Important Note:

Los aparatos used in training, teaching and research establishments which are designed for the investigation of electromagnetic phenomena is permitted to exceed the limits for interference emissions specified in the EMC directive. The interference generated by this apparatus is in excess of the permitted limits for interference emission according to the applicable EMC standards and could adversely affect the functionality of other electronic equipment in the building and its environment.

Users are responsible for the reduction and avoidance of such adverse effects and are expected to take the necessary precautions if any interference should occur which causes problems.

Experiment topics:

- Thermionic emission of electrons
- Linear propagation of electrons in field free spaces
- Deflection in magnetic and electric fields
- Determination of the polarity of electron charges
- Determination of specific charge e/m
- Inelastic electron collisions
- Luminescence
- Wave and particle nature of electrons

TELTRON® Electron Tubes D

Known throughout the world, tried and trusted over many years: Electron tubes with thermionic cathodes for experimental investigations of the properties of the free electron.

- Thermionic emission of electrons
- Linear propagation of electrons in field free spaces
- Deflection in magnetic and electric fields
- Determination of the polarity of electron charges
- Determination of specific charge e/m
- Inelastic electron collisions
- Luminescence
- Wave and particle nature of electrons

There is no need to take precautions against ionising radiation, since it is not necessary to use a high voltage of more than 5 kV to operate the tubes.

Electron Diffraction Tube D

Highly evacuated electron tube for demonstrating the wave nature of electrons through the observation of interference caused by passage of electrons through a polycrystalline graphite lattice (Debye-Scherrer diffraction) and rendered visible on a fluorescent screen. Also intended for determining the wavelength as a function of the anode voltage from the radii of the diffraction rings and the lattice plane spacing of graphite, as well as confirming de Broglie's hypothesis.

Filament voltage: 6.3 V AC
 Max. anode voltage: 5000 V
 Anode current: approx. 0.1 mA at 4000 V
 Focussing voltage: 0 – 50 V
 Lattice constant of graphite: $d_{10} = 0.213$ nm, $d_{11} = 0.123$ nm

U191711

Additionally required:

U191001 Tube Holder D

U138101 Set of Leads for Electron Tube Experiments

U33010-230 High Voltage Power Supply, 5 kV
(230 V, 50/60 Hz) or

U33010-115 High Voltage Power Supply, 5 kV
(115 V, 50/60 Hz)

Additionally recommended:

U8557000 Three-Pole Protective Adaptor

Note:

When using just one high-voltage power supply, the anode voltage and capacitor voltage cannot be selected independently of one another.

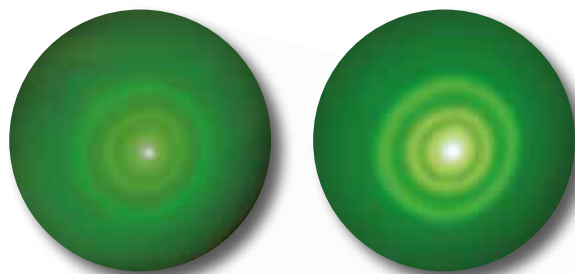

Recording in a darkened room with 3 kV and 4,5 kV.



U191711

Electron Deflection Tube D

Highly evacuated electron tube with focusing electron gun and fluorescent screen inclined relative to the beam axis, so that the path of the beam can be seen and the effects of electric and magnetic fields can be studied. The electron beam can be deflected electrically in the electric field of the built-in plate capacitor, and magnetically by using the Helmholtz pair of coils D (U191051). By adjusting the electric field so that it cancels the magnetic deflection, it is possible to determine the specific charge e/m and the velocity of the electrons.

Filament voltage: 6.3 V AC
 Max. anode voltage: 5000 V
 Anode current: approx. 0.1 mA at 4000 V
 Max. capacitor voltage: 5000 V
 Fluorescent screen: approx. 90x60 mm²
 Glass bulb: approx. 130 mm diam.
 Total length: approx. 260 mm

U19155

Additionally required:

U191001 Tube Holder D

U138101 Set of Leads for Electron Tube Experiments

U191051 Helmholtz Pair of Coils D

U33010-230 High Voltage Power Supply, 5 kV
(230 V, 50/60 Hz) (2x)

U33020-230 DC-Power Supply 0 – 20 V, 0 – 5 A
(230 V, 50/60 Hz) or

U33010-115 High Voltage Power Supply, 5 kV
(115 V, 50/60 Hz) (2x)

U33020-115 DC-Power Supply 0 – 20 V, 0 – 5 A
(115 V, 50/60 Hz)

Additionally recommended:

U8557001 Two-Pole Protective Adaptor



Follow us for news about physics!    



U19154

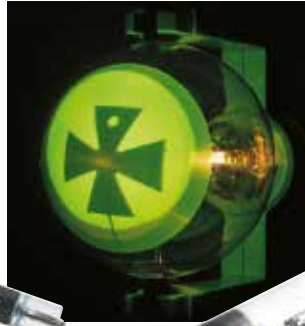

U19153

Perrin Tube D

Highly evacuated electron tube with focusing electron gun, fluorescent screen, and Faraday cage positioned on one side. For demonstrating the negative polarity of electrons and estimating the specific electron charge (charge-to-mass ratio) e/m by magnetic deflection into the Faraday cage, which is connected to an electroscope (U17250). It is also possible to investigate the deflection of electrons by two magnetic fields at right-angles to each other and to demonstrate the effects, for example by generating Lissajou figures.

- Filament voltage: 6.3 V AC
- Max. anode voltage: 5000 V
- Anode current: approx. 0.1 mA at 4000 V
- Beam current: 4 μ A at 4000V
- Glass bulb: approx. 130 mm diam.
- Luminescent screen: 85 mm diam.
- Total length: approx. 250 mm

U19154

Additionally required:

- U191001 Tube Holder D
- U138101 Set of Leads for Electron Tube Experiments
- U191051 Helmholtz Pair of Coils D
- U33010-230 High Voltage Power Supply, 5 kV (230 V, 50/60 Hz)
- U33020-230 DC-Power Supply 0 – 20 V, 0 – 5 A (230 V, 50/60 Hz) or
- U33010-115 High Voltage Power Supply, 5 kV (115 V, 50/60 Hz)
- U33020-115 DC-Power Supply 0 – 20 V, 0 – 5 A (115 V, 50/60 Hz)

Additionally recommended:

- U17250 Electroscope
- U19106 Auxiliary Coil
- U8557001 Two-Pole Protective Adaptor

Luminescence Tube D

Highly evacuated electron tube with divergent electron gun and three fluorescent strips in red, green and blue. For demonstrating stimulated light emission during and after electron bombardment.

- Filament voltage: 6.3 V AC
- Max. anode voltage: 5000 V
- Anode current: approx. 0.1 mA at 4000 V
- Glass bulb: approx. 130 mm diam.
- Total length: approx. 260 mm

U19152

Additionally required:

- U191001 Tube Holder D
- U138101 Set of Leads for Electron Tube Experiments
- U33010-230 High Voltage Power Supply, 5 kV (230 V, 50/60 Hz) or
- U33010-115 High Voltage Power Supply, 5 kV (115 V, 50/60 Hz)

Additionally recommended:

- U8557001 Two-Pole Protective Adaptor

Maltese-Cross Tube D

Highly evacuated electron tube with divergent electron gun, fluorescent screen and Maltese cross. For demonstrating the straight line propagation of electrons in the absence of any electric or magnetic field by projecting the shadow of a Maltese cross onto the fluorescent screen and for introducing students to electron optics.

- Filament voltage: 6.3 V AC
- Max. anode voltage: 5000 V
- Anode current: approx. 0.1 mA at 4000 V
- Glass bulb: approx. 130 mm diam.
- Luminescent screen: 85 mm diam.
- Total length: approx. 260 mm

U19153

Additionally required:

- U191001 Tube Holder D
- U138101 Set of Leads for Electron Tube Experiments
- U33010-230 High Voltage Power Supply, 5 kV (230 V, 50/60 Hz) or
- U33010-115 High Voltage Power Supply, 5 kV (115 V, 50/60 Hz)

Additionally recommended:

- U8557001 Two-Pole Protective Adaptor
- U191051 Helmholtz Pair of Coils D
- U33020-230 DC-Power Supply 0 – 20 V, 0 – 5 A (230 V, 50/60 Hz) or
- U33020-115 DC-Power Supply 0 – 20 V, 0 – 5 A (115 V, 50/60 Hz)



U19152

**Triode D**

Highly evacuated electron tube with thermionic cathode, control grid and anode for quantitative investigation of controllable high vacuum tubes, plotting the characteristics of a triode, demonstrating the negative polarity of the electron charge, studying the practical applications of a triode as an amplifier and generating undamped oscillations in LC circuits.

Max. heater voltage: 7.5 V AC/DC

Max. anode voltage: 500 V

Anode current: approx. 2 mA at 200 V anode voltage

Glass bulb: approx. 130 mm diam.

Total length: approx. 260 mm

U19151

Additionally required:

U191001 Tube Holder D

U138101 Set of Leads for Electron Tube Experiments

U17450 Analogue Multimeter AM50

U33000-230 DC Power Supply, 0 – 500 V (230 V, 50/60 Hz)

or

U33000-115 DC Power Supply, 0 – 500 V (115 V, 50/60 Hz)

Additionally recommended:

U8557001 Two-Pole Protective Adaptor

Gas Triode D

Electron tube filled with low pressure helium gas, with thermionic cathode, control grid, and anode for quantitative investigations of the typical properties of a gas-filled triode, recording the $I_A - U_A$ characteristics of a thyatron, observing independent and dependent discharges as well as discontinuous energy release of He atoms during inelastic collisions with free electrons.

Max. heater voltage: 7.5 V AC/DC

Max. anode voltage: 500 V

Anode current: approx. 10 mA at 200 V anode voltage

Glass bulb: approx. 130 mm diam.

Total length: approx. 260 mm

U19157

Additionally required:

U191001 Tube Holder D

U138101 Set of Leads for Electron Tube Experiments

U17450 Analogue Multimeter AM50

U33000-230 DC Power Supply, 0 – 500 V (230 V, 50/60 Hz)

or

U33000-115 DC Power Supply, 0 – 500 V (115 V, 50/60 Hz)

Additionally recommended:

U8557001 Two-Pole Protective Adaptor

Diode D

Highly evacuated electron tube with thermionic cathode and anode for investigating the thermoelectric effect (Edison effect) and measuring the emission current as a function of the heating power applied to the cathode. Also for plotting diode characteristics and for demonstrating the rectifying effect of a diode.

Max. heater voltage: 7.5 V AC/DC

Max. anode voltage: 500 V

Anode current: approx. 2 mA at 200 V Anode voltage

Glass bulb: approx. 130 mm diam.

Total length: approx. 260 mm

U191501

Additionally required:

U191001 Tube Holder D

U138101 Set of Leads for Electron Tube Experiments

U17450 Analogue Multimeter AM50

U33000-230 DC Power Supply, 0 – 500 V (230 V, 50/60 Hz)

or

U33000-115 DC Power Supply, 0 – 500 V (115 V, 50/60 Hz)

Additionally recommended:

U8557001 Two-Pole Protective Adaptor



		U191501	U19151	U19157
		Diode D	Triode D	Gas Triode D
U191001	Tube Holder D	required	required	required
U138101	Set of Leads for Electron Tube Experiments	required	required	required
U33000-230 or U33000-115	Power Supply, 500 V DC	required	required	required
U33010-230 or U33010-115	High Voltage Power Supply, 5 kV	–	–	–
U191051	Helmholtz Pair of Coils D	–	–	–
U33020-230 or U33020-115	DC-Power Supply 20 V	–	–	–
U17450	Analogue Multimeter AM50	required	required	required
U8557001	Two-Pole Protective Adaptor	recommended	recommended	recommended
U8557000	Three-Pole Protective Adaptor	–	–	–
U19106	Auxiliary Coil	–	–	–
U17250	Electroscope	–	–	–

Dual Beam Tube D

Part evacuated electron tube, filled with helium at low pressure, with tangential and axial electron gun. For determining specific charge e/m from the diameter of the filament beam in the case of tangential bombardment and a perpendicularly aligned magnetic field, and observing spiral paths of electrons in the case of axial bombardment and a co-axial magnetic field. The electron paths are rendered visible in the form of fine luminescent beams through impact excitation of the helium atoms.

- Max. filament voltage: 7.5 V
- Max. anode voltage: 100 V DC
- Anode current: approx. 30 mA
- Max. deflection voltage: 50 V DC
- Glass bulb: approx. 130 mm diam.
- Total length: approx. 260 mm

U19170

Additionally required:

U191001 Tube Holder D

U138101 Set of Leads for Electron Tube Experiments

U191051 Helmholtz Pair of Coils D

U33000-230 DC Power Supply, 0 – 500 V (230 V, 50/60 Hz)

or

U33000-115 DC Power Supply, 0 – 500 V (115 V, 50/60 Hz)

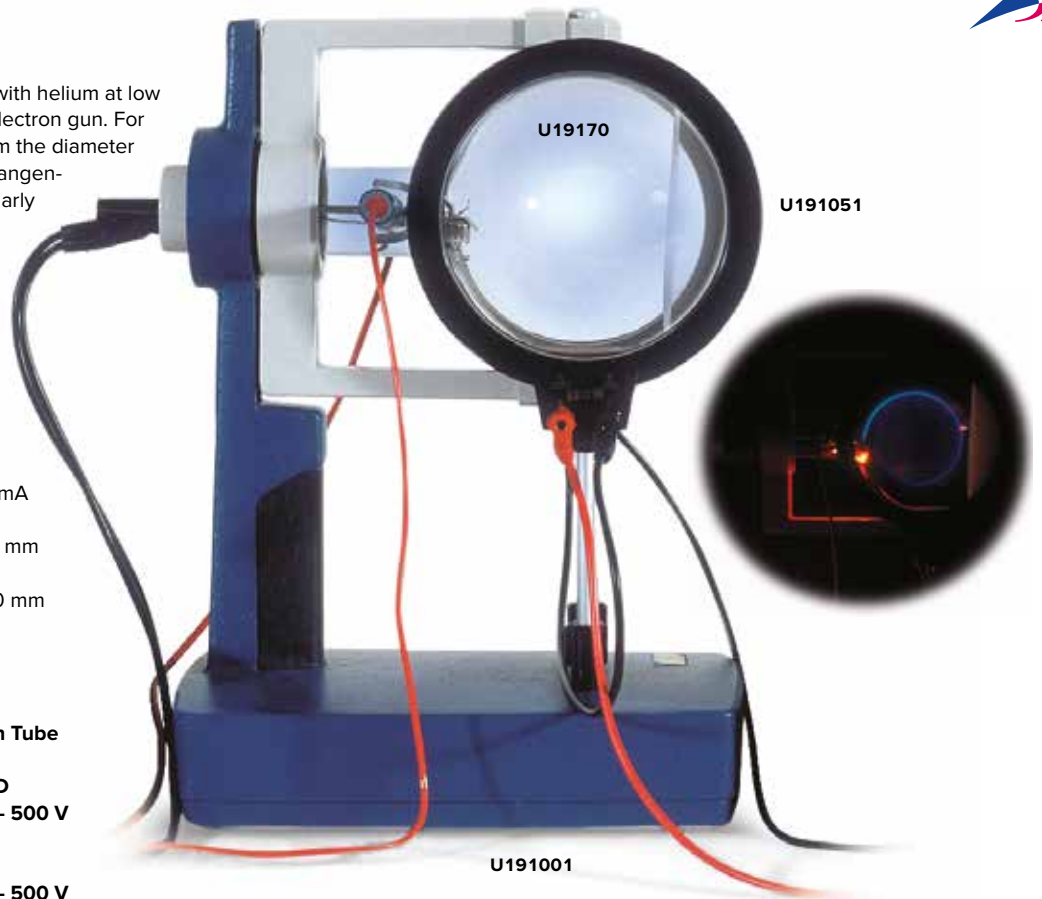

Free Electrons in Gases and in Vacuum

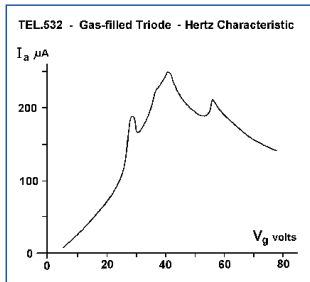

U19157: Anode current I_A as a function of the anode voltage U_A at different grid voltages U_G

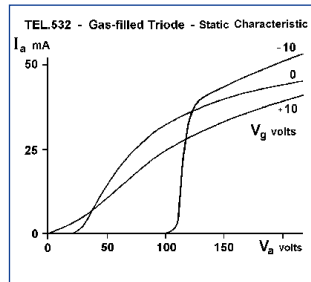

U19157: Electron collision excitation in Helium as a function of the acceleration voltage U_G

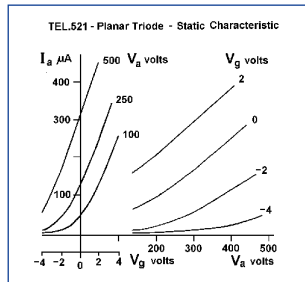

U19151: Anode current I_A as a function of the grid voltage U_G and as a function of the anode voltage U_A at different grid voltage U_G

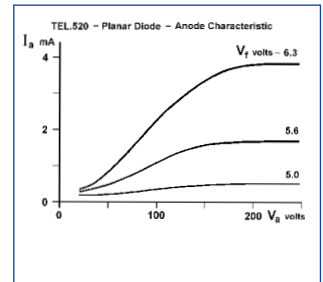

U191501: Anode current I_A as a function of the anode voltage U_A

U19170	U19152	U19153	U19154	U19155	U191711
Dual Beam Tube D	Luminescence Tube D	Maltese Cross Tube D	Perrin Tube D	Electron Deflection Tube D	Electron Diffraction Tube D
required	required	required	required	required	required
required	required	required	required	required	required
required	–	–	–	–	–
–	required	required	required	2x required	required
required	–	recommended	required	required	–
–	–	recommended	required	required	–
–	–	–	–	–	–
–	recommended	recommended	recommended	recommended	–
–	–	–	–	–	recommended
–	–	–	recommended	–	–
–	–	–	recommended	–	–

Electricity and Magnetism



U191001

Tube Holder D

Tube holder made of robust plastic for holding electron tubes of the D series and the optical equivalent (U19172). With 360° rotating clamp made of heat-resistant plastic and two holes for fixing the Helmholtz coil pair D (U191051).

On rubber feet to prevent slipping.

Dimensions: approx. 230x175x320 mm³

Weight: approx. 1.5 kg

U191001

Auxiliary Coil

Extra coil for generating an additional magnetic field in a Perrin tube, for example, to demonstrate the principle of an oscilloscope and for generating Lissajou's figures.

Number of turns: 1000

DC resistance: approx. 7 Ω

Load rating: max. 2 A

Connections: 4 mm jacks

Dimensions: approx. 33 mm x 80 mm diam.

U19106

Optical Equivalent to Debye-Scherrer Interference

Aluminium disc with ball bearing mounted optical lattice grating for illustrating the principle of Debye-Scherrer interference using visible light. The rotating lattice grating serves as a model for the polycrystalline graphite lattice in the electron diffraction tube. Includes an aperture and red and green colour filters.

Cross lattice: 20 grid points/mm, 3 mm diam.

Flywheel: 100 mm diam.

Pinhole aperture: 1 mm dia.

Aperture frame: approx. 50x50 mm²

Filter: approx. 80x100 mm²

U19172

Additionally recommended:

U191001 Tube Holder D

U21881 Optical Lamp

U13900-230 Transformer 12 V, 60 VA (230 V, 50/60 Hz)

or

U13900-115 Transformer 12 V, 60 VA (115 V, 50/60 Hz)

U17102 Convex Lens, f = 100 mm

U8474000 Object Holder on Stem

U17130 Projection Screen

U13270 Tripod Base

U8611210 Barrel Foot (3x)

Protective Adaptor, 3-Pole

Adaptor for electron diffraction tube D (U19171) for connection of the heater voltage via safety experiment leads. Includes internal protective circuitry to protect the heating filament against excess voltage. Dimensions match the three-pole connector for the tube.

U8557000

Protective Adaptor, 2-Pole

Adaptor for electron tubes D for connection of the heater voltage via safety experiment leads. Includes internal protective circuitry to protect the heating filament against excess voltage. Dimensions match the two-pole connector for the tubes.

U8557001



U19106

U191051

Helmholtz Pair of Coils D

Pair of coils for generating a uniform magnetic field perpendicular to the axis of a tube when using the tube holder D (U191001).

In plastic sleeve on an insulated stand rod.

Coil diameter: 136 mm

Number of turns: 320 each

Effective resistance: approx. 6.5 Ω each

Load rating: 1.5 A each

Terminals: 4 mm sockets

Rod: approx. 145 mm x 8 mm diam.

U191051

Additionally recommended:

U33020-230 DC-Power Supply 0 – 20 V, 0 – 5 A (230 V, 50/60 Hz)

or

U33020-115 DC-Power Supply 0 – 20 V, 0 – 5 A (115 V, 50/60 Hz)



U19172

Experiment topics:

- Thermionic emission of electrons
- Linear propagation of electrons in field free spaces
- Deflection in magnetic and electric fields
- Determination of the polarity of electron charges
- Determination of specific charge e/m
- Luminescence
- Excitation spectra of noble gases
- Inelastic electron collisions
- Resolution of primary and secondary quantum numbers of atomic excitation levels
- Wave and particle nature of electrons

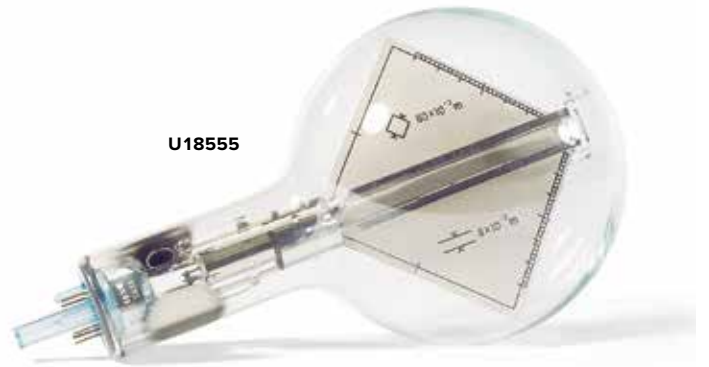

U18555

Thomson Tube S

Highly evacuated electron tube with focusing electron gun and fluorescent screen inclined relative to the beam axis, so that the path of the beam can be seen and the effects of electric and magnetic fields can be studied. The electron beam can be deflected electrically in the electric field of the built-in plate capacitor, and magnetically by using the Helmholtz coil pair S (U185051). By adjusting the electric field so that it cancels the magnetic deflection, it is possible to determine the specific charge e/m and the velocity of the electrons.

Filament voltage:	6.3 V AC
Max. anode voltage:	5000 V
Anode current:	approx. 0.1 mA at 4000 V
Max. Capacitor voltage:	500 V
Glass bulb:	approx. 130 mm diam.
Total length:	approx. 250 mm

U18555

Additionally required:

U185002 Tube Holder S

U138021 Set of 15 Safety Experiment Leads, 75 cm

U185051 Helmholtz Pair of Coils S

U33010-230 High Voltage Power Supply, 5 kV (230 V, 50/60 Hz)

U33000-230 Power Supply, 500 V DC (230 V, 50/60 Hz)

or

U33010-115 High Voltage Power Supply, 5 kV (115 V, 50/60 Hz)

U33000-115 Power Supply, 500 V DC (115 V, 50/60 Hz)

TELTRON® Electron Tubes S

Known throughout the world, tried and trusted over many years: Electron tubes with thermionic cathodes for experimental investigations of the properties of the free electron.

- Thermionic emission of electrons
- Linear propagation of electrons in field free spaces
- Deflection in magnetic and electric fields
- Determination of the polarity of electron charges
- Determination of specific charge e/m
- Luminescence
- Excitation spectra of noble gases
- Inelastic electron collisions
- Resolution of primary and secondary quantum numbers of atomic excitation levels
- Wave and particle nature of electrons

There is no need to take precautions against ionising radiation, since it is not necessary to use a high voltage of more than 5 kV to operate the tubes

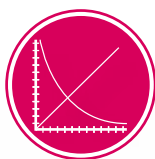

UE3070500
PDF online



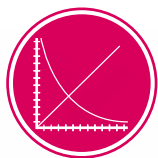

UE3070300
PDF online



U18553

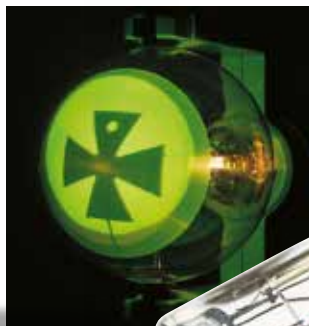

U18554

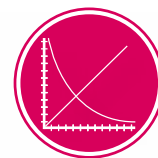

UE3070400
PDF online



Maltese Cross Tube S

Highly evacuated electron tube with divergent electron gun, fluorescent screen and Maltese cross. For demonstrating the straight line propagation of electrons in the absence of any electric or magnetic field by projecting the shadow of a Maltese cross onto the fluorescent screen and for introducing students to electron optics.

- Filament voltage: 6.3 V AC
- Max. anode voltage: 5000 V
- Anode current: approx. 0.1 mA at 4000 V
- Glass bulb: approx. 130 mm diam.
- Luminescent screen: approx. 85 mm diam.
- Total length: approx. 250 mm

U18553

Additionally required:

- U185002 Tube Holder S**
- U138021 Set of 15 Safety Patch Cords, 75 cm**
- U33010-230 High Voltage Power Supply, 5 kV (230 V, 50/60 Hz)**
- or
- U33010-115 High Voltage Power Supply, 5 kV (115 V, 50/60 Hz)**

Additionally recommended:

- U185051 Helmholtz Pair of Coils S**
- U33020-230 DC-Power Supply 0 – 20 V, 0 – 5 A (230 V, 50/60 Hz)**
- or
- U33020-115 DC-Power Supply 0 – 20 V, 0 – 5 A (115 V, 50/60 Hz)**

Luminescence Tube S

Highly evacuated electron tube with divergent electron gun and three fluorescent strips in red, green and blue. For demonstrating stimulated light emission during and after electron bombardment.

- Filament voltage: 6.3 V AC
- Max. anode voltage: 5000 V
- Anode current: approx. 0.1 mA at 4000 V
- Glass bulb: approx. 130 mm diam.
- Total length: approx. 250 mm

U18552

Additionally required:

- U185002 Tube Holder S**
- U138021 Set of 15 Safety Patch Cords, 75 cm**
- U33010-230 High Voltage Power Supply, 5 kV (230 V, 50/60 Hz)**
- or
- U33010-115 High Voltage Power Supply, 5 kV (115 V, 50/60 Hz)**

Perrin Tube S

Highly evacuated electron tube with focusing electron gun, fluorescent screen, and Faraday cage positioned on one side. For demonstrating the negative polarity of electrons and estimating the specific electron charge (charge to mass ratio) e/m by magnetic deflection into the Faraday cage, which is connected to an electroscopes (U17250). It is also possible to investigate the deflection of electrons by two alternating magnetic fields at right-angles to each other or by parallel electric and magnetic fields and to demonstrate the effects, for example by generating Lissajous figures.

- Filament voltage: 6.3 V AC
- Max. anode voltage: 5000 V
- Anode current: approx. 0.1 mA at 4000 V
- Beam current: 4 μ A at 4000V
- Glass bulb: approx. 130 mm diam.
- Luminescent screen: approx. 85 mm diam.
- Total length: approx. 250 mm

U18554

Additionally required:

- U185002 Tube Holder S**
- U138021 Set of 15 Safety Patch Cords, 75 cm**
- U185051 Helmholtz Pair of Coils S**
- U33010-230 High Voltage Power Supply, 5 kV (230 V, 50/60 Hz)**
- U33020-230 DC-Power Supply 0 – 20 V, 0 – 5 A (230 V, 50/60 Hz)**
- or
- U33010-115 High Voltage Power Supply, 5 kV (115 V, 50/60 Hz)**
- U33020-115 DC-Power Supply 0 – 20 V, 0 – 5 A (115 V, 50/60 Hz)**

Additionally recommended:

- U17250 Electroscopes**
- U19106 Auxiliary Coil**



U18552

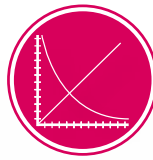

UE3070100
UE3070200
PDF online

U33000-230
U33000-115



U185002

U18551 / U18557



U17450

Diode S

Highly evacuated electron tube with thermionic cathode and anode for investigating the thermoelectric effect (Edison effect) and measuring the emission current as a function of the heating power applied to the cathode. Also for plotting diode characteristics and for demonstrating the rectifying effect of a diode.

- Max. heater voltage: 7.5 V AC/DC
- Max. anode voltage: 500 V
- Anode current: approx. 2 mA at 200 V Anode voltage
- Glass bulb: approx. 130 mm diam.
- Total length: approx. 250 mm

U185501

Additionally required:

- U185002 Tube Holder S**
- U138021 Set of 15 Safety Patch Cords, 75 cm**
- U17450 Analogue Multimeter AM50**
- U33000-230 Power Supply, 500 V DC (230 V, 50/60 Hz)**
- or
- U33000-115 Power Supply, 500 V DC (115 V, 50/60 Hz)**

Triode S

Highly evacuated electron tube with thermionic cathode, control grid and anode for quantitative investigation of controllable high vacuum tubes, plotting the characteristics of a triode, demonstrating the negative polarity of the electron charge, studying the practical applications of a triode as an amplifier and generating undamped oscillations in LC circuits

- Max. heater voltage: 7.5 V AC/DC
- Max. anode voltage: 500 V
- Anode current: approx. 2 mA at 200 V anode voltage
- Glass bulb: approx. 130 mm diam.
- Total length: approx. 250 mm

U18551

Additionally required:

- U185002 Tube Holder S**
- U138021 Set of 15 Safety Patch Cords, 75 cm**
- U17450 Analogue Multimeter AM50**
- U33000-230 Power Supply, 500 V DC (230 V, 50/60 Hz)**
- or
- U33000-115 Power Supply, 500 V DC (115 V, 50/60 Hz)**

Gas Triode S

Electron tube filled with low pressure helium gas resp. neon gas, with thermionic cathode, control grid, and anode for quantitative investigations of the typical properties of a gas-filled triode, recording the $I_A - U_A$ characteristics of a thyatron, observing independent and dependent discharges as well as discontinuous energy release of He or Ne atoms during inelastic collisions with free electrons.

- Max. heater voltage: 7.5 V AC/DC
- Max. anode voltage: 500 V
- Anode current: approx. 10 mA at 200 V anode voltage
- Glass bulb: approx. 130 mm diam.
- Total length: approx. 250 mm

Gas Triode S with He Filling

U18557

Gas Triode S with Ne Filling

U18558

Additionally required:

- U185002 Tube Holder S**
- U138021 Set of 15 Safety Patch Cords, 75 cm**
- U17450 Analogue Multimeter AM50**
- U33000-230 Power Supply, 500 V DC (230 V, 50/60 Hz)**
- or
- U33000-115 Power Supply, 500 V DC (115 V, 50/60 Hz)**



U185501

U18551 /
U18557 /
U18558

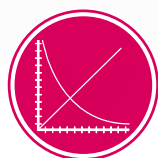

U185711

UE5010500
 PDF online

Dual Beam Tube S

Partly evacuated electron tube, filled with helium at low pressure, with tangential and axial electron gun. For determining specific charge e/m from the diameter of the filament beam in the case of tangential bombardment and a perpendicularly aligned magnetic field, and observing spiral paths of electrons in the case of axial bombardment and a co-axial magnetic field. The electron paths are rendered visible in the form of fine luminescent beams through impact excitation of the helium atoms.

Max. filament voltage:	7.5 V AC/DC
Max. anode voltage:	100 V DC
Anode current:	approx. 30 mA
Max. deflection voltage:	50 V DC
Glass bulb:	approx. 130 mm diam.
Total length:	approx. 250 mm

U18570

Additionally required:

- U185002 Tube Holder S**
- U138021 Set of 15 Safety Patch Cords, 75 cm**
- U185051 Helmholtz Pair of Coils S**
- U33000-230 Power Supply, 500 V DC (230 V, 50/60 Hz)**
- or
- U33000-115 Power Supply, 500 V DC (115 V, 50/60 Hz)**

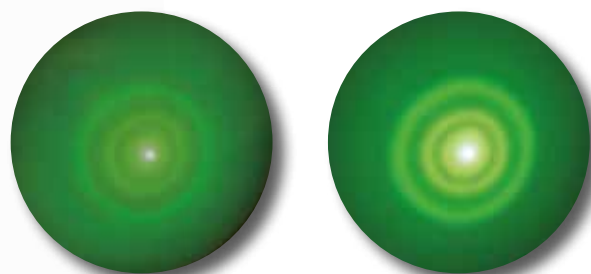

Recording in a darkened room with 3 kV and 4,5 kV.

Electron Diffraction Tube S

Highly evacuated electron tube for demonstrating the wave nature of electrons through the observation of interference caused by passage of electrons through a polycrystalline graphite lattice (Debye-Scherrer diffraction) and rendered visible on a fluorescent screen. Also intended for determining the wavelength as a function of the anode voltage from the radii of the diffraction rings and the lattice plane spacing of graphite, as well as confirming de Broglie's hypothesis.

Filament voltage:	6.3 V AC
Max. anode voltage:	5000 V
Anode current:	approx. 0.1 mA at 4000 V
Lattice constant of graphite:	$d_{10} = 0.213 \text{ nm}$, $d_{11} = 0.123 \text{ nm}$

U185711

Additionally required:

- U185002 Tube Holder S**
- U138021 Set of 15 Safety Experiment Leads, 75 cm**
- U33010-230 High Voltage Power Supply, 5 kV (230 V, 50/60 Hz)**
- or
- U33010-115 High Voltage Power Supply, 5 kV (115 V, 50/60 Hz)**



U18570

		U185501	U18551	U18557	U18558
		Diode S	Triode S	Gas Triode S with He Filling	Gas Triode S with Ne Filling
U185002	Tube Holder S	required	required	required	required
U138021	Set of 15 Safety Patch Cords, 75 cm	required	required	required	required
U13761	Experiment Lead, Safety Plug and Socket	–	–	–	–
U33000-230 or U33000-115	Power Supply, 500 V DC	required	required	required	required
U33010-230 or U33010-115	High Voltage Power Supply, 5 kV	–	–	–	–
U185051	Helmholtz Pair of Coils S	–	–	–	–
U33020-230 or U33020-115	DC-Power Supply, 20 V	–	–	–	–
U17450	Analogue Multimeter AM50	required	required	required	required
U19106	Auxiliary Coil	–	–	–	–
U17250	Electroscope	–	–	–	–

Tube Holder S

Tube holder to support all S series electron tubes for easy and safe operation. The five pin sockets for the tube are concealed inside the tube holder. A cathode protection switch is integrated into the tube holder, to protect the heated cathode from excessive voltage. The base plate has a slot for attaching the Helmholtz pair of coils S (U185051).

Terminals : 4 mm safety sockets
 Dimensions: approx. 130x190x250 mm³
 Weight: approx. 570 g

U185002



U185002

Replacement Circuit Board for Tube Holder S

The quality of the electron beam in electron defraction tube S (U185711) is affected by the resistance between sockets C5 (cathode) and F4 (heating filament) on the tube. For optimum results, the resistance needs to be 390 kΩ. Tube holder S (U185002) is accordingly designed such that this resistance is present. Older designs feature a much smaller resistance and need to be modified in order to work with the new S-series electron deflection tube (U185711).
 Tube holders affected: U18500, U185001, 1000610

U999999-611



U999999-611

Helmholtz Pair of Coils S

Pair of coils for generating a uniform magnetic field perpendicular to the axis of a tube when using the tube holder S (U185002).

Number of turns: 320 each
 Coil diameter: 138 mm each
 Load rating: 1.0 A (Continuous operation) each
 1.5 A (Short-term operation)
 Effective Resistance: approx. 6,5 Ω each
 Terminals: 4 mm safety sockets

U185051

Additionally recommended:

U33020-230 DC-Power Supply 0 – 20 V, 0 – 5 A
 (230 V, 50/60 Hz)

or

U33020-115 DC-Power Supply 0 – 20 V, 0 – 5 A
 (115 V, 50/60 Hz)



U185051

U18570	U18552	U18553	U18554	U18555	U185711	U18580
Dual Beam Tube S	Luminescence Tube S	Maltese Cross Tube S	Perrin Tube S	Thomson Tube S	Electron Defraction Tube S	Gas Discharge Tube S
required	required	required	required	required	required	required
required	required	required	required	required	required	–
–	–	–	–	–	–	2x required
required	–	–	–	required	–	–
–	required	required	required	required	required	required
required	–	recommended	required	required	–	–
–	–	recommended	required	–	–	–
–	–	–	–	–	–	–
–	–	–	recommended	–	–	–
–	–	–	recommended	–	–	–



U18580

Gas Discharge Tube

Evacuatable glass tube for observation of luminous effects of electrical discharges in gases under reduced pressure. Glass tube with graded seal, disc shaped, perforated electrodes and 4 mm jacks for connecting the voltage supply.

Material: glass
 Dimensions: approx. 700 mm x 40 mm diam.
 Vacuum connection: graded seal NS 19/26

U14380

Gas Discharge Tube S

Evacuatable glass tube with fluorescent screens at both ends for observation of electrical discharges in gases under reduced pressure as well as for investigation of cathode beams and canal rays, which appear at low pressure outside the discharge path. Demountable design, installation in tube holder (U185002). Includes a needle ventilation valve and vacuum hoses.

Length: approx. 280 mm
 Polarization voltage: ≤ 5 kV
 Discharge current: approx. 1.2 mA
 Connections: 4 mm contact pins

U18580

Additionally required:

U185002 Tube Holder S

U13761 Experiment Lead, Safety Plug and Socket (2x)

U34000 Rotary-Vane Vacuum Pump, Two-Stage

U33010-230 High Voltage Power Supply, 5 kV (230 V, 50/60 Hz)

or

U33010-115 High Voltage Power Supply, 5 kV (115 V, 50/60 Hz)

Additionally recommended:

U33010-230 High Voltage Power Supply, 5 kV (230 V, 50/60 Hz)

or

U33010-115 High Voltage Power Supply, 5 kV (115 V, 50/60 Hz)

U14501-230 Rotary Vane Pump P 4 Z

U145051-230 Pirani Vacuum Gauge

U14510 2-Way Ball Valve DN 16 KF

U14511 Crosspiece DN 16 KF

U14516 Adaptor Flange DN 16 – Core NS 19/26

U14513 Ventilation Valve DN 16 KF

U14517 Tension Ring DN 10/16 KF (5x)

U14518 KF External Centring Ring DN 10/16 KF (5X)

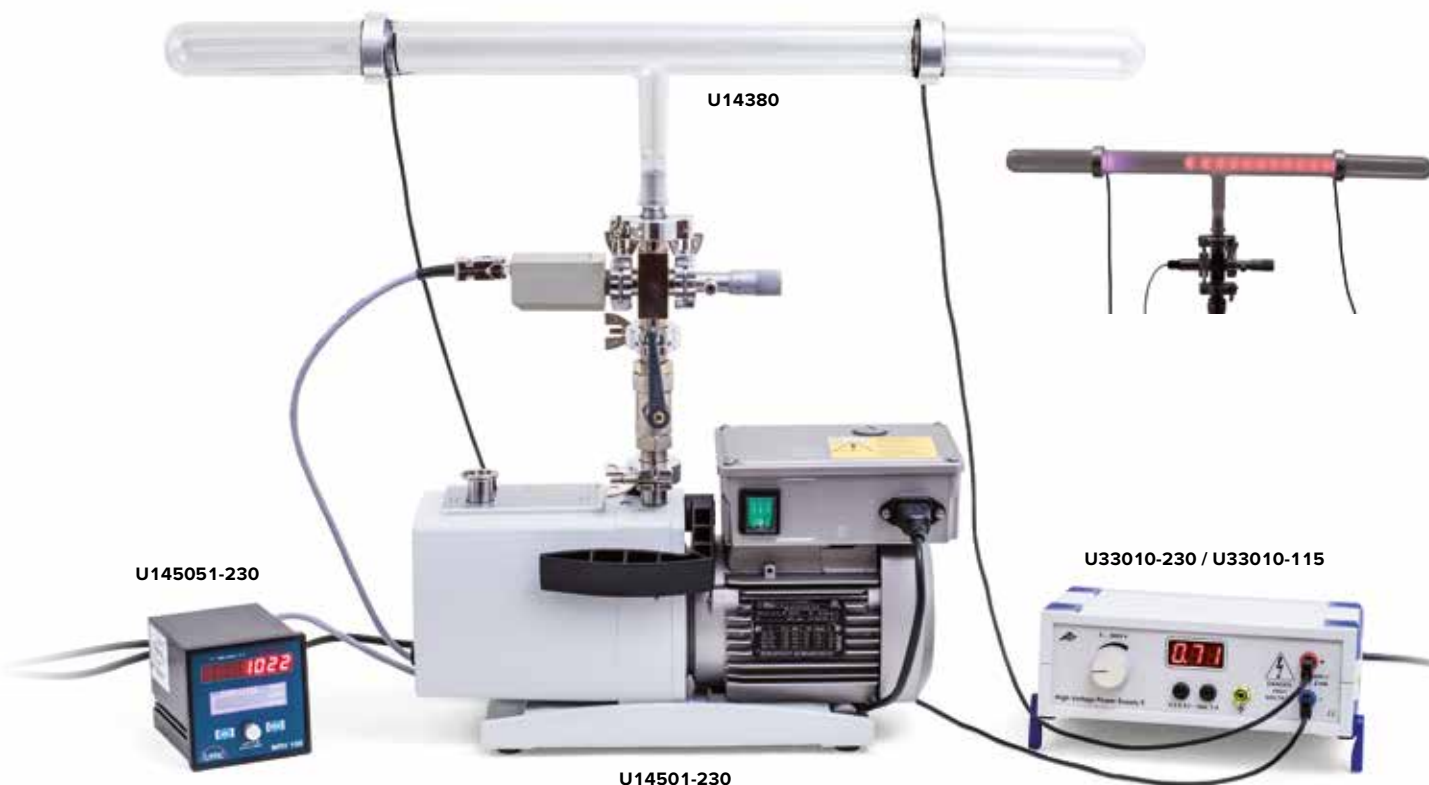

U145051-230

U14380

U14501-230

U33010-230 / U33010-115

Experiment topics:

- Linear propagation of electrons in a zero-field space
- Deflection of electron beams in an electrical field
- Deflection of electron beams in a magnetic field
- Magnetic lens
- Phase displacement, superimposition of magnetic fields, Lissajous figures
- Determination of an electron's specific charge
- Determination of an electron's speed



Training Oscilloscope

Electron tube mounted on a terminal base for investigating the design and operation of a cathode ray tube. The electron beam can be deflected by an electric field produced by the deflection plates integrated into the tube, and by a magnetic field from three external coils mounted on a ring. A Wehnelt cylinder is used to focus the beam. The gas filling and the fluorescent screen make it possible to observe the beam in the tube. A continuously adjustable saw-tooth generator can be used to analyse and visualize time dependent processes. The device comes with a socket and printed wiring diagram.

Anode voltage:	250 – 350 V DC
Anode current:	1 mA
Filament voltage:	6 – 8 V AC/DC
Filament current:	0.3 A
Wehnelt voltage:	0 – 50 V DC
Deflection plate dimensions:	approx. 12x20 mm ²
Plate spacing:	approx. 14 mm

Electric deflection sensitivity:	0,2 mm/V
Screen diameter:	approx. 100 mm
Tube length:	approx. 260 mm
Residual gas:	Neon
Gas pressure:	10 ⁻⁴ hPa
Sweep frequency:	10 – 200 Hz, continuously adjustable
3 deflection coils:	600 turns each, with a centre pick up
Weight:	approx.1.6 kg

U8481350

Additionally recommended:

- U33000-230 DC Power Supply, 0 – 500 V (230 V, 50/60 Hz)**
- U8533600-230 Function Generator FG100 (230 V, 50/60 Hz)**
- or
- U33000-115 DC Power Supply, 0 – 500 V (115 V, 50/60 Hz)**
- U8533600-115 Function Generator FG100 (115 V, 50/60 Hz)**

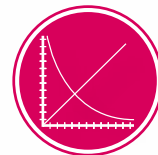
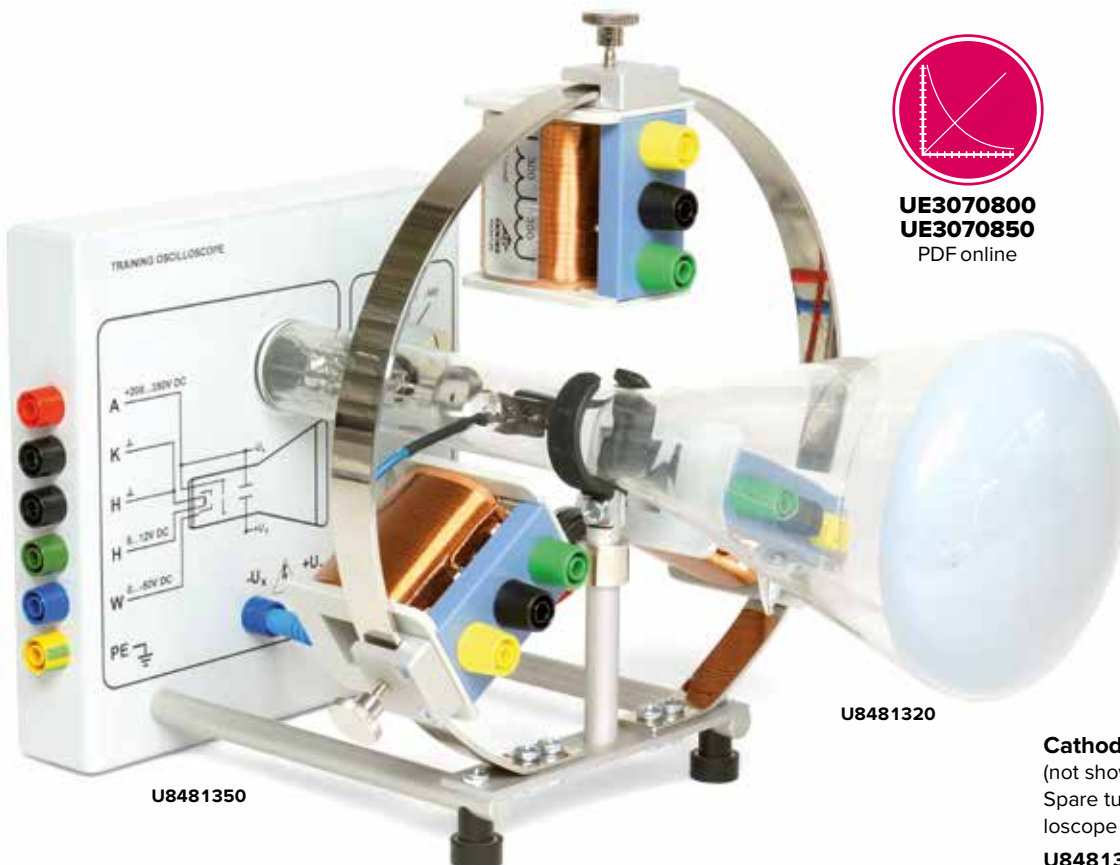

UE3070800
UE3070850
PDF online

U8481320

Cathode Ray Tube

(not shown)
Spare tube for the training oscilloscope (U8481350).

U8481320

Experiment topics:

- Deflection of electrons in a closed circular path inside a magnetic field
- Determination of specific charge of an electron e/m

Fine Beam Tube on Connection Base

For examining the deflection of electron beams in a uniform magnetic field using a pair of Helmholtz coils (U8481500) and for the quantitative determination of the specific charge of the electron e/m . Glass vessel with integrated electron beam system, consisting of an indirectly heated oxide cathode, a Wehnelt cylinder and a perforated anode, in neon residual gas atmosphere with precisely set gas pressure and with integrated measurement marks for parallax-free determination of the diameter of the fine beam. Gas atoms are ionized along the electron path and produce a sharply defined, visible fluorescent beam. Tube mounted on base with colour coded connectors.

Gas filling:	Neon
Gas pressure:	1.3×10^{-5} hPa
Filament voltage:	5 – 7 V DC
Filament current:	< 150 mA
Wehnelt voltage:	0 – -50 V
Anode voltage:	200 – 300 V
Anode current:	< 0.3 mA
Circular path diameter:	20 – 120 mm
Division spacing:	approx. 20 mm
Tube diameter:	approx. 160 mm
Dimensions:	approx. 115x115x35 mm ³
Weight:	approx. 820 g

U8481430

Additionally required:

U8481500 Helmholtz Coils, 300 mm

Additionally recommended:

U33000-230 DC Power Supply, 0 – 500 V (230 V, 50/60 Hz)

or

U33000-115 DC Power Supply, 0 – 500 V (115 V, 50/60 Hz)

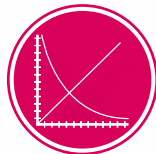
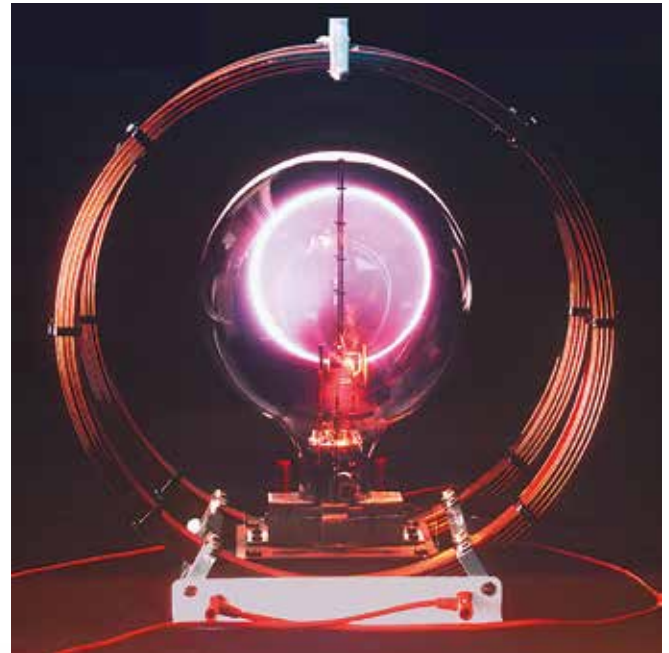

UE3070700
PDF online



Experiment topics:

- Electron deflection in a uniform magnetic field
- Closed orbit or spiral path
- Determining an electron's specific charge e/m

Complete Fine Beam Tube System

This complete experimental system is used to determine an electron's specific charge and investigate the deflection of electron beams in a uniform magnetic field. The system comes complete with a fine-beam tube, Helmholtz coil pair for generating a uniform magnetic field, and operating unit for power supply. The fine beam tube and Helmholtz coil pair are mounted on the operating unit, the fine beam tube being rotatable around its vertical axis. The tube and coil pair are both connected internally to the operating unit without a need for external wiring. All supply voltages for the tube and the current through the Helmholtz coils are adjustable. The anode voltage and coil current are displayed digitally and can be tapped additionally as equivalent voltage values. Inside the fine beam tube, a sharply delimited electron beam is generated by a system comprising an indirectly heated oxide cathode, perforated anode and Wehnelt cylinder. Impact ionization of helium atoms creates a very bright, also sharply delimited trace of the electron path in the tube. If the tube is aligned optimally and an appropriate current flows through the Helmholtz coils, the electrons are deflected into a circular orbit, whose diameter can be easily determined when the electrons strike one of the equidistant measurement marks, causing its end to light up. Diameter, anode voltage and magnetic field are the parameters used to determine the electron's specific charge. The magnetic field can be calculated from the coil current, the geometry of the Helmholtz coil pair being known.

Fine-beam tube:

Gas filling: Helium
 Gas pressure: 0.13 hPa
 Bulb diameter: 165 mm
 Orbit diameter: 20 – 120 mm
 Measurement mark spacing: 20 mm

Helmholtz coil pair:

Coil diameter: approx. 300 mm
 Winding count: 124
 Magnetic field: 0 – 3.4 mT (0.75 mT/A)

Operating unit:

Coil current: 0 – 4.5 A, 3-figure digital display
 Measurement output: 1 V*IB / A
 Anode voltage: 15 – 300 V, 3-figure digital display
 Measurement output: 0.01* UA
 Heating voltage: 5 – 7 V
 Wehnelt voltage: 0 – -50 V

General data:

Tube's rotary angle: -10° – 270°
 Supply voltage: 100 – 240 V, 50/60 Hz
 Power supply cable: EU, UK and US
 Dimensions: approx. 310x275x410 mm³
 Weight: approx. 7.5 kg

UL18575

The complete fine-beam tube system consists of the following parts:

Fine Beam Tube T

U18575

Operating Unit for Fine-Beam Tube

U8481425

Recording in a darkened room



Circular path



Spiral path



U8481425

Periodic Table of the Elements, with Electron Configurations

Chart of the periodic table of the elements showing the configurations of electron shells. On strong laminated material with rods and hanging cord. Bilingual.

Dimensions: 1950x1380 mm² approx.

Languages: English and German

U197001

Periodic Table of the Elements, with Pictures

Chart of the periodic table of the elements with pictures of the elements. On strong laminated material with rods and hanging cord. In four languages.

Dimensions: 1950x1380 mm² approx.

Languages: English, German, French, Spanish

U197051

PERIODENSYSTEM DER ELEMENTE																		PERIODIC TABLE OF THE ELEMENTS															
Hauptgruppen										Main Group Elements										Periode													
I		II																III	IV	V	VI	VII	VIII	IX	X	Periode							
1	H																	He	1														
2	Li	Be															B	C	N	O	F	Ne	2										
3	Na	Mg	Nebengruppen										Transition Elements										Al	Si	P	S	Cl	Ar	3				
4	K	Ca	Sc											Ti	V	Cr	Mn	Fe	Co	Ni	Cu	Zn	Ga	Ge	As	Se	Br	Kr	4				
5	Rb	Sr	Y	Lanthanoide und Actinoide										Zr	Nb	Mo	Tc	Ru	Rh	Pd	Ag	Cd	In	Sn	Sb	Te	I	Xe	5				
6	Cs	Ba	La	Ce	Pr	Nd	Pm	Sm	Eu	Gd	Tb	Dy	Ho	Er	Tm	Yb	Lu	Hf	Ta	W	Re	Os	Ir	Pt	Au	Hg	Tl	Pb	Bi	Po	At	Rn	6
7	Fr	Ra	Ac	Th	Pa	U	Np	Pu	Am	Cm	Bk	Cf	Es	Fm	Md	No	Lr	Rf	Db	Sg	Bh	Hs	Mt	Ds	Rg	Cn	Fl	Lv			7		

U197001

Periodensystem der Elemente																		Periodic System of the Elements										Système périodique des éléments										Sistema periódico de los elementos									
1	I (1)																VIII (18)																														
1	H																	He																													
2	Li	Be															B	C	N	O	F	Ne																									
3	Na	Mg																					Al	Si	P	S	Cl	Ar																			
4	K	Ca	Sc	Ti	V	Cr	Mn	Fe	Co	Ni	Cu	Zn	Ga	Ge	As	Se	Br	Kr																													
5	Rb	Sr	Y	Zr	Nb	Mo	Tc	Ru	Rh	Pd	Ag	Cd	In	Sn	Sb	Te	I	Xe																													
6	Cs	Ba	La	Ce	Pr	Nd	Pm	Sm	Eu	Gd	Tb	Dy	Ho	Er	Tm	Yb	Lu	Hf	Ta	W	Re	Os	Ir	Pt	Au	Hg	Tl	Pb	Bi	Po	At	Rn															
7	Fr	Ra	Ac	Th	Pa	U	Np	Pu	Am	Cm	Bk	Cf	Es	Fm	Md	No	Lr	Rf	Db	Sg	Bh	Hs	Mt	Ds	Rg	Cn	Fl	Lv																			

U197051



UE5010300
PDF online

Insight into the World of Atoms

Experiment topics:

- Tunnel effect
- Representation of individual atoms
- Representation of lattice defects and dislocations
- Representation of charge density waves
- Dependence of tunnel current on distance between measuring tip and sample
- PID control of tunnel current

MoS₂ Sample (not shown)

Molybdenum-sulphide sample on a carrier for observing defects in crystal lattices with the scanning tunnelling microscope.

U13914

TaS₂ Sample (not shown)

Tantalum-disulfide sample on a carrier for observing the distribution of surface charge density (stationary charge-density waves) with a scanning tunnelling microscope.

U13913

TaSe₂ Sample (not shown)

Tantalum-diselenide sample on a carrier for observing the distribution of surface charge density (stationary charge-density waves) with a scanning tunnelling microscope.

U13912

Representation of a gold surface

Representation of a TaS₂ surface by means of stationary charge-density waves

Representation of the hexagonal structure of a graphite surface

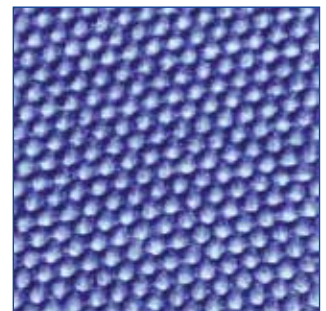
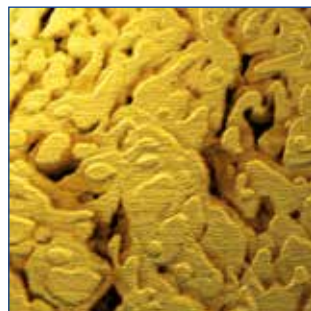

U13910

Scanning Tunnelling Microscope

Meant to resolve atomic structures at the surface of electrically conductive materials, this easy-to-use and compact, scanning tunnelling microscope is particularly suitable for training purposes. The complete system includes a probe for row-by-row scanning of sample surfaces with the measuring tip, vibration-absorbing pad, controller with computer interface, as well as graphite and gold samples.

System requirements: Windows 2000 or higher
 XYZ grid: 500x500x200 nm³
 Minimum increment XY: 7.6 µm
 Minimum increment Z: 3 µm
 Tunnel current: 0.100 – 100.000 nA (0.025 nA increment)
 Voltage: ±10.000 V (0.005 V increment)
 Maximum sample size: 10 mm diam.
 Supply voltage: 90 – 240 V, 50/60 Hz
 Connection: USB

Contents:

Controller
 Installation CD with measurement and control software
 Scanning probe with connection cable
 Cover with lens
 Experiment plate with vibration damping
 Tool kit for manufacturing the probe tip (side cutters, flat-nose pliers, pointed and rounded tweezers)
 Platinum-iridium wire, 0.25 mm diam., 300 mm
 Graphite (HOPG) sample on a carrier
 Gold (1.1) sample on a carrier
 Set of 4 sample carriers

U13910

WSe₂ Sample (not shown)

Tungsten-diselenide sample on a carrier for observing surface defects with a scanning tunnelling microscope.

U13911

Platinum-Iridium Wire (not shown)

Platinum-iridium wire, 0.25 mm Ø, 300 mm as spare wire for manufacturing measuring tips for the scanning tunnelling microscope.

U13915

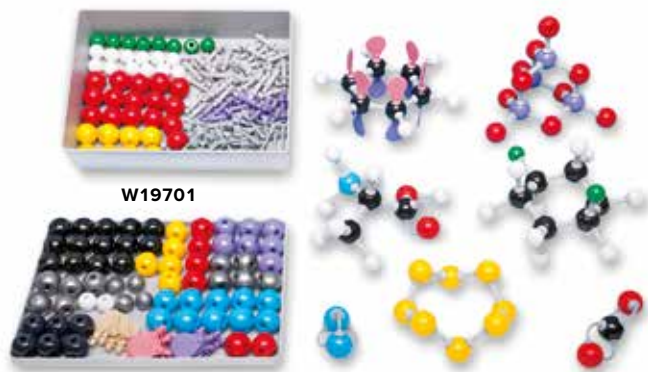

W19701

Organic/Inorganic Molecule Set D

Molecule building set for assembling three-dimensional models of organic and inorganic molecules and for clarification of their spatial configurations. Many chemical compounds can be represented clearly. These include simple molecules such as hydrogen, oxygen and water, organic compounds such as ethane, ethene, ethyne, benzene, alanine, glucose, and cyclohexane and also more complex structures such as the tetrammino zinc ion or tetraphosphorous decoxide.

W19701

Contents:

Atoms					
14	C	black	4 wholes	tetrahedral	109°
6	C	dark blue	5 wholes	tribipyramidal	90°, 120°
12	H	white	1 whole	one sided	
2	H	white	1 whole	linear	180°
16	O	red	2 wholes	angular	105°
6	O	red	4 wholes	tetrahedral	109°
6	N	blue	4 wholes	tetrahedral	109°
4	N	blue	3 wholes	pyramidal	107°
4	S	yellow	4 wholes	tetrahedral	109°
1	S	yellow	6 wholes	octahedral	90°
8	S	yellow	2 wholes	angular	105°
8	Cl, (F)	green	1 wholes	one sided	
4	P	purple	4 wholes	tetrahedral	109°
1	P	purple	5 wholes	tribipyramidal	90°, 120°
2	P	purple	3 wholes	pyramidal	107°
4	Na	grey	1 whole	one sided	
3	Ca, Mg	grey	2 wholes	angular	105°
2	Al	grey	3 wholes	trigonal	120°
4	Si, Cu	grey	4 wholes	tetrahedral	109°
1	metal atom	grey	6 wholes	octahedral	90°

Electron clouds		
6	lone pair	light beige
6	unhybridised p-lobe	purple
6	unhybridised p-lobe	pink

Links		
38	medium	light grey
12	medium	purple
36	long, flexible	grey



W19721

Organic Molecule Set S

Molecule building set for assembling three-dimensional models of organic molecules and for clarification of their spatial configurations. Many chemical compounds can be represented clearly and phenomena such as structural isomerism, optical isomerism and geometric isomerism can be illustrated. The spectrum ranges from simple molecules such as alkanes, alkenes and alkynes, alcohols, aldehydes, ketones, carboxylic acids, esters, ethers, halogenated compounds, amines, amides, cycloalkanes to biochemical molecules, amino acids, aromatic molecules and polymers.

W19721

Contents:

Atoms					
12	C	black	4 wholes	tetrahedral	109°
20	H	white	1 whole	one sided	
6	O	red	2 wholes	angular	105°
2	N	blue	4 wholes	tetrahedral	109°
2	N	blue	3 wholes	pyramidal	107°
1	S	yellow	4 wholes	tetrahedral	109°
1	S	yellow	6 wholes	octahedral	90°
4	Cl, (F)	green	1 whole	one sided	
1	P	purple	4 wholes	tetrahedral	109°
1	Na	grey	1 whole	one sided	

Links		
26	short	white
6	medium	light grey
12	long, flexible	grey



U40030

Set of 3 Carbon Configurations

Set of 3 easy-to-use models of various carbon crystal structures: diamond, graphite and fullerene, for demonstrating the fundamental differences between the structures.

Ball diameter: 25 mm approx.

Lengths of sides: 150 mm approx.

U40030

W19722



Organic/Inorganic Molecule Set S

Molecule building set for assembling three-dimensional models of organic and inorganic molecules and for clarification of their spatial configurations. Many chemical compounds can be represented clearly. These include inorganic molecules such as hydrogen, oxygen, water, acids, salts, metal oxides, and non metal oxides and also organic compounds such as ethane, ethene, ethyne, benzene, alanine, glucose, and cyclohexane.

W19722

Contents:

Atoms					
6	C	black	4 wholes	tetrahedral	109°
14	H	white	1 whole	one sided	
6	O	red	2 wholes	angular	105°
1	O	red	4 wholes	tetrahedral	109°
2	N	blue	4 wholes	tetrahedral	109°
1	N	blue	3 wholes	pyramidal	107°
1	S	yellow	4 wholes	tetrahedral	109°
1	S	yellow	6 wholes	octahedral	90°
6	Cl, (F)	green	1 wholes	one sided	
1	P	purple	5 wholes	tribipyramidal	90°, 120°
1	P	purple	3 wholes	pyramidal	107°
2	Na	grey	1 wholes	one sided	
2	Ca, Mg	grey	2 wholes	angular	105°
1	Be	grey	2 wholes	linear	180°
1	Al	grey	3 wholes	trigonal	120°
1	Si, Cu	grey	4 wholes	tetrahedral	109°
1	metal atom	grey	6 wholes	octahedral	90°
1	B	light beige	3 wholes	trigonal	120°
1	atom	beige	4 wholes	tetrahedral	109°
1	atom	beige	5 wholes	tribipyramidal	90°, 120°
1	atom	beige	6 wholes	octahedral	90°

Electron clouds

3	lone pair	light beige
---	-----------	-------------

Links

20	medium	light grey
5	medium	purple
12	lang flexibel	grey

Set 14 Bravais Lattices

Set of easy to handle models of the 14 fundamental lattice types (Bravais lattices), from which Auguste Bravais postulated that practically all naturally occurring crystal lattices can be derived by shifting along the axes. Made of wooden balls in six different colours connected via metal rods. The six colours distinguish the six different systems into which the lattice types are categorised.

Diameter of balls: 25 mm approx.
Length of sides: 150 mm approx.

U40020

3bscientific.com

W19700



Organic Molecule Set D

Molecule building set for assembling three-dimensional models of organic molecules and for clarification of their spatial configurations. Many chemical compounds can be represented clearly and phenomena such as structural isomerism, optical isomerism and geometric isomerism can be illustrated. The spectrum ranges from simple molecules such as alkanes, alkenes and alkynes, alcohols, aldehydes, ketones, carboxylic acids, esters, ethers, halogenated compounds, amines, amides, cycloalkanes to biochemical molecules, amino acids, aromatic molecules and polymers.

W19700

Contents:

Atoms					
24	C	black	4 wholes	tetrahedral	109°
6	C	dark grey	3 wholes	trigonal	120°
2	C	dark grey	2 wholes	linear	180°
6	C	dark blue	5 wholes	tribipyramidal	90°, 120°
40	H	white	1 whole	one sided	
12	O	red	2 wholes	angular	105°
4	N	blue	4 wholes	tetrahedral	109°
1	S	yellow	4 wholes	tetrahedral	109°
1	S	yellow	2 wholes	angular	105°
8	Cl, (F)	green	1 whole	one sided	
4	P	purple	4 wholes	tetrahedral	109°
2	Na	grey	1 whole	one sided	
1	Ca, Mg	grey	2 wholes	angular	105°

Electron clouds

6	lone pair	light beige
6	unhybridised p-lobe	purple
6	unhybridised p-lobe	pink

Links

60	short	white
55	medium	light grey
25	long, flexible	grey

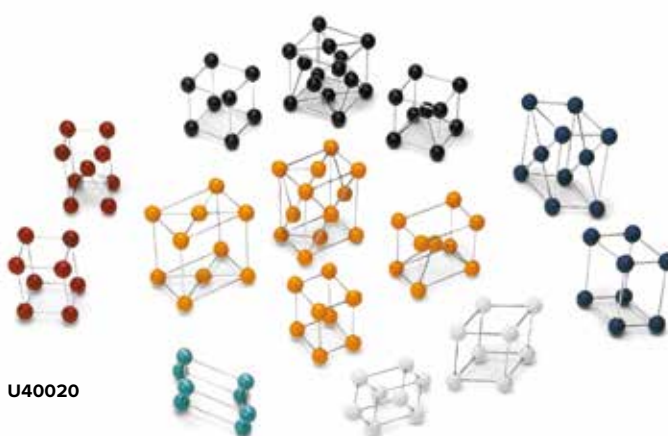

U40020

3B Scientific® Physics

Hands-on atomic shells!

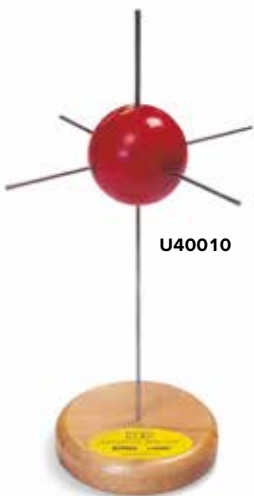

U40010

s-Orbital

Three-dimensional model of the s-orbital in the wave functions of hydrogen. With base. Made of hard wood mounted on a nickel coated steel axle.
Height: 250 mm approx.

U40010

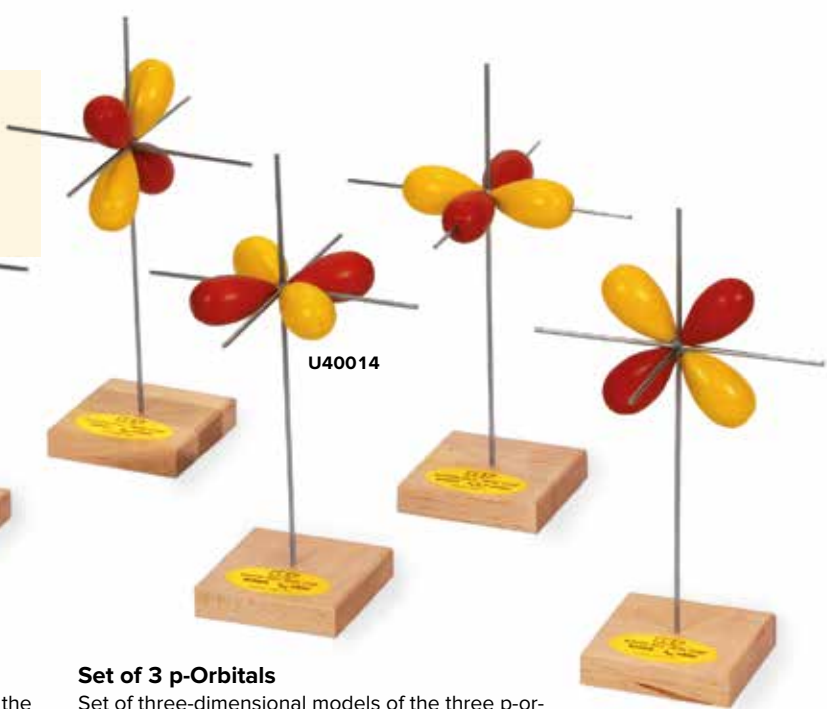

U40014

Set of 3 p-Orbitals

Set of three-dimensional models of the three p-orbitals in the wave functions of hydrogen. With base. Made of hard wood mounted on a nickel coated steel axle. Two colours to indicate the change in sign in the wave functions.
Height: 250 mm approx.

U40012

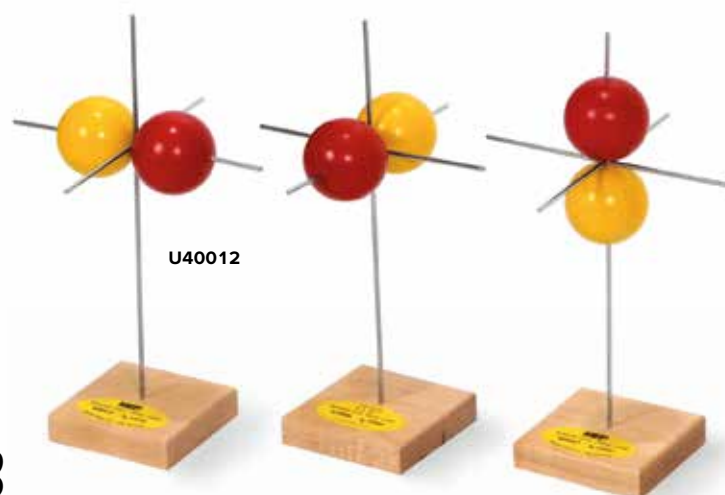

U40012

Set of 5 d-Orbitals

Set of three-dimensional models of the five d-orbitals in the wave functions of hydrogen. With base. Made of hard wood mounted on a nickel coated steel axle. Two colours to indicate the change in sign in the wave functions.
Height: 250 mm approx.

U40014

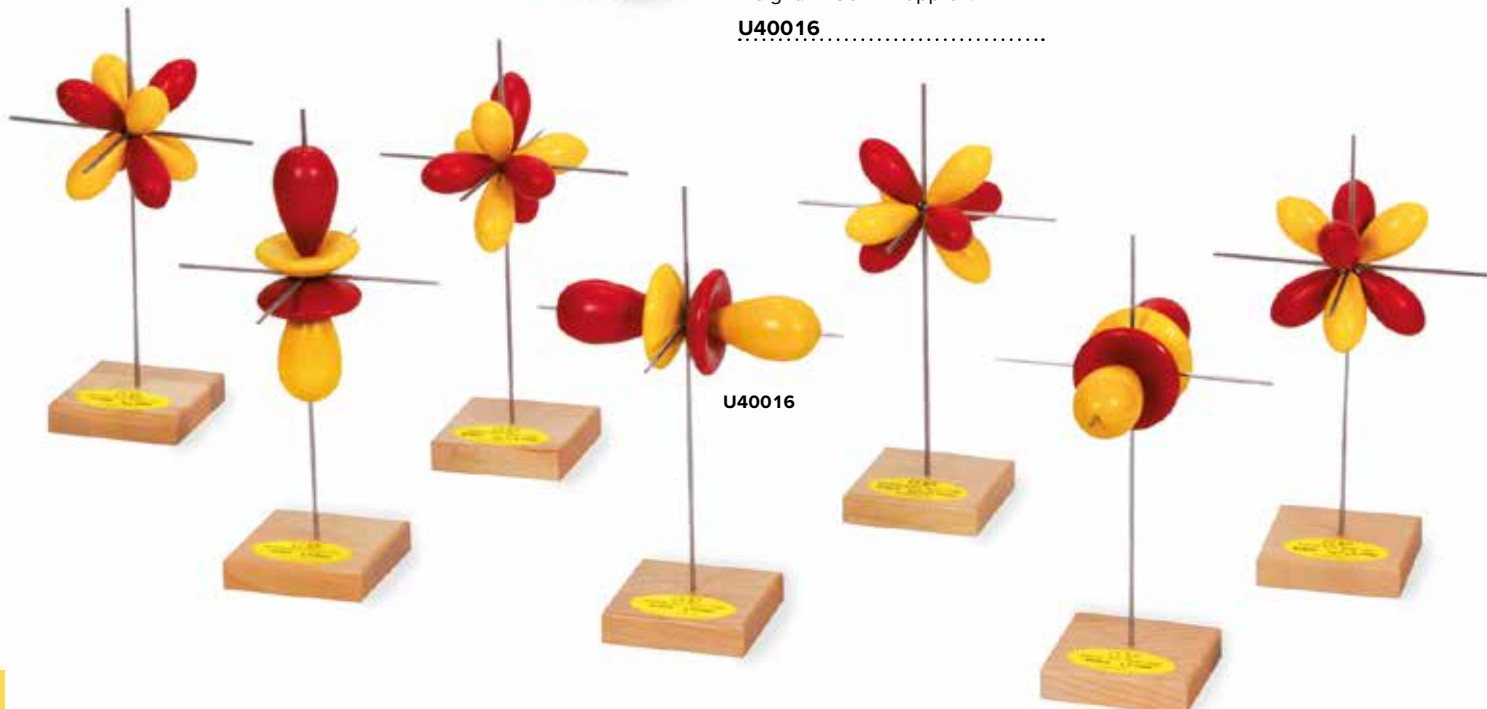

U40016

Set of 7 f-Orbitals

Set of three-dimensional models of the seven f-orbitals in the wave functions of hydrogen. With base. Made of hard wood mounted on a nickel coated steel axle. Two colours to indicate the change in sign in the wave functions.
Height: 250 mm approx.

U40016

Experiment topics:

- Millikan's experiment
- Discrete nature (quantisation) of electric charge
- Elementary electric charge
- Charged oil droplets in an electric field
- Stokes viscous drag, weight, buoyancy
- Equilibrium voltage
- Velocity of fall and velocity of rise

Advantages

- Compact instrument with built-in measurement and display unit
- Touch-sensitive screen for simple and ergonomic operation
- Maintenance-free lighting unit for uniform lighting via two green LEDs
- Built-in pressure and temperature sensor for automatically determining the relevant parameters, temperature, viscosity and pressure



U20700-230
U20700-115

Our low-cost compact solution

new

Millikan's Apparatus

Compact apparatus for demonstrating the discrete nature (quantisation) of electric charge and for determining the elementary charge of an electron. Comprising an experiment chamber kit for assembly with plate capacitor and connected oil atomiser, lighting unit with two green LEDs, measuring microscope, voltage adjustment knob and switch to set the capacitor voltage, switch for starting and stopping rise and fall time measurements and a display unit with touch screen. Measurements can be made using the floating method or the rising and falling method. Measured rise and fall times for a charged droplet of oil are displayed on the touch screen along with the configured voltage. Parameters relevant to the evaluation of the results, temperature, viscosity and pressure are also displayed. Includes plug-in power supply, 12 VAC, 1 A.

Dimensions (including measuring microscope): 370x430x235 mm³
Weight (including plug-in power supply): 4.3 kg approx.

Contents:

- 1 Basic apparatus with experiment chamber and display unit
- 1 Measuring microscope
- 1 Oil atomiser
- 50 ml of oil for Millikan's apparatus
- 1 Plug-in power supply, 12 VAC, 1 A

Millikan's Apparatus (230 V, 50/60 Hz)

U20700-230

Millikan's Apparatus (115 V, 50/60 Hz)

U20700-115

Oil for Millikan's Apparatus

50 ml of oil for experiments using Millikan's apparatus.

U13109



U13109

Experiment Topics:

- Energy of a photon
- Mean emission wavelength for a light emitting diode
- Characteristic of an LED
- Cut-off voltage

Light Emitting Diodes for Determination of h

Mounting plate with six coloured light-emitting diodes with different emission wavelengths for determining Planck's constant h by measuring the cut-off voltage as a function of the frequency of the emitted light. Light-emitting diodes with series resistors mounted on a base plate with a stem. Contact can be made from the rear via safety connector plugs..

Wavelengths: 465 nm, 560 nm, 585 nm, 635 nm, 660 nm, 950 nm
 Series resistor: 100 Ω
 Max. voltage: 6 V
 Dimensions: 115x115 mm² approx.
 Weight: 120 g approx.

U8482460

Additionally required:

U33020-230 DC-Power Supply 0 – 20 V, 0 – 5 A (230 V, 50/60 Hz) or

U33020-115 DC-Power Supply 0 – 20 V, 0 – 5 A (115 V, 50/60 Hz)

U8557380 Analogue Multimeter, Escola 100

U8611210 Stand base

Experiment leads

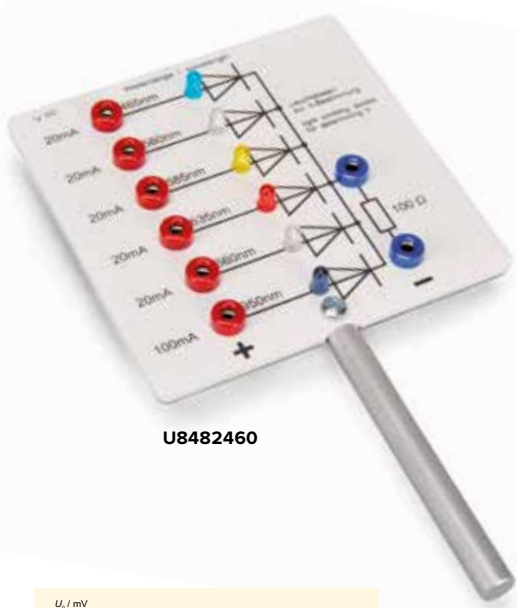

U8482460

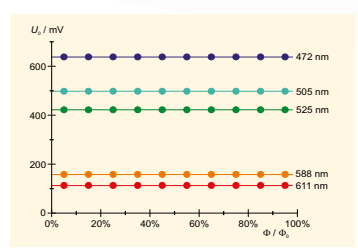

Cut-off voltage U_0 as a function of intensity (Planck's Constant Apparatus)

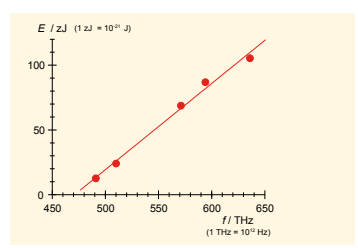

Graph of energy against frequency (Planck's Constant Apparatus)

Experiment Topics:

- Energy of a photon
- Mean emission wavelength for a light emitting diode
- Photocell
- Photo-electric effect and kinetic energy of electrons
- How electron energy depends on wavelength.
- How electron energy is independent of light intensity

Advantages

- Simple, safe and quick-to-operate compact device
- Accuracy < 5%
- Capable of demonstrating how electron energy is independent of light intensity

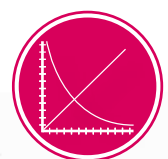

UE5010200
PDF online



U10700-230
U10700-115

Planck's Constant Apparatus

Simple, safe and quick-to-operate, compact apparatus with integrated photocell as well as a voltmeter and nano-ammeter for determining Planck's constant and the work done in emitting an electron using the stopping potential method. Five light emitting diodes (LEDs) of known mean wavelengths act as light sources of differing frequencies. The intensity of the light emitted by them can be varied from 0 to 100%.

Wavelengths: 472 nm, 505 nm, 525 nm, 588 nm, 611 nm
 Dimensions: 280x150x130 mm³
 Weight: 1.3 kg approx.

Contents:

- 1 Basic apparatus with photocell, voltmeter, nano-ammeter and power supply for light sources
- 5 LEDs in casings with connector leads
- 1 Plug-in power supply 12 V AC

Planck's Constant Apparatus (230 V, 50/60 Hz)

U10700-230

Planck's Constant Apparatus (115 V, 50/60 Hz)

U10700-115

U8482415



U8482445



Vacuum Photocell

Evacuated photocell for demonstrating the photoelectric effect and showing that the emission of electrons increases with increasing light intensity. Mounted ready for use on a base plate with electrical wiring and clamping bar.

Cathode:	Caesium on oxidised silver
Cathode area:	2.4 cm ²
Operating voltage:	50 V, max. 200 V
Working resistance:	1 MΩ
Dark current:	<0.05 μA
Sensitivity:	20 μA/lumen
Photoelectric current density:	max. 3.0 μA/cm ²

U8482415

Gas Filled Photocell

Gas-filled photocell for demonstrating the photoelectric effect with simple measuring instruments for use by students that also shows how the emission of electrons increases with increasing light intensity. Mounted ready for use on a base plate with electrical wiring and clamping bar.

Cathode:	Caesium on oxidised silver
Cathode area:	2.4 cm ²
Operating voltage:	50 V, max. 90 V
Working resistance:	1 MΩ
Dark current:	<0.1 μA
Sensitivity:	125 μA/Lumen
Photoelectric current density:	max. 0.7 μA/cm ²

U8482445

External Photoelectric Effect (Hallwachs Effect):

Equipment:

- U8473155 High-Pressure Mercury Vapour Lamp**
- U8531420 Electrometer Accessories**
- U13270 Tripod Stand, 150 mm**
- U15001 Stainless Steel Rod, 250 mm**
- U13255 Universal Clamp**
- U17450 Analogue Multimeter AM50**
- U21905-230 Control Unit for Spectrum Lamps (230 V, 50/60 Hz)**
- U8521400-230 DC Power Supply 450 V (230 V, 50/60 Hz)**
- U8531408-230 Electrometer (230 V, 50/60 Hz)**
- or
- U21905-115 Control Unit for Spectrum Lamps (115 V, 50/60 Hz)**
- U8521400-115 DC Power Supply 450 V (115 V, 50/60 Hz)**
- U8531408-115 Electrometer (115 V, 50/60 Hz)**

High-Pressure Mercury Vapour Lamp

High-pressure mercury vapour lamp in hardened glass bulb made of blackened borosilicate glass, with tube-shaped hole allowing emission of unfiltered ultra-violet radiation. Includes E27 lamp holder on stem and see-through screen to protect users from UV radiation.

Wavelength ranges:	UV-A, UV-B, UV-C
Power consumption:	125 W

U8473155

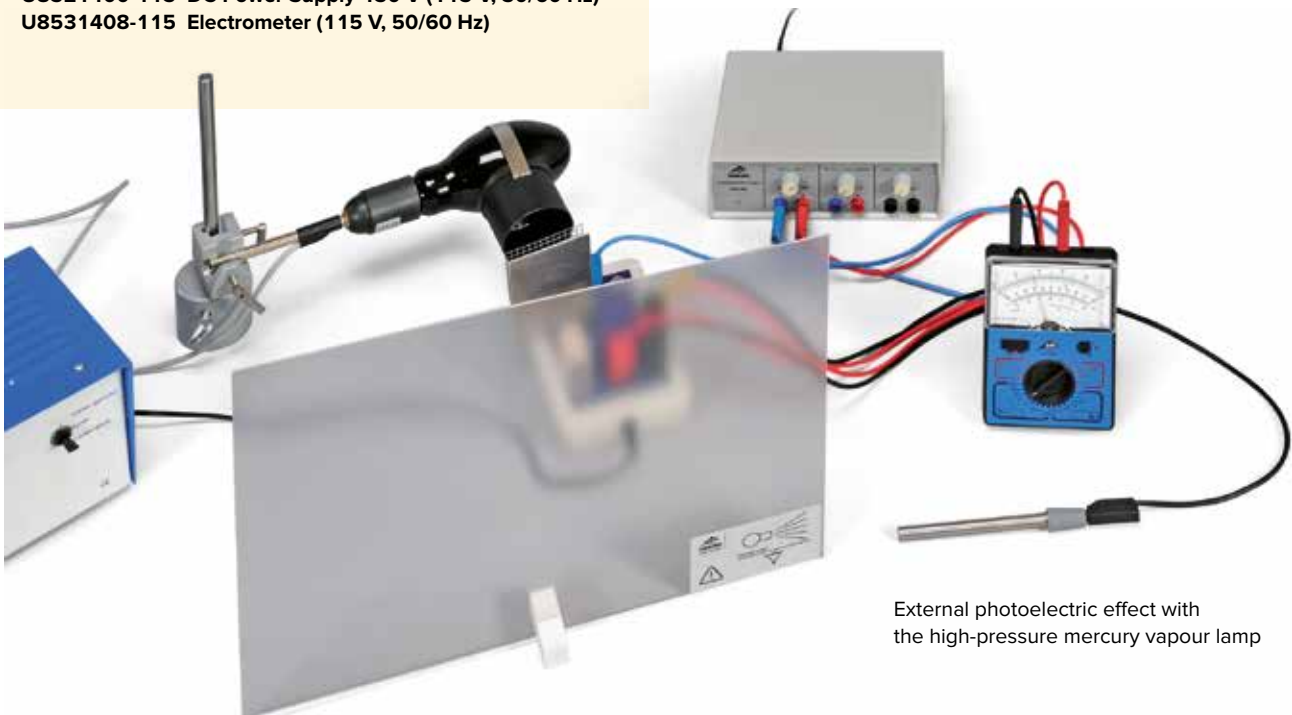

External photoelectric effect with the high-pressure mercury vapour lamp

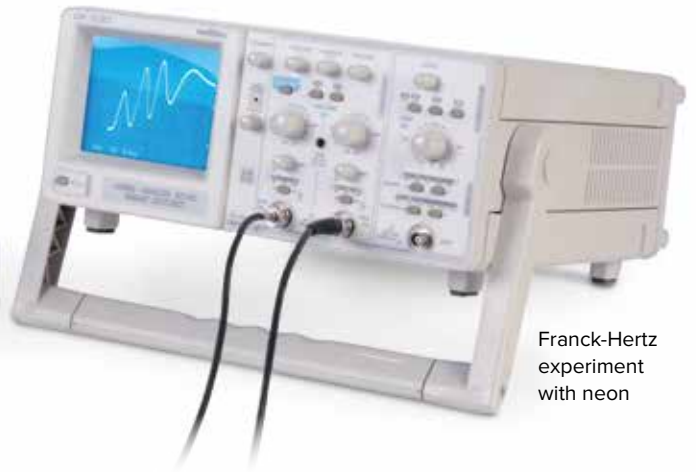
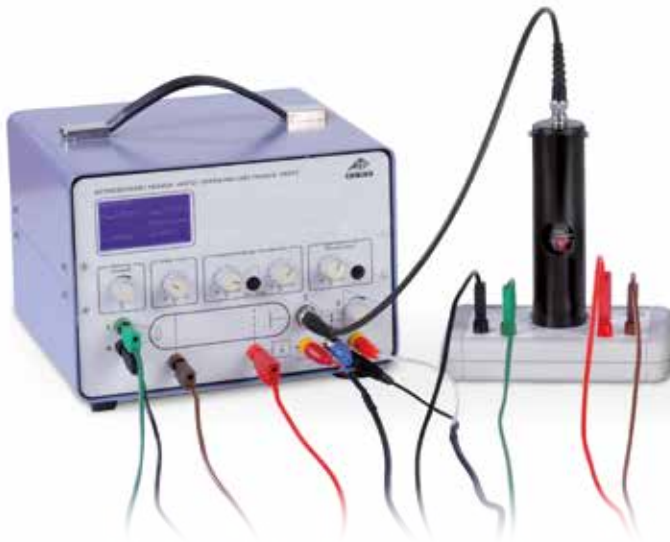

Franck-Hertz experiment with neon

Franck-Hertz Experiment

The quantization of energy and the generation, recording and evaluation of spectra, along with the experimental verification thereof, is included in most of the curricula used around the world. The well known experiment first performed by James Franck and Gustav Hertz in 1913 is critically important in terms of demonstrating discrete energy states in atoms.



U8482530-230
U8482530-115

Power Supply Unit for Franck-Hertz Experiment

Power supply unit for operating the mercury filled Franck-Hertz tube (U8482550-230 resp. U8482550-115), the neon filled Franck-Hertz tube (U8482230) or the critical potential tubes (U18560 and U18565). The equipment provides all the voltages needed to power the tubes and includes a sensitive built-in DC amplifier for measuring collector current. The voltages can simultaneously be read off a display. The accelerating voltage can be set-up manually on the apparatus or set to a saw-tooth wave form. Additional measuring inputs are also available for the anode current and accelerating voltage.

- Filament voltage U_F : 4 – 12 V, continuously adjustable
- Control voltage U_G : 0 – 12 V, continuously adjustable
- Accelerating voltage U_A : 0 – 80 V
- Modes of operation: manually adjusted / saw-tooth
- Countervoltage U_E : 0 – ± 12 V, continuously adjustable, switchable polarity

- Output U_E for collector current I_E : $I_E = U_A \cdot 38 \text{ nA/V}$ (0 – 12 V)
- Output U_Y for accelerating voltage U_A : $U_X = U_A / 10$
- Outputs: 4 mm safety sockets
- Input: BNC socket
- Dimensions: 160x132x210 mm³ approx.
- Weight: 3.4 kg approx.

Power Supply Unit for Franck-Hertz Experiment (230 V, 50/60 Hz)

U8482530-230

Power Supply Unit for Franck-Hertz Experiment (115 V, 50/60 Hz)

U8482530-115



UE5020400
PDF online

Franck-Hertz experiment with mercury

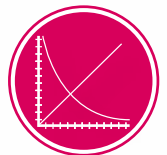

UE5020300
PDF online



Franck-Hertz Tube with Neon Filling on Base

Highly evacuated electron tube containing neon, mounted on a base with socket connection for demonstrating that free electrons colliding with neon atoms emit energy in quantized packets and for determining the excitation energy of the 3P_0 or 3S_1 states at about 19 eV. When excited, these states emit visible light due to the energy drop from intermediate levels to a ground state at an excitation energy of about 16.7 eV. The light so emitted is in the red-yellow region of the spectrum. Parallel bands of light are formed between the control grid and the accelerator grid and can be observed through a window. The Franck-Hertz neon tube can be operated at room temperature. Tetraode with indirectly heated cathode, mesh control grid, mesh accelerating grid and collector (counter) electrode. Mounted on a base with colour coded connection sockets.

Filament voltage:	4 – 12 V
Control voltage:	9 V
Accelerating voltage:	max. 80 V
Counter voltage:	1.2 – 10 V
Tube:	130 mm x 26 mm diam. approx
Base with connector sockets:	190x115x115 mm ³ approx.
Weight:	450 g approx.

U8482230

Additionally required:

U8482530-230 Power Supply Unit for Franck-Hertz Experiment (230 V, 50/60 Hz)

or

U8482530-115 Power Supply Unit for Franck-Hertz Experiment (115 V, 50/60 Hz)

U11175 Analogue Oscilloscope 2x30 MHz



U8482230



Replacement Tubes for Franck-Hertz Experiment

Franck-Hertz Tube with Hg

U8482170

Franck-Hertz Tube with Ne

U8482240



U8482240



U8482170

Franck-Hertz Tube with Mercury Filling and Heating Chamber

Highly evacuated electron tube containing mercury in a heating chamber for demonstrating the discrete nature (quantization) of the energy released by free electrons in collisions with mercury atoms, and for determining the excitation energy of the mercury resonance line ($6^1S_0 - 6^3P_1$), which is 4.9 eV. The electron tube must be heated in the chamber to generate the necessary mercury vapour pressure to achieve a sufficiently high probability of collisions between electrons and mercury atoms. Electron tube with a plane parallel electrode system consisting of an indirectly heated oxide cathode with aperture, a grid and a collecting electrode. Front plate with printed tube symbol visible from a distance. Electric heating chamber with continuous temperature control and digital temperature display showing actual and set-point temperatures. In lacquered metal housing with two observation windows, opening with spring clip for thermometer, and thermally insulated carrying handle. Temperature measurement and control is handled by an integrated microcontroller and a Pt100 thermocouple.

Heater voltage:	4 – 12 V
Grid voltage:	0 – 70 V
Suppressor voltage:	1.5 V approx.
Tube dimensions:	130 mm x 26 mm diam. approx.
Heater output:	400 W
Temperature range:	160° C – 240° C
Temperature constancy:	±1° C approx.
Overall dimensions:	335x180x165 mm ³ approx.
Weight:	5.6 kg approx.

Franck-Hertz Tube with Mercury Filling and Heating Chamber (230 V, 50/60 Hz)

U8482550-230

Franck-Hertz Tube with Mercury Filling and Heating Chamber (115 V, 50/60 Hz)

U8482550-115

Additionally required:

U8482530-230 Power Supply Unit for Franck-Hertz Experiment (230 V, 50/60 Hz)

or

U8482530-115 Power Supply Unit for Franck-Hertz Experiment (115 V, 50/60 Hz)

U11175 Analogue Oscilloscope 2x30 MHz



U8482550-230
U8482550-115

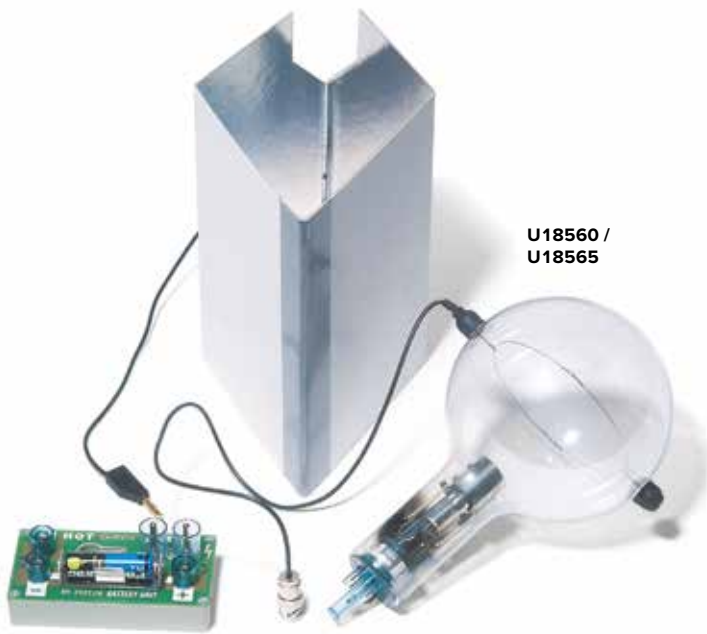

U18560 /
U18565

U186501-230
U186501-115



Gustav Hertz Experiment:

Gustav Hertz' experiment is a development of the Frack-Hertz experiment. Atoms are excited or even ionised by means of inelastic collisions with electrons inside an evacuated tube. If the kinetic energy of the electrons exactly matches a critical potential or ionisation level, the electrons transfer all their energy to the atoms and can then be drawn away to the collector ring in the tube with the help of a small voltage. At this point, the collector voltage reaches a maximum.

Critical Potentials Tube S

Hertz electron tube for quantitative investigations of inelastic collisions of electrons with inert gas atoms, determination of ionization energy of helium resp. neon, as well as resolution of the energy states of various primary and orbital angular-momentum quantum numbers. Includes shielding and battery unit for the collector voltage (battery not included).

Cathode filament

- voltage: $U_F \leq 7 \text{ V}$
- Anode voltage: $U_A \leq 60 \text{ V}$
- Anode current: $I_A \leq 10 \text{ mA}$
- Collector voltage: $U_C = 1.5 \text{ V}$
- Collector current: $I_C \leq 200 \text{ pA}$

Critical Potentials Tube S with He Filling

Critical potentials of helium:

- 2 ³S: 19,8 eV
- 2 ¹S: 20,6 eV
- 2 ³P: 21,0 eV
- 2 ¹P: 21,2 eV
- 3 ³S: 22,7 eV
- 3 ¹S: 22,9 eV
- 3 ³P: 23,0 eV
- 3 ¹P: 23,1 eV
- 4 ³S: 23,6 eV
- 4 ¹S: 23,7 eV
- Ionisation: 24,6 eV

U18560

Critical Potentials Tube S with Ne Filling

Critical potentials of neon:

- 2p⁵3s¹: 16,6 eV
- 2p⁵3p¹: 18,4 eV
- 2p⁵4s¹: 19,7 eV
- 2p⁵4p¹: 20,3 eV
- 2p⁵4d¹: 20,6 eV
- Ionisation: 21,6 eV

U18565

Control Unit for Critical Potentials Tubes

Control unit for operating the critical potentials tubes. Equipped with an output for sawtooth acceleration voltages; adjustable upper and lower limits of the acceleration voltage. Integrated pico-ammeter amplifier for anode current measurement. Allows recording of the acceleration voltage as a function of the anode current. A slow sawtooth voltage (approx. 6 seconds per cycle) is available with an interface or XY-recorder; a sawtooth voltage with a repetition rate of 20 Hz is available for oscilloscopic observations. Includes plug-in power supply.

Input:

Anode current measurement via a BNC jack

Outputs:

- Tube: Sawtooth acceleration voltage of 0 – 60 V, 20 Hz
- Fast: Voltage signal of 0 – 1 V, proportional to the acceleration voltage, for oscilloscopic observations
- Slow: Voltage signal of 0 – 1 V proportional to the acceleration voltage, for recording data with an XY-recorder or interface
- Anode current: Voltage signal of 0 – 1 V proportional to the anode current (1 V/nA)
- Supply voltage: 12 V AC
- Dimensions: approx. 170x105x45 mm³

Control Unit for Critical Potentials Tubes (230 V, 50/60 Hz)

U186501-230

Control Unit for Critical Potentials Tubes (115 V, 50/60 Hz)

U186501-115

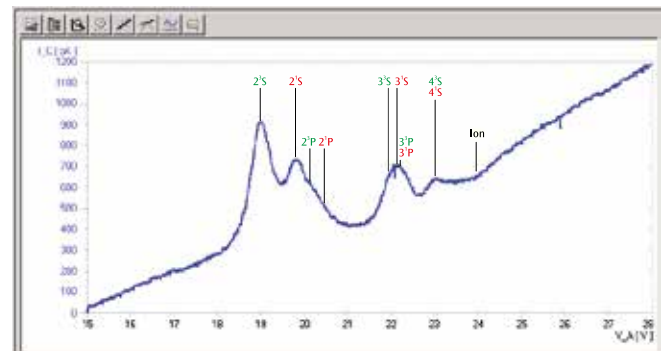

Collector current I_R as a function of accelerating voltage U_A . Gas filling: He.

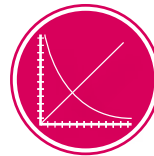

UE5020500
PDF online



Experiment set-up with the control unit for critical potentials tubes

Experiment set-up with the control unit for critical potentials tubes

- Additionally required:
- U185002 Tube Holder S**
 - U186501-230 Control Unit for Critical Potentials Tubes (230 V, 50/60 Hz)**
 - U33020-230 DC-Power Supply 0 – 20 V, 0 – 5 A (230 V, 50/60 Hz)**
- or
- U186501-115 Control Unit for Critical Potentials Tubes (115 V, 50/60 Hz)**
 - U33020-115 DC-Power Supply 0 – 20 V, 0 – 5 A (115 V, 50/60 Hz)**

- Additionally recommended:
- U118091 Digital-Multimeter P3340**
 - U112491 USB Oscilloscope 2 x 50 MHz**
 - U11257 HF Patch Cord, BNC/4 mm Plug (2x)**
 - U138021 Set of 15 Safety Experiment Leads 75 cm**

Experiment set-up with the control unit for the Franck-Hertz experiment

- Additionally required:
- U185002 Tube Holder S**
 - U8482530-230 Control Unit for the Franck-Hertz Experiment (230 V, 50/60 Hz)**
- or
- U8482530-115 Control Unit for the Franck-Hertz Experiment (115 V, 50/60 Hz)**

- Additionally recommended:
- U112491 USB Oscilloscope 2 x 50 MHz**
 - U11257 HF Patch Cord, BNC/4 mm Plug (2x)**
 - U138021 Set of 15 Safety Experiment Leads 75 cm**



Experiment set-up with the control unit for the Franck-Hertz experiment



Experiment set-up for transmissive illumination of sodium fluorescence tube with a beam of white light

Experiment Topics:

- Sodium resonance fluorescence
- Absorption of Na spectral lines in a sodium mist

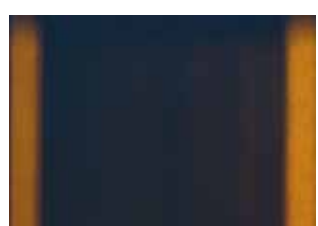

Absorption of white light (left) and yellow sodium light (right) in a glass tube containing sodium vapour. In each case, the light is dispersed far enough for it to pass unobstructed to the left and right of the tube.

Sodium Fluorescence Tube on Furnace Wall

Highly evacuated glass tube containing multiply distilled sodium for demonstrating the resonance fluorescence of sodium vapour. Filled with argon. The tube is heated in the furnace up to temperatures of between 180°C and 200°C in order to achieve sufficient pressure of sodium vapour. The entire tube emits yellow light at the wavelength of the sodium D line when it is brought to the heated state and illuminated with sodium spectral light. The sharply defined sodium D line appears in the spectrum. If it is instead illuminated with white incandescent filament light, the transmitted light exhibits a dark absorption line at the position of the sodium D line. Absorption can be demonstrated even without the use of a spectrometer due to the clear shadow formed when yellow sodium light passes through the tube.

Dimensions of tube: 170 mm x 42 mm diam.

Dimensions of hotplate: 230x160 mm² approx.

Weight: 550 g approx.

U8482260.....

Additionally required:

U8482590-230 Heating Chamber (230 V, 50/60 Hz)

or

U8482590-115 Heating Chamber (115 V, 50/60 Hz)

Additionally recommended:

U8476840 Sodium Vapour Spectrum Lamp

U21905-230 Choke for Spectrum Lamps (230 V, 50/60 Hz)

or

U21905-115 Choke for Spectrum Lamps (115 V, 50/60 Hz)

U21881 Optical Lamp, Halogen

U13900-230 Transformer 12 V, 60 VA (230 V, 50/60 Hz)

or

U13900-115 Transformer 12 V, 60 VA (115 V, 50/60 Hz)

U13270 Tripod Stand, 150 mm

U17101 Convex lens on stem, 50 mm

U8611200 Barrel Foot, 0.9 kg

U8472660 Hand Held Spectroscope with Amici Prism

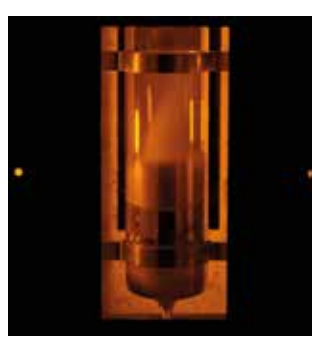

Observation of sodium vapour in yellow sodium light

U8482590-230
U8482590-115



Heating Chamber

Electric heating chamber with continuous temperature control and digital temperature display showing actual and set-point temperatures. In lacquered metal housing with two viewing windows, opening with spring-clip for thermometer and thermally insulated carrying handle. Temperature measurement and control is handled by an integrated microcontroller and a Pt100 thermocouple.

Dimensions of front opening: 230x160 mm² approx.

Heating power: 400 W

Maximum temperature: 300°C (230 V, 50/60 Hz)

250°C (115 V, 50/60 Hz)

Temperature constancy: ±1°C approx.

Dimensions: 335x180x165 mm³ approx.

Weight: 5.6 kg approx.

Heating chamber (230 V, 50/60 Hz)

U8482590-230.....

Heating chamber (115 V, 50/60 Hz)

U8482590-115.....

Experiment Topics:

- **Properties of X-rays:**
 - Transmission
 - Linear propagation
 - Ionisation
 - X-ray photography
- **Fluorescent radiation**
- **Shielding of X-rays**
- **Absorption experiments**
- **Distance law**
- **Dosimetry and radiation protection**
- **Diffraction of X-rays:**
 - Laue's recordings
 - Debye-Scherrer's recordings
 - Bragg's reflection
 - Duane-Hunt's displacement law (h-determination)
- **Moseley's law**



U192001
U192001-US

X-Ray Apparatus

The experiment chamber is contained in a closed, radiation-proof housing with a transparent synthetic-glass shield. If the synthetic-glass shield is opened, the high-voltage source for the X-ray tube is deactivated automatically. The high-vacuum X-ray tube with a directly heated tungsten cathode and copper anode is positioned in a borosilicate glass chamber with a thin-walled, concave ray emission window. A lead-glass hood with a collimator causes X-rays to emerge in parallel with the experiment plane and provides a shield against scattered radiation. The horizontal counter-tube goniometer consists of a central sample holder and a swiveling arm. In the form of a slide tray, this arm serves as a mount for the Geiger-Müller tube (U19201), Ionisation chamber (U19208) as well as experimental devices in slide format or on a 5x5 cm base plate (for example, from U19205, U19206, U19207). The swiveling arm can be rotated manually independently of the sample holder, or at a fixed mutual angle with a ratio of 2:1, for instance, for experiments involving Bragg's reflection. The device is equipped with angle and millimeter scales, position markings for experimental devices, as well as radiation-proof bushings for cables and hoses. Including one cable to measure the tube current.

Anode voltage:	20/30 kV, switchable and electronically stabilised
Emission current:	0 to 80 μ A, continuously adjustable and electronically stabilised
Cathode heating:	4 V, 1 A
Focal spot:	5x1 mm ²
Anode material:	Cu
Lead-glass collimator:	radiation emission aperture with 5 mm diam.
Ray divergence:	better than 10°
Characteristic radiation wavelength:	Cu-K _{α} : 154 pm, Cu-K _{β} : 138 pm
Cable to measure tube current:	approx. 50 cm, 2.5 mm jack / 4 mm plugs (red / black)

Counter-tube goniometer:

Swiveling ranges:	0°, +10° to +130° and -10° to +130° relative to the ray axis
Angular coupling:	independent of the sample holder or with a ratio of 2:1
Measurement accuracy of Bragg's angle:	5 arc minutes
Timer:	0 to 55 minutes, continuously adjustable
Power consumption:	100 VA

Dimensions:

X-ray apparatus:	approx. 250 mm x 370 mm diam.
X-ray tube:	approx. 100 mm x 32 mm diam.
Weight:	approx. 9 kg

X-Ray Apparatus (230 V, 50/60 Hz)

U192001

X-Ray Apparatus (115 V, 50/60 Hz)

U192001-US

Spare Tube for X-Ray Apparatus (not shown)

Spare tube with Cu anode for X-ray apparatus (U192001) and X-ray apparatus (U192001-US).

U19204

Motor Drive Debye-Scherrer (230 V, 50/60 Hz)

For structural investigations using the rotating-crystal method, suitable for the Debye-Scherrer camera (contained in U19205). Power transmission via bevel gears.

Power consumption: 3 VA

U192021-230



Recommended for operation at a mains supply voltage of 100 – 120 V (not shown):

Voltage Transformer 120 V / 230 V

W10851

U192021-230

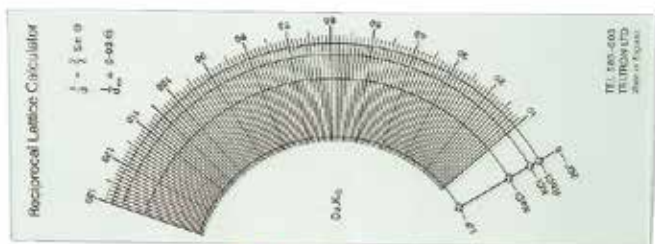

U19206



Crystallography Accessories

These accessories for the basic equipment set (U19205) are intended for additional crystallographic experiments as well as treatments of Moseley's law, the Debye-Scherrer method, Bragg's reflection and material tests.

Contents:

- 4 foils, Fe, V, Mn, Cr
- 2 single crystals, KCl, RbCl
- 5 powder samples, NaF, SiC, NH₄Cl, MgO, Al
- 2 wire samples, Al, Nb (3x each) for Debye-Scherrer experiments
- 10 polyethylene threads
- 1 disc for calculating Bragg's angle

U19206

Radiography Accessories

These accessories for the basic equipment set (U19205) are intended for investigating the following topics: scattering, absorption; dependence on acceleration voltage, emission current and penetration power, resolving power; shielding, half width; exposure time, non destructive materials testing.

Contents:

- 1 Maltese cross
- 1 phantom
- 1 pin diaphragm
- 1 aluminium layer, stepped
- 5 aluminium absorbers, 0.1/0.25/0.5/1.0/2.0 mm
- 1 lead absorber, 0.5 mm
- 1 plastic absorber
- 2 magnets
- 4 materials testing models (porosity, fissures, welding seam, painting)

U19207



U19207

Geiger-Müller Tube T

Self-extinguishing halogen-trigger counter tube for registering alpha, beta, gamma and X-radiation. Enclosed in a plastic housing with a holder for mounting on the swiveling arm of the X-ray apparatus (U192001 or U192001-US); equipped with a firmly installed BNC patch cord. Includes a retention clip for other types of mounting. Dose-rate range: $10^{-3} - 10^2$ mGy/h
 Mass of the active surface: Mica: 2.0 – 3.0 mg/cm²
 Operating voltage: 500 V
 Dimensions: approx. 50 mm x 50 mm x 22 mm diam.
 Cable length: approx. 1 m

U19201

Basic Set Bragg

Basic equipment set for Bragg's reflection experiment with a LiF and a NaCl crystal.

Contents:

- 1 slit diaphragm collimator, 1 mm
- 2 slit diaphragms, 1 mm/3 mm
- 2 single crystals, LiF, NaCl
- 1 Geiger Müller tube (U19201)

U19212



U19212

U19201

Basic Equipment Set

Equipment set for qualitative and quantitative experiments involving, for instance, linear propagation and quantitative experiments involving, for instance, linear propagation, ionisation, penetration capacity of X-radiation and X-ray photography; also for demonstrating the wave nature of X-radiation, investigating fluorescent X-radiation and determining mass-absorption coefficients. In a specially moulded storage box.

U19205

Contents:

- 1 fluorescent screen
- 1 Debye-Scherrer camera
- 2 film cassettes
- 1 lead mask
- 2 plate electrodes on a 4 mm contact pin
- 1 slit diaphragm collimator, 1 mm
- 1 pin diaphragm collimator, 1 mm diam.
- 1 ancillary magazine with a circular aperture
- 2 slit diaphragms, 1 mm/3 mm
- 1 pin diaphragm, 9.5 mm diam.
- 2 single crystals, LiF, NaCl
- 2 mini crystals, LiF
- 1 powder sample, LiF
- 10 copper wires
- 4 absorption foils, Ni, Cu, Co, Zn
- 1 scattering-foil revolver, coated with V, Cr, Mn, Fe, Co, Ni, Cu, Zn
- 1 set of assembly aids (acetate adhesive, clips)
- 1 storage box, specially moulded



U19205



U40207

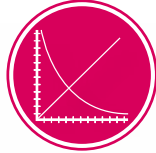

UE7010100
PDF online

Bragg Driver

The Bragg driver is a combination of hardware and software which allows the user to collect X-ray diffraction data in combination with the X-ray apparatus (U192001 or U192001-US). It provides the high voltage and counting circuitry for the Geiger Müller tube (U19201) and includes a software program that allows the user to control the driver and collect data. It includes the USB powered drive, a drive gear, an USB cable and a powder compressor. Scans can be obtained for all crystals available in the basic equipment set (U19205) and the crystallography accessories (U19206). An additional feature includes the ability to scan powders and foils. The software allows selection of scan angles, resolution, and time per step. Once the experiment is completed the software permits zoom-in on the data and the facility to add comments to the file. Data can be exported to a spreadsheet for further analysis.

- Time interval for automatic data saving: 30 s
- Angular range: 12° – 120°
- Time per step: ≥ 0.1 s
- Angular step: ≥ 0.05°
- GM tube voltage: 0 – 1000 V

U40207



Recommended equipment:

Art. No.		Basic	Intermediate	Advanced
U192001 or U192001-US	X-ray Apparatus	yes	yes	yes
U19201	Geiger Müller Tube T	yes	yes	yes
U40207	Bragg Driver	yes	yes	yes
U19205	Basic Equipment Set	yes	yes	yes
U19206	Crystallography Accessories		yes	yes
U19207	Radiography Accessories			yes
U192021-230	Motor Drive		yes	yes
U19209	Filmpack2	yes	yes	yes
U19210	Filmpack 4	yes	yes	yes

X-Ray Apparatus

Basic:

Basic experiments using photographic techniques and Geiger Müller tube like Laue experiments, Bragg diffraction experiments, experiments on inverse square law, emission, rectilinear propagation, penetration and absorption of X-rays.

Intermediate:

Basic experiments and experiments on Moseley, Debye-Scherrer diffraction, size of the unit cell in salt crystals in addition.

Advanced:

Intermediate experiments and experimental investigations into radiography, film and the properties of x-rays in addition.

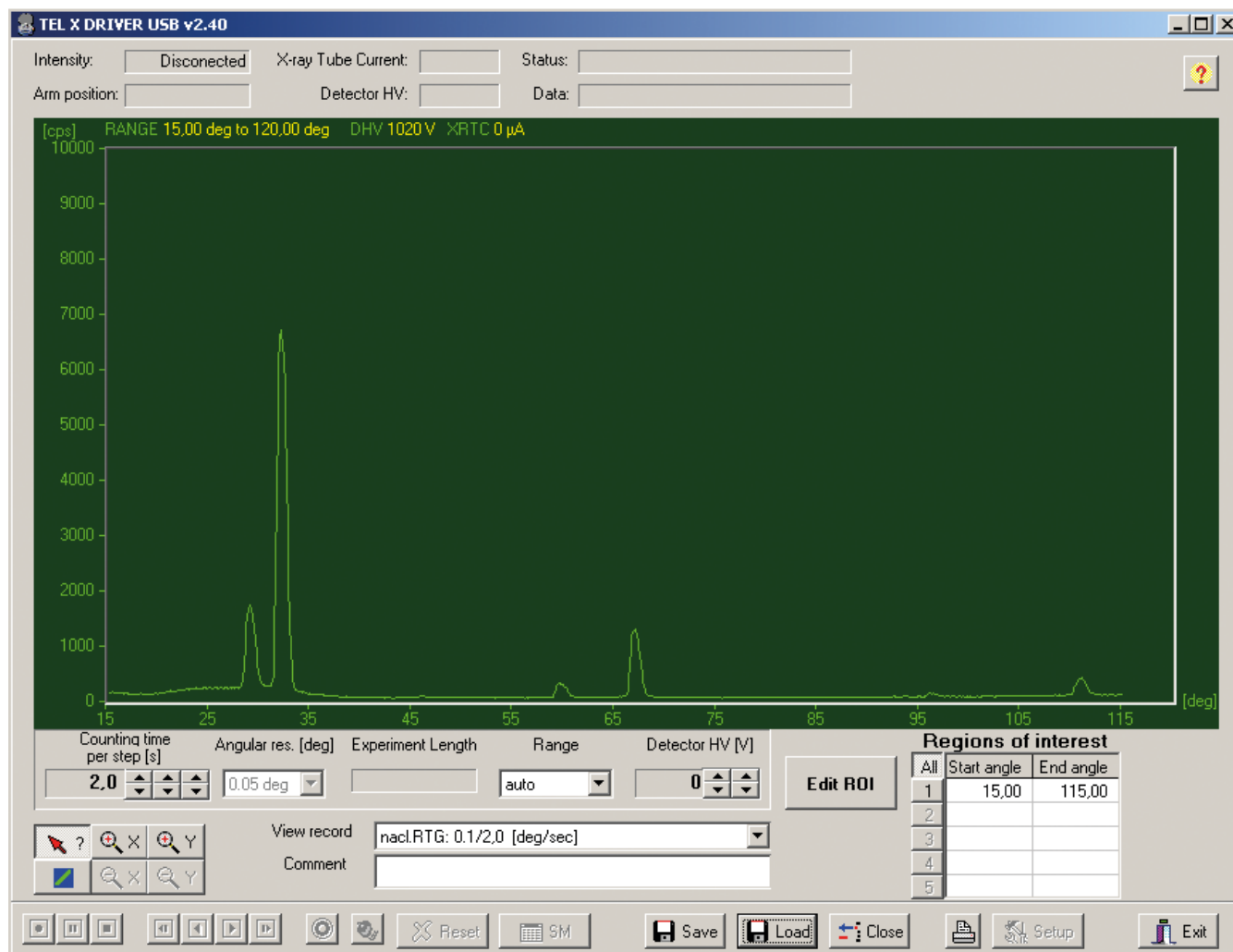

Bragg curve for LiF

Atomic and Nuclear Physics

X-ray Energy Detector

X-ray detector for recording energy spectra of X-rays or γ radiation in the energy range of approx. 2 keV to 60 keV. It mainly consists of a Si-PIN photodiode which is integrated in a metal housing together with a charge sensitive preamplifier, a main amplifier with pulse shaping and a digital signal processing circuit. The detector holder is particularly designed for installation on the swiveling arm of the X-ray apparatus (U192001 or U192001-US). The power supply is ensured via the USB port of a PC. Including CD with measuring and evaluation software for PC.

Energy range:	approx. 2 keV up to 60 keV
Energy resolution (FWHM):	0.55 keV at $E_{FeK\alpha} = 6.40$ keV
Entrance window:	Plastics (absorption equivalent to Graphite with $d = 40 \mu\text{m}$)
Detector:	Si-PIN photo diode
Active Area:	0.8 mm diam.
Thickness:	approx. 200 μm
Dead time per pulse:	approx. 200 μs
Connection:	USB
Cable length:	1.75 m
Dimensions:	80 mm x 22 mm diam.
Mass:	150 g

U10600

Additionally required:

U192001 X-Ray Apparatus (230 V, 50/60 Hz)

or

U192001-US X-Ray Apparatus (115 V, 50/60 Hz)

Additionally recommended:

U40206 Set of Fluorescence Samples

Experiment Topics:

- X-ray energy spectroscopy
- Compton effect
- X-ray fluorescence spectroscopy
- Absorption experiments
- Bragg's reflection
- Duane-Hunt's displacement law
- Moseley's law

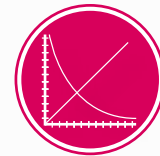

UE7020100
PDF online

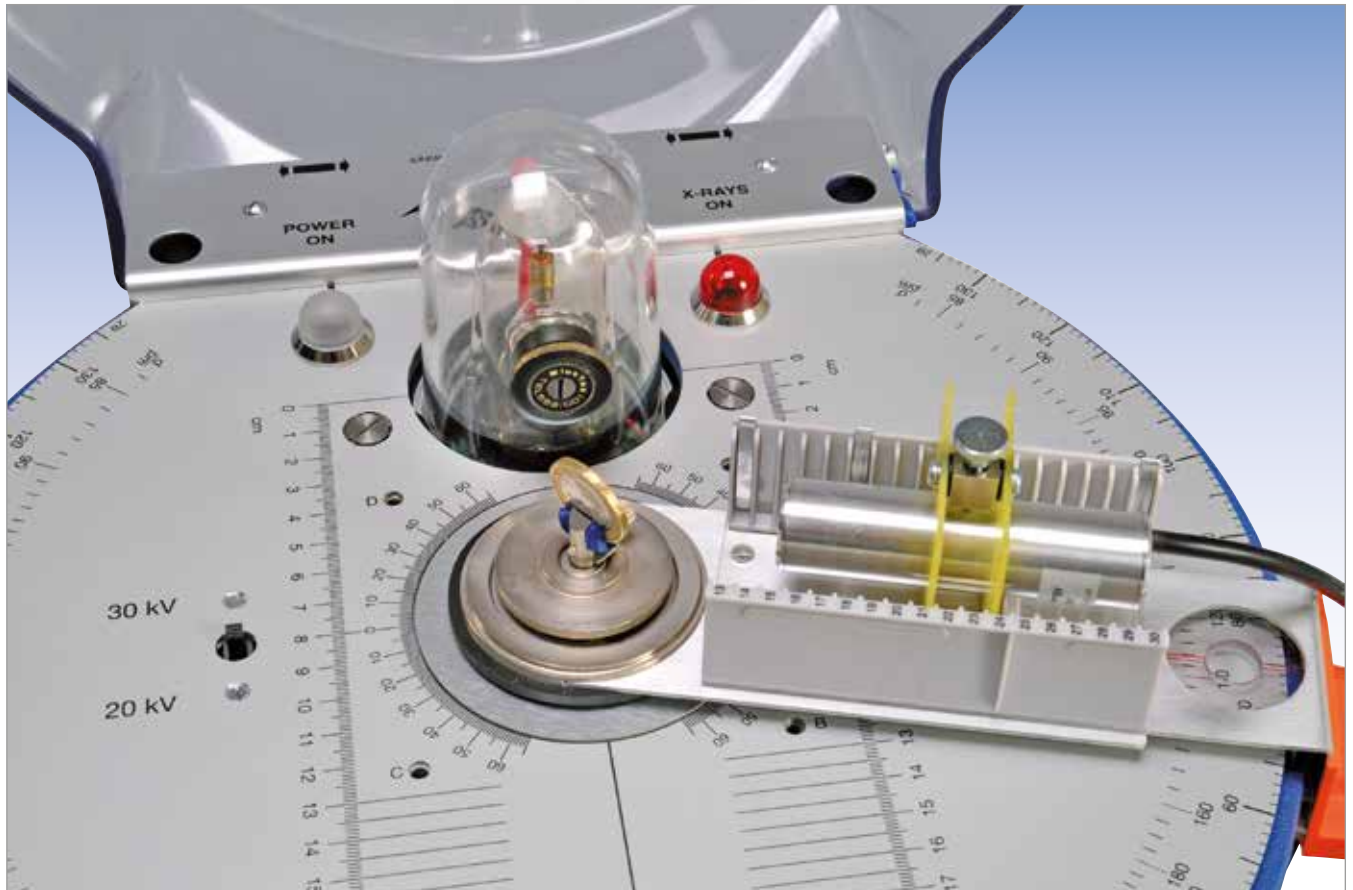

Simplified energy band diagram for an atom with characteristic X-ray lines

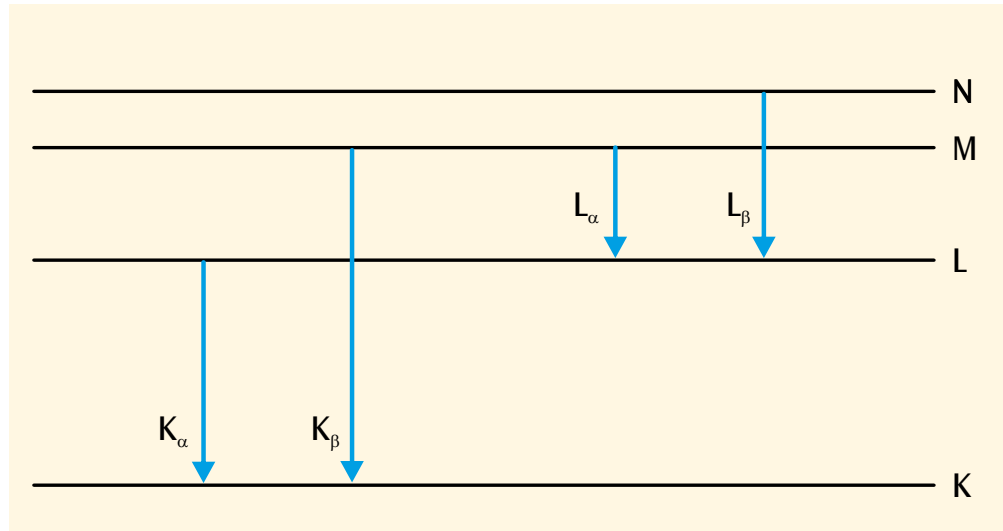

X-Ray Apparatus

X-ray fluorescence spectrum for a one euro coin

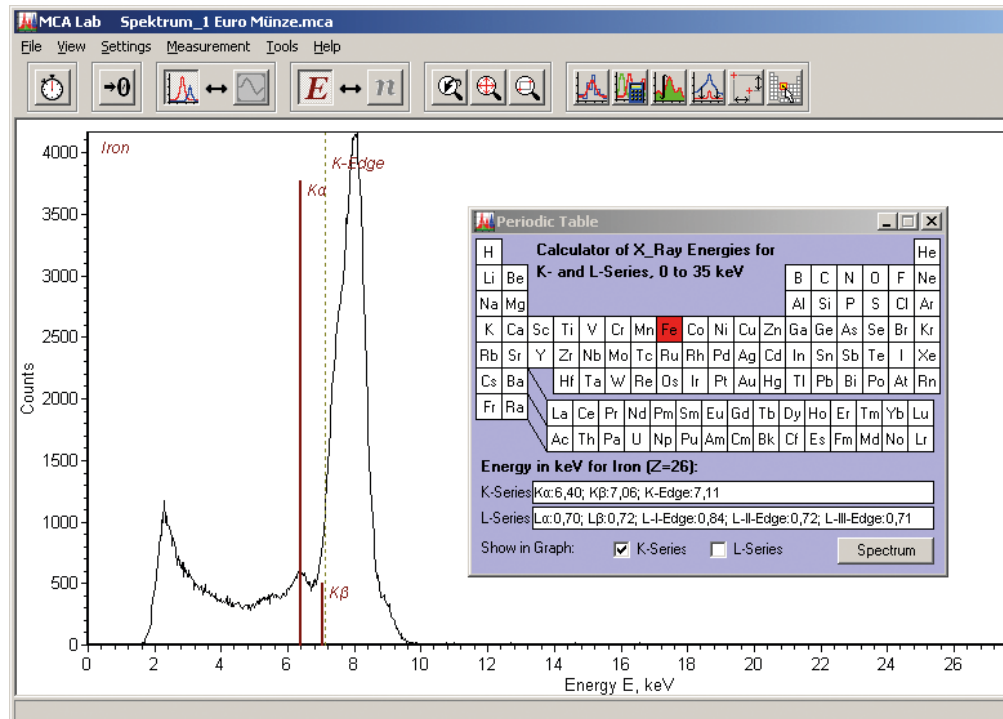

X-ray fluorescence spectra for wrought iron (red) and stainless steel (black)

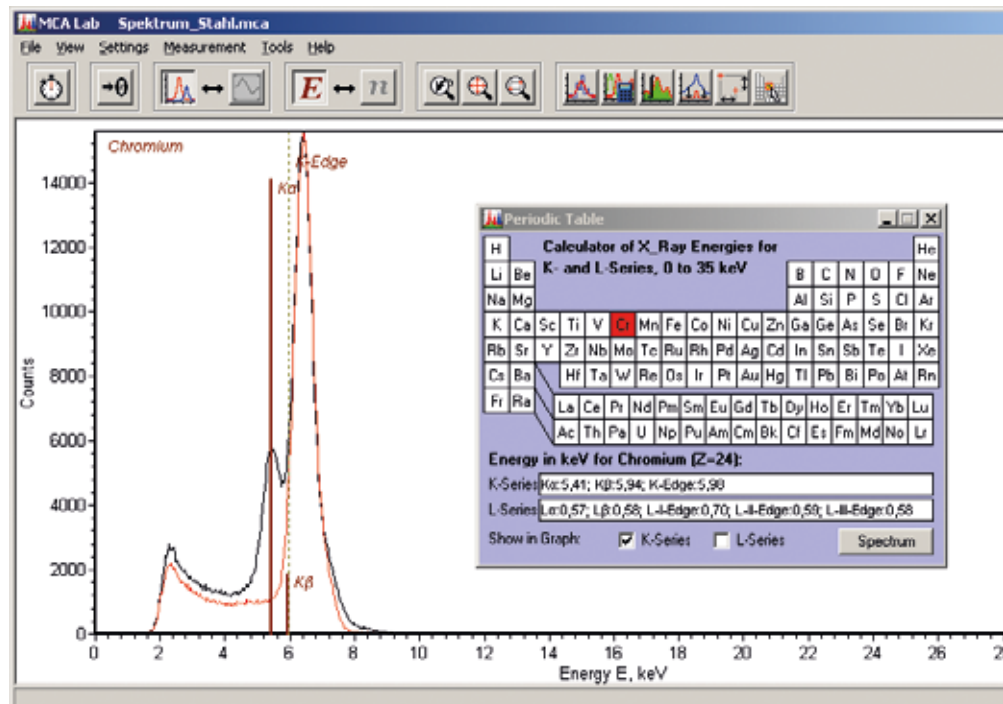

Atomic and Nuclear Physics

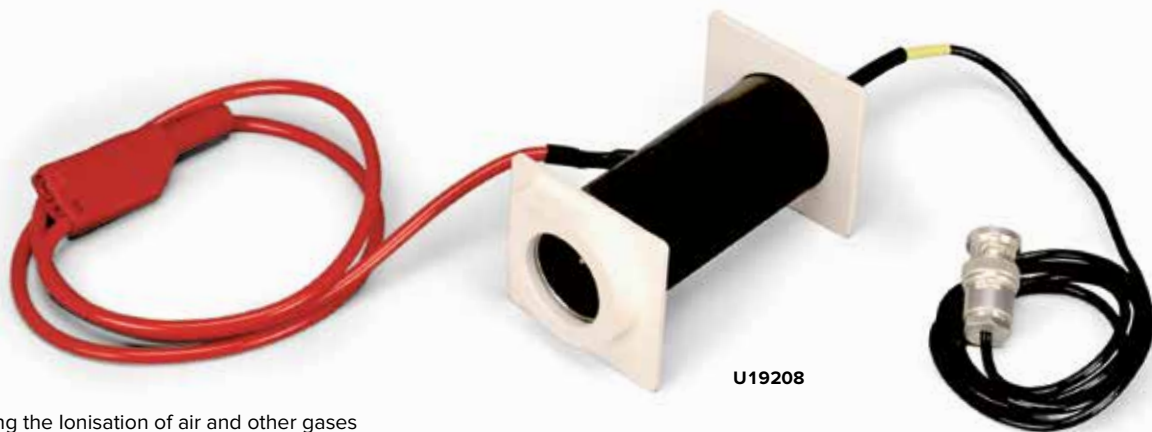

U19208

Ionisation Chamber

Intended for investigating the ionisation of air and other gases brought about by X-radiation at different pressures (saturation characteristics, model of a Geiger-Müller tube, dosimetry). Possesses a cylinder-shaped cathode, rod-anode and hose shaft for evacuating and introducing gases.

- Operating voltage: max. 2 kV
- Ionisation current: $10^{-11} - 10^{-10}$ A
- Rod-electrode: approx. 75 mm long
- Chamber: approx. 85 mm x 25 mm diam.
- Hose shaft: approx. 5 mm diam.

U19208

Additionally required:

- U33010-230 High Voltage Power Supply 5 kV (230 V, 50/60 Hz)** and **U8531408-230 Electrometer (230 V, 50/60 Hz)** or
- U33010-115 High Voltage Power Supply 5 kV (115 V, 50/60 Hz)** and **U8531408-115 Electrometer (115 V, 50/60 Hz)**
- U8531420 Electrometer Accessories**
- U17450 Analogue Multimeter AM50**
- U11260 Adaptor BNC/Jack 4-mm-Plugs**
- U13812 Pair Safety Experiment Leads, 75 mm**



Filmpack 2

Highly sensitive film (38x35 mm²) for α -, β - and X-radiation. Single packaging in opaque plastic cases allows development and fixing in daylight (duration: approx. 6 minutes).

Contents:

- 20 film sheets (38x35 mm²) in light-tight plastic cases
- 1 bottle of X-ray developer
- 1 bottle of X-ray fixer
- 1 syringe with a cannula for introducing chemicals into the film cases
- 1 metal clip

U19209

Set of Fluorescence Samples

Set of 7 samples for material analysis with the X-ray energy detector (U10600). The material composition can be determined from the energies of the appropriate X-ray fluorescence lines. Thus, for example the difference between stainless and low carbon steel, or between copper, brass and bronze can be seen clearly.

Materials:

Stainless Steel S321, Low Carbon Steel, Copper C101, Brass C260, Bronze C220, Zinc and Lead.

U40206



U40206

Filmpack 4

Like U19209, but consisting of 12 film sheets, 150x12 mm², in light-tight plastic cases for a Debye-Scherrer camera.

U19210



U19209

U19210

Geiger-Müller Counter Tube

Self-quenching halogen pulse ionisation chamber for detecting alpha, beta, gamma and x-ray radiation. In metal housing with mica window, removable mounting clamp with shaft. Long plateau length.

Filling:	Neon/argon mixture, halogen as quenching agent
Cathode dimensions:	approx. 39x14 mm ²
Window:	mica, 9 mm diam.
Mass per unit area:	1.5 – 2.0 mg/cm ²
Plateau length:	400 V – 600 V
Operating voltage:	400 – 600 V (recommended: 500 V)
Relative plateau slope:	0.04 %/V
Dead time:	90 µs
Limiting resistor:	10 MΩ, integrated in holder
Shaft:	approx. 100 mm x 10 mm diam.
Dimensions counter tube:	approx. 85 mm x 25 mm diam.
Weight:	approx. 160 g

U8533430

Additionally required:

- U11255 HF Patch Cord, 1 m**
 - U8533341-230 Digital Counter (230 V, 50/60 Hz)**
- or
- U8533341-115 Digital Counter (115 V, 50/60 Hz)**



U8533430

Digital Counter

Digital counter/timer for measuring duration of motion, transition times, periods, pendulum periods and frequencies, as well as for counting events or Geiger tube pulses. Includes a speaker that can be turned on and off, power supplies for direct connection to light barriers (U11365) or for powering a Geiger-Müller counter (U8533430). For event counting, a fixed counting period can be programmed in a range from 1 s to 99999 s. Counter events (start, stop) can either be triggered by a signal to the input sockets or manually via switches. Includes plug-in power supply.

Time measurement:	0.1 ms – 99999 s
Resolution:	0.1 ms / 1 ms / 0.1 s
Frequency measurement:	1 – 100 kHz, where voltage > 1.5 V _{pp}
Resolution:	1 mHz (1 – 100 Hz), 1 Hz (1 – 100 kHz)
Counting periods:	1/10/60/100 s or manually triggered
Input A:	miniDIN 8 socket, 4 mm safety sockets
Input B:	miniDIN 8 socket, 4 mm safety sockets
Input voltage A:	0.5 V – 15 V AC
Input voltage B:	1 V – 15 V AC
Active edge	Rising/falling
Counter tube input:	BNC socket
Power supply:	550 V / 1 MΩ
Display:	5-digit LED display
Operating voltage:	9 – 12 V DC via plug-in power supply
Dimensions:	250x100x160 mm ³ approx.
Weight:	0.8 kg approx.

Digital Counter (230 V, 50/60 MHz)

U8533341-230

Digital Counter (115 V, 50/60 MHz)

U8533341-115



U8533341-230
U8533341-115

U8533430

Geiger Counter

Versatile, easy to use and compact precision instrument for measuring α-, β- and γ-radiation. With filter selection switch at the front of the Geiger-Müller counter tube for filtering out types of radiation (γ/β, γα/β or γ only), large display and integrated USB interface. Including USB cable, Windows software, and operating instructions. The following functions and operating modes are available for measurement:

- Standard mode for displaying the current radiation level. Display of the equivalent dose as a numerical value and as bar chart and display of the time until a selected cumulative dose limit is reached (default 5 µSv/h). Also equipped with variable acoustic and optical warning threshold signal and display of average radiation from previous day.
- Pulse counting either permanent or with variable gate time. Gate time adjustable in seconds, minute or hours. Additional optional acoustic count indication.
- Count rate measurement. The pulses registered are measured successively and converted into a count rate (number of pulses per second).
- Integrated display of date and time for correct recording of measured radiation.
- The number of pulses registered is stored in the internal memory. This facilitates recording e.g. of weekly values for up to 10 years.
- Computer docking station. The software enables the measured data to be evaluated and processed on an MS-Windows PC.

Radiation types:	α from 4 MeV, β from 0.2 MeV, γ from 0.02 MeV
Measured variables:	equivalent dose in Sv/h, mSv/h, µSv/h pulses/s, pulses/variable time interval
Display:	LCD, 4 digit, numerical with display of measured variable, quasi analogue bar chart, operating mode indicators
Radiation detector:	End window Geiger-Müller counter tube, stainless steel housing with neon-halogen filling
Measuring length:	38.1 mm
Measuring diameter:	9.1 mm
Mica window:	1.5 – 2 mg/cm ²
Gamma sensitivity:	114 pulses/min for ⁶⁰ Co radiation = 1 µSv/h in background radiation energy band
Background rate:	10 pulses per minute approx.
Internal memory:	2 kilobytes
Battery life:	3 years approx.
Dimensions:	163x72x30 mm ³ approx.
Weight:	155 g approx.

U111511



U111511

Important note:

In accordance with radiation protection regulations, anyone who works with radioactive materials or ionising radiation or plans to do so has the following obligations:

- Avoid unnecessary exposure to radiation or contamination of persons or of the environment.
- Ensure that any unavoidable exposure to radiation or contamination of persons or of the environment is below the limits specified by the regulations and is reduced to the minimum that is possible with present science and technology, taking into account all the circumstances of the case.



Dosimeter Radex RD 1706

Used for determining dose rates in $\mu\text{Sv/h}$ for β -, γ - and X-rays, this radiation meter can be operated by non-professionals while nonetheless offering the features of a professional dosimeter. Including two built-in Geiger-Müller counter tubes and a large, illuminated LCD display. The device measures the activity of β - and γ -particles and uses the results to calculate the dose rate. Depending on dose rate, the measurement and calculation times vary from 26 s to 1 s at high dose rates. Detection of each particle is indicated by an audio signal to facilitate searching for radioactive sources. The difference between the mean dose rate and background radiation level, as well as the background radiation level itself are displayed in the "background" mode. This facilitates, for example, inspections of enclosed spaces and building materials. Overshoot of an adjustable alarm threshold can be indicated either by an audio signal or a vibration signal. Measured values remain saved after the device has been turned off.

Counters:	Two GM counter tubes SBM20-1
Measurement variable:	Ambient equivalent dose rate $H^*(10)$
Measuring range:	0.05 – 999.0 $\mu\text{Sv/h}$
Alarm threshold:	Adjustable from 0.10 to 99.0 $\mu\text{Sv/h}$
Alarm:	Audio or vibration signal
Measurement and calculation times:	26 s
	1 s (at $H^*(10) > 3.5 \mu\text{Sv/h}$)
Value display duration:	Continuous
Energy detection range	
X-radiation and γ -radiation:	0.03 to 3.0 MeV
β -radiation:	0.25 to 3.5 MeV
Batteries:	1.5 V, AAA (1 x or 2 x)
Operating time:	500 h, with 2 batteries (1350 mAh) under normal conditions
Dimensions:	105x60x26 mm ³
Weight (without batteries):	90 g

U8557150

Spinthariscopes

Detection instrument for observing scintillations produced by radioactive decay. When a radiation cartridge (^{226}Ra , 4 kBq, U8483115) is screwed into the instrument so that its radiation outlet is directed downwards onto the exposed zinc sulphide screen, it is possible to look through the eyepiece of the instrument in total darkness and observe the random light flashes that are caused by radioactive decay. Screen: 15x15 mm²

U8482490

Additionally required:

U8483115 Radiation Cartridge, ^{226}Ra , 4 kBq

Cloud Chamber

Expansion cloud chamber for observing the paths of α -rays. Cover and sidewall are of plexiglas. With threaded hole for inserting the ^{226}Ra , 4 kBq radiation cartridge (U8483115), hinged absorption foil for opening and closing the beam outlet and carrying handle at the side. By compressing the attached rubber ball and then allowing it to expand, a supersaturated methanol-water mixture is produced in the cloud chamber. Following that, the paths of the α -rays revealed by droplet formation are visible for 1 – 2 seconds in the light of an optical lamp.

U8483220

Additionally required:

U8483115 Radiation Cartridge, ^{226}Ra , 4 kBq

Radiation Cartridge, ^{226}Ra , 4 kBq

Regulation-exempt radiation source with brass container for shielding. Radium sulphate rolled in gold foil and sealed at one end of a stainless steel cartridge.

Activity:	4 kBq
Weight:	400 g approx.

U8483115

Note:

In Germany, the ^{226}Ra radiation cartridge is authorised for unlimited use. Its activity is approximately 4 kBq, whereas the limit for unlimited use of ^{226}Ra is around 10 kBq. The ^{226}Ra radiation cartridge can be used on its own in Germany without any authorisation or notice as long as the so-called "sum rule" is adhered to. Otherwise, it is necessary to obtain authorisation from the appropriate authority. The "sum rule" states that the percentage contribution from all samples or nuclides present must not exceed 100% of the authorised limits. Such a limit may be exceeded if as many as three ^{226}Ra radiation cartridges or even a small number of other samples or nuclides are present. In other countries, it is necessary to observe the legal regulations stipulated there.

Caution: Hazardous item. For this reason there will be additional transport costs.



Nal(Tl) Scintillation Detector

An energy-sensitive detector for identifying γ -ray and X-ray fluorescent radiation with high probability. It can record energy spectra, which can be calibrated, and measure the relative intensity of the radiation. Incoming radiation causes a thallium-doped sodium iodide crystal to emit brief pulses of light, which are then converted into electrical pulses in proportion to the energy of the radiation by means of a photomultiplier affixed to the apparatus. The crystal is protected against light penetrating from outside by a thin aluminium cover. The photomultiplier is protected from interference by external magnetic fields by means of mu-metal shielding.

- Relative energy resolution: 8% approx. at 662 keV
- Connector socket: 14-pin, with centring aid
- Dimensions of crystal : 51 mm x 51 mm diam. approx.
- Aluminium cover: 0.5 mm approx.
- Overall dimensions 185 mm x 58 mm diam. approx.

U46000

Additionally required:
U46010 Nal Operating and Evaluation Unit

Additionally recommended:
U8483115 Radiation Cartridge, ^{226}Ra , 4 kBq



Radioactivity

Nal Operating and Evaluation Unit

Complete apparatus for operation and evaluation, designed for measurement and comprehensive evaluation of energy spectra. Consists of a 14-pin connector stage with a high-voltage power supply for the photomultiplier of an Nal(Tl) scintillation detector. Possesses an integrated amplifier with pulse-shaping capability and digital signal processing for four-channel analysis. The power supply for the complete unit is provided via the USB port of a PC. Includes MAESTRO 32 measurement and evaluation software for a PC. The measurement and evaluation software has a versatile graphic user interface, supports identification of the measured radiation energies with the aid of integrated libraries and allows for the setting of all measurement parameters, including the high-voltage supply, from the PC.

- Resolution: 1024 channels
- Amplification: 1, 3 or 9 (coarse) 0.4 – 1.2 (fine)
- Integral non-linearity: <0.05% over 99% of the range
- Differential non-linearity: <1% over 99% of the range
- Effect of lag: <5% for less than 50000 events per second
- High-voltage supply: 0 to 1200 V DC
- Amplifier drift: <0.15x10⁻³ per °C
- Offset drift: <0.05x10⁻³ per °C
- Pulse shaping: 0.75 – 2 μs

U46010

Additionally required:
U46000 Nal(Tl) Scintillation Detector

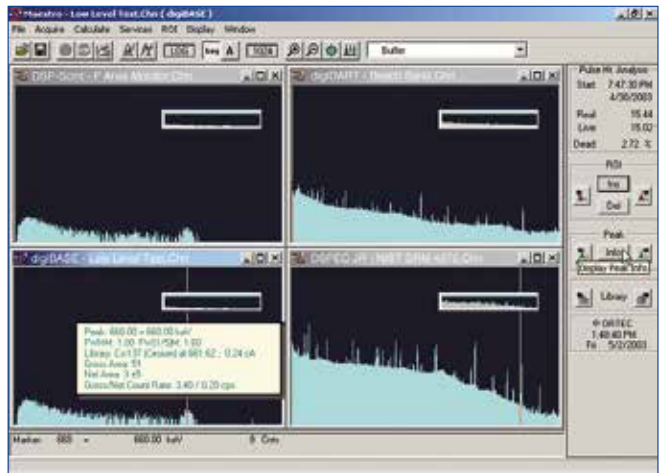

Screenshot of the measurement and evaluation software MAESTRO 32

Warning Notice: "Radioactive"

- Warning notice on white plastic. On stem.
- Dimensions: 210x300 mm² approx.
- Weight: 80 g approx.

U8483218

Steel Safe for Radioactive Materials

- Steel safe for theft proof storage of radioactive materials in accordance with radiation protection requirements.
- Dimensions: 140x300x360 mm³ approx.
- Weight: 3 kg approx.

U8483219



Atomic and Nuclear Physics

ESR/NMR Basic Set

This basic equipment set is intended for investigating the electron spin resonance (ESR) of an unpaired electron of a DPPH sample as well as the nuclear magnetic resonance (NMR) of glycerine, teflon and polystyrene. Resonances are observed via transitions induced through high frequencies resulting from changes in the external magnetic field. Resonance absorption curves can be represented with a simple dual-channel oscilloscope or with the 3B NET/log™ unit.

Contents:

- 1 Basic unit
- 1 Pair of coils
- 1 Control panel
- 1 Plug-in power supply, 12 V AC (230 V, 50/60 Hz)
- or
- 1 Plug-in power supply, 12 V AC (115 V, 50/60 Hz)

The basic unit is a mechanical base for test samples as well as ESR (from U188501) or NMR probes (from U189021), a coil pair and a permanent magnet (from U189021).

Dimensions: 165x105x135 mm³ approx.
Weight: 1.25 kg approx.

The coil pair is used to generate the variable magnetic field for electron spin resonance and – in conjunction with the permanent magnet (from U189021) – nuclear spin resonance.

Magnetic flux density: 0 – 3.7 mT
Connection: Barrel connector
Dimensions: 20 mm x 74 mm diam. approx. each
Weight: 0.2 kg approx. each

The control console provides the voltage for control and supply of power to probes and the coil pair. It also processes the signal for display on an oscilloscope and indicates the frequency of the high-frequency signal.

Probe connection: Four-pin Lemo socket
Coil pair connection: Saw-tooth current source, 0 – 250 mA, 50 ms, pair of barrel sockets
Field output: Proportional to coil current, 0 to 1 V, BNC socket
Signal output: Resonance signal, 0 to 1 V, BNC socket
Frequency range: 45 to 75 MHz approx. (ESR)
10 to 15 MHz approx. (NMR)
Dimensions: 170x105x45 mm³ approx.
Weight: 0.5 kg approx.

Experimental topics:

- Resonance absorption of a high-frequency oscillating circuit
- Dependence of resonance frequency on magnetic fields
- Line width
- Electron spin
- Magnetic moment of an electron
- Determination of the electron g factor
- Proton spin
- Magnetic moment of a proton and nucleus
- Determination of the nucleus g factor
- Nuclear-spin tomography

ESR/NMR Basic Set (230 V, 50/60 Hz)

U188031-230

ESR/NMR Basic Set (115 V, 50/60 Hz)

U188031-115

Additionally required:

U188501 ESR Supplementary Set

or

U189021 NMR Supplementary Set

U11175 Analogue Oscilloscope, 2x30 MHz

or

U11300-230 3B NET/log™ (230 V, 50/60 Hz)

or

U11300-115 3B NET/log™ (115, 50/60 Hz)



U188031-230
U188031-115



UE5030200
PDF online



NMR Supplementary Set

Supplementary set for ESR/NMR basic set (U188031-230 or U188031-115) for experiments on nuclear magnetic resonance using three different samples. Consists of an NMR probe-head with radio frequency coil, a permanent magnet giving a highly uniform field, a sample of glycerine, a sample of polystyrene, a sample of Teflon, an empty sample tube for comparison and two mounting discs.

Connection to the probe-head: Four-pin Lemo plug
Magnetic flux density of permanent magnet: 300 mT approx.

U189021



U189021

ESR Supplementary Set

Supplementary set for ESR/NMR basic set (U188031-230 or U188031-115) for experiments on electron spin resonance using DPPH. Consists of an ESR probe-head with radio frequency coil, a sample of DPPH (diphenyl picryl hydrazyl), an empty sample tube for comparison, two mounting rings and two mounting cylinders.

Connection to the probe-head: Four-pin Lemo plug

U188501



U188501

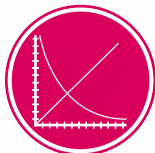

UE5030100
PDF online

U188501



U11175

U188031-230
U188031-115

Experiment topics:

- Hall effect in semiconductors
- Extrinsic conductivity
- Intrinsic conductivity
- Mobility of electrons and holes
- Drift velocity of charge carriers
- Carrier concentration
- Band separation

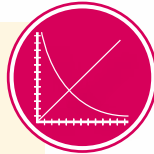

UE6020100
UE6020200
PDF online



Experiment set-up:
Hall effect in semiconductors

Basic Hall Effect Apparatus

Basic apparatus for providing contact, power supply and support to a germanium crystal on a circuit board (U8487010, U8487020 and U8487030) in experiments on the Hall effect or on conductivity. Includes an integrated, adjustable constant current source to provide the current through the sample, a measuring amplifier with offset compensation for Hall voltages and heating to raise the crystal to as high as 170°C, also featuring temperature regulation and a switchable display showing Hall voltage, sample current, sample voltage or temperature. Hall voltage and sample voltage can be tapped directly from the front panel. In addition three equivalent voltage outputs for Hall voltage, sample current and sample temperature can be measured from the side. Includes an attachment for assembling the apparatus on the U-shaped core (U8497215) of a transformer assembly kit and 2 connecting leads with 8-pin miniDIN plugs.

Outputs for

equivalent voltages:	4-mm safety sockets
	8-pin miniDIN sockets (for 3B NET/og™)
Power supply:	12 V AC, 3 A via 4-mm sockets
Dimensions:	180x110x50 mm ³ approx.
Weight:	0,5 kg approx.

U8487000

N-Doped Germanium on Printed Circuit Board

High-quality interchangeable board with an n-doped germanium crystal for investigating the conductivity and Hall potential for n-doped germanium as a function of temperature. With contacts for transverse current and Hall potential, integrated resistive heating element with temperature sensor directly under the crystal, and multi pin plug for connecting the circuit board to the basic Hall effect apparatus (U8487000).

Crystal dimensions:	20x10x1 mm ³ approx.
Overall dimensions:	70x70x10 mm ³ approx.
Weight:	30 g approx.

U8487030

Additionally required:
U8487000 Basic Hall Effect Apparatus

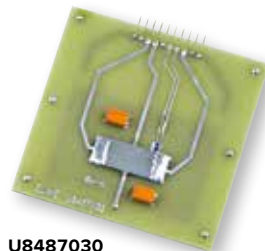

U8487030



U8487000

Undoped Germanium on Printed Circuit Board

High-quality interchangeable board with an undoped germanium crystal for investigating the conductivity of undoped germanium as a function of temperature. With contacts for transverse current, integrated resistive heating element with temperature sensor directly under the crystal, and multi pin plug for connecting the circuit board to the basic Hall effect apparatus (U8487000).

Crystal dimensions:	20x10x1 mm ³ approx.
Overall dimensions:	70x70x10 mm ³ approx.
Weight:	30 g approx.

U8487010

Additionally required:
U8487000 Basic Hall Effect Apparatus

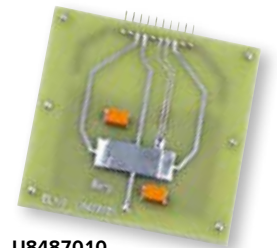

U8487010

Doped Germanium on Printed Circuit Board

High-quality interchangeable board with an p-doped germanium crystal for investigating the conductivity and Hall potential for p-doped germanium as a function of temperature. With contacts for transverse current and Hall potential, integrated resistive heating element with temperature sensor directly under the crystal and multi pin plug for connecting the circuit board to the basic Hall effect apparatus (U8487000).

Crystal dimensions:	20x10x1 mm ³ approx.
Overall dimensions:	70x70x10 mm ³ approx.
Weight:	30 g approx.

U8487020

Additionally required:
U8487000 Basic Hall Effect Apparatus

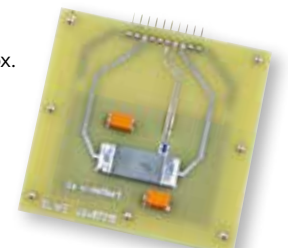

U8487020

Experiment “Electrical Conduction in Semiconductors – Determine band separation in germanium”

- 1 Basic Hall Effect Apparatus U8487000
- 1 Undoped Germanium on Printed Circuit Board U8487010
- 1 Barrel Foot, 1000 g U13265
- 1 Transformer with Rectifier 3/ 6/ 9/12 V, 3 A (230 V, 50/60 Hz) U33300-230
- or
- 1 Transformer with Rectifier 3/ 6/ 9/12 V, 3 A (115 V, 50/60 Hz) U33300-115
- 1 Digital Multimeter P3340 U118091
- 1 Pair of Safety Experiment Leads, 75 cm U13812
- 1 Pair of Safety Experiment Leads, 75cm, red/blue U13816
- 1 3B NET/log™ (230 V, 50/60 Hz) U11300-230
- or
- 1 3B NET/log™ (115 V, 50/60 Hz) U11300-115
- 1 3B NET/lab™ U11310

Experiment “Hall-effect in p- and n-doped germanium”

- 1 Basic Hall Effect Apparatus U8487000
- 1 N-Doped Germanium on Printed Circuit Board U8487030
- 1 Doped Germanium on Printed Circuit Board U8487020
- 1 Magnetic Field Sensor ±2000 mT U11359
- 1 Coil D with 600 turns U8497430
- 1 U-core U8497215
- 1 Pair of Pole Shoes and Clamping Brackets D for Hall Effect U8497205
- 1 Transformer with Rectifier 3/ 6/ 9/12 V, 3 A (230 V, 50/60 Hz) U33300-230
- or
- 1 Transformer with Rectifier 3/ 6/ 9/12 V, 3 A (115 V, 50/60 Hz) U33300-115
- 1 DC Power Supply 0 – 20 V, 0 – 5 A (230 V, 50/60 Hz) U33020-230
- or
- 1 DC Power Supply 0 – 20 V, 0 – 5 A (115 V, 50/60 Hz) U33020-115
- 1 Digital Multimeter P3340 U118091
- 1 Set 15 Safety Experiment Leads 75 cm U138021
- 1 3B NET/log™ (230 V, 50/60 Hz) U11300-230
- or
- 1 3B NET/log™ (115 V, 50/60 Hz) U11300-115
- 1 3B NET/lab™ U11310

Experiment Topics:

- Hall effect in metals
- Normal and anomalous Hall effect
- Hall coefficient

Hall Effect in Metals

For verifying the existence of a Hall-effect voltage across a copper or zinc sample being supplied with a current I and located in a magnetic field acting perpendicular to the direction of the current. Ready-to-use samples are soldered onto a printed circuit board with 4-mm connection sockets. The Hall effect mounting is required in order to attach the sample within the magnetic field of an electromagnet.

- Thickness of copper sample: 17.5 μm
- Max. current through copper sample: 20 A DC
- Thickness of zinc sample: 25μm
- Max. current through zinc sample: 15 A DC
- Sample surface area: 10x44 mm²
- Dimensions: 130x90x25 mm³ approx.
- Weight: 45g approx.

Copper Sample for Hall Effect

U8557400

Zinc Sample for Hall Effect

U8557410

Holder for Hall Effect

U8557420

Required to generate magnetic field:

- U8497430 Coil D with 600 Taps (2x)
- U8497215 U Core D
- U8497205 Pair of Pole Shoes and Clamping Brackets D for Hall Effect
- U33020-230 DC-Power Supply 0 – 20 V, 0 – 5 A (230 V, 50/60 Hz)
- or
- U33020-115 DC-Power Supply 0 – 20 V, 0 – 5 A (115 V, 50/60 Hz)

Additionally required:

- U117361 DC Power Supply 0 – 16 V, 0 – 16 A
- U8530501-230 Microvoltmeter (230 V, 50/60 Hz)
- or
- U8530501-115 Microvoltmeter (115 V, 50/60 Hz)
- U8533982 Teslameter E
- U8533999 Flexible Magnetic Field Sensor

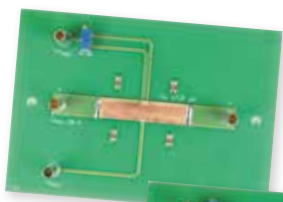

U8557400



U8557410



U8557420



Experiment set-up: Hall effect in metals



U13900-115

U13900-230

U8475470-230
U8475470-115

UK Adaptors Included

Power Supply for Optical Lamps

Powerful electronic power supply, e.g. for the operation of lamps as used in optics. Short circuit proof, with connection leads and two cascadable 4 mm safety plugs.

Output: 12 V, max. 5 A

Transformer 12 V, 60 VA (230 V, 50/60 Hz)

Dimensions: approx. 100x45x70 mm³

U13900-230

Transformer 12 V, 60 VA (115 V, 50/60 Hz)

Dimensions: approx. 75x45x45 mm³

U13900-115

Transformer 12 V, 25 VA

Simple transformer for student exercises. Short circuit proof, with connection leads and two cascadable 4 mm safety plugs.

Output: 12 V AC, max. 2 A

Dimensions: approx. 110x95x65 mm³

Weight: approx. 0.64 kg

Transformer 12 V, 25 VA (230 V, 50/60 Hz)

U8475470-230

Transformer 12 V, 25 VA (115 V, 50/60 Hz)

U8475470-115



U33200-230
U33200-115

Plug In Power Supply 24 V, 700 mA

Plug in 24 V power supply for the operation of a Pohl torsion pendulum (U15040). With 2 m lead and two stackable 4 mm safety plugs.

Output: 24 V AC, max. 700 mA

Plug In Power Supply 24 V, 700 mA (230 V, 50/60 Hz)

U33200-230

Plug In Power Supply 24 V, 700 mA (115 V, 50/60 Hz)

U33200-115



U9004673

U9004674



U8521385

U8521380

Plug-In Power Supply, 12 V AC

Plug-in power supply with coaxial power connector.

Art. No.	Voltage	Max. current	Power Connector	Mains voltage
U9004673	12 V AC	2000 mA	5.5x2.5 mm	230 V, 50/60 Hz
U9004674	12 V AC	2000 mA	5.5x2.5 mm	115 V, 50/60 Hz
U8521385	12 V AC	750 mA	5.5x2.1 mm	230 V, 50/60 Hz
U8521380	12 V AC	500 mA	5.5x2.1 mm	115 V, 50/60 Hz



U117401-230

Voltage Regulating Transformer (230 V, 50/60 Hz)

High performance voltage regulating transformer with high load capacity and continuously adjustable AC output voltage. Two digital rms displays for current strength and output voltage. Thermally protected against overload with an overcurrent circuit breaker. Output electrically isolated from mains input.

- Output: 0 – 260 V AC, max. 3 A
- Overload protection: Thermal
- Display: 3 digit LCD
- Connection: earthed socket outlet
- Power: 780 VA
- Voltage supply: 230 V ±10% 50/60 Hz
- Dimensions: approx. 250x235x178 mm³
- Weight: approx. 20 kg

U117401-230

**Robust,
simple
and clearly
laid out**

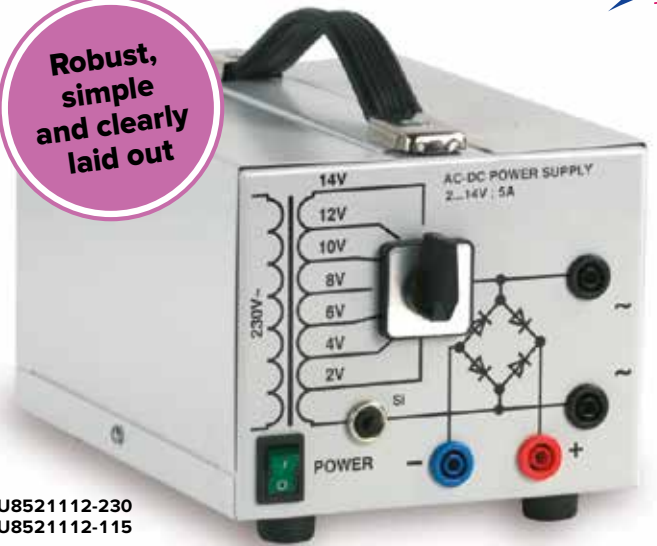

**U8521112-230
U8521112-115**

Transformer with Rectifier 2/ 4/ 6/ 8/ 10/ 12/ 14 V, 5 A

Safety isolating transformer with safety cut out contained in metal housing. Output voltage switchable in 7 steps

- AC output: 2/ 4/ 6/ 8/ 10/ 12/ 14 V, max. 5 A
- DC output: 2/ 4/ 6/ 8/ 10/ 12/ 14 V, max. 5 A
- Terminals: 4 mm safety sockets
- Dimensions: approx. 260x140x130 mm³
- Weight: approx. 3.1 kg

Transformer with Rectifier 2/ 4/ 6/ 8/ 10/ 12/ 14 V, 5 A (230 V, 50/60 Hz)

U8521112-230

Transformer with Rectifier 2/ 4/ 6/ 8/ 10/ 12/ 14 V, 5 A (115 V, 50/60 Hz)

U8521112-115



U8498305

refer also to page 136

Table-Top Power Supply

Table-top power supply for supply of power to the heat conduction equipment set.

- Mains voltage: 100 – 240 V AC/1 A, 50/60 Hz
- Output voltage: 12 V DC/4 A

U8498305

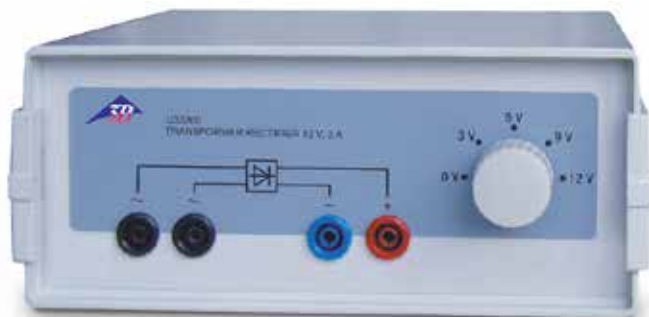

**U33300-230
U33300-115**

Transformer with Rectifier 3/ 6/ 9/ 12 V, 3 A

Extra low voltage power supply with overload protection contained in plastic housing. Output voltage switchable in four stages.

- AC output: 3/ 6/ 9/ 12 V, max. 3 A
- DC output: 3/ 6/ 9/ 12 V, max. 3 A
- Terminals: 4 mm safety sockets
- Dimensions: approx. 210x170x90 mm³
- Weight: approx. 2.6 kg

Transformer with Rectifier 3/ 6/ 9/ 12 V, 3 A (230 V, 50/60 Hz)

U33300-230

Transformer with Rectifier 3/ 6/ 9/ 12 V, 3 A (115 V, 50/60 Hz)

U33300-115



U117601-230
U117601-115

AC/DC Power Supply 0 – 12 V, 3 A

Extra low voltage power supply with continuously adjustable, stabilised and regulated DC output voltage and illuminated, analogue display panel. DC voltage output is short circuit proof and noise voltage proof. Four AC outputs galvanically isolated from the DC voltage outputs are overload protected via semiconductor fuses (multifuses).

- DC output: 0 – 12 V, max. 3 A
- Stability under full load: ≤ 20 mV
- Residual ripple under full load: ≤ 2 mV
- Analogue display: class 2.5
- AC outputs: 3, 6, 9, 12 V, max. 3 A
- Terminals: 4 mm safety sockets
- Dimensions: approx. 230x115x190 mm³
- Weight: approx. 3.5 kg

AC/DC Power Supply 0 – 12 V, 3 A (230 V, 50/60 Hz)

U117601-230

AC/DC Power Supply 0 – 12 V, 3 A (115 V, 50/60 Hz)

U117601-115



U8521105-230
U8521105-115

AC/DC Power Supply 0 – 12 V, 3 A, stab.

Extra low voltage power supply with continuously adjustable, stabilised DC voltage or stabilised AC voltage. Selection between DC and AC output voltage is performed using a toggle switch.

- DC output: 0 – 12 V, max. 3 A, stabilised
- AC output: 0 – 12 V, max. 3 A, stabilised
- Dimensions: approx. 160x170x65 mm³
- Weight: approx. 2.9 kg

AC/DC Power Supply 0 – 12 V, 3 A, stab. (230 V, 50/60 Hz)

U8521105-230

AC/DC Power Supply 0 – 12 V, 3 A, stab. (115 V, 50/60 Hz)

U8521105-115



U117301-230

AC/DC Power Supply 0 – 30 V, 5 A (230 V, 50/60 Hz)

Continuously adjustable AC/DC power supply unit with digital displays for voltage and current readings, particularly suitable for experiments for students and trainees. The outputs are galvanically isolated. A pushbutton can be used to turn the capacitor filtration of the output direct voltage on and off (smoothing). In the event of an overload, the device is turned off by a thermal overload protection switch.

- DC output: 0 – 30 V, max. 5 A
- AC output: 0 – 30 V, max. 5 A
- Max. output power: 150 VA
- Display: 2x 3 digit LED
- Digit height: 15 mm
- Connections: 4 mm jacks
- Voltage supply: 230 V $\pm 10\%$ 50/60 Hz
- Dimensions: approx. 280x205x140 mm³
- Weight: approx. 8.3 kg

U117301-230



U8521131-230
U8521131-115

AC/DC Power Supply 0 – 20 V, 0 – 5 A

Power supply with adjustable and stabilised DC voltage and analogue voltage and current display for DC voltage. The DC voltage component features an automatically alternating voltage and current control and is protected against continuous short circuits. The AC voltage can be selected in eight steps, the output is protected by an overcurrent circuit breaker. The AC and DC voltage outputs are DC isolated. A temperature regulated fan protects the unit from overheating.

- DC output: 0 – 20 V, 0 – 5 A
- AC output: 2, 4, 6, 8, 10, 12, 15, 20 V, max. 5 A
- Ripple U: < 10 mV
- Dimensions: approx. 235x175x245 mm³
- Weight: approx. 8 kg

AC/DC Power Supply 0 – 20 V, 5 A (230 V, 50/60 Hz)

U8521131-230

AC/DC Power Supply 0 – 20 V, 5 A (115 V, 50/60 Hz)

U8521131-115



U33030-230
U33030-115

AC/DC Power Supply 1/ 2/ 3/...15 V, 10 A

AC and DC power supply adjustable to various levels and housed in metal case. Particularly suitable for experiments by pupils and for lab practicals. Features stabilised DC voltages. Outputs are galvanically isolated and short-circuit-proof.

- DC output: 1/ 2/ 3/ 4/ 5/ 6/ 7/ 8/ 9/ 10/ 11/ 12/ 13/ 14/ 15 V, max. 10 A
- AC output: 1/ 2/ 3/ 4/ 5/ 6/ 7/ 8/ 9/ 10/ 11/ 12/ 13/ 14/ 15 V, max. 10 A
- Max. output power: 150 VA
- Connections: 4 mm jacks
- Dimensions: approx. 170x160x250 mm³
- Weight: approx. 6.3 kg

AC/DC Power Supply 1/ 2/ 3/...15 V, 10 A (230 V, 50/60 Hz)

U33030-230

AC/DC Power Supply 1/ 2/ 3/...15 V, 10 A (115 V, 50/60 Hz)

U33030-115

Usable as a current source



U33035-230
U33035-115

AC/DC Power Supply, 0 – 30 V, 0 – 6 A

Combined power supply with separate AC and DC outputs plus separate displays of output voltage and current. The DC output can be used as a voltage source or current source and can be set to any value within its range. The AC output features current limiting and is electronically protected against overload.

- DC voltage: 0...30 V
- DC current: 0...6 A
- AC voltage: 0...30 V
- AC current: max. 6 A
- Dimensions: 380x140x300 mm³ approx.
- Weight: 12 kg approx.

AC/DC Power Supply 0 – 30 V, 0 – 6 A (230 V, 50/60 Hz)

U33035-230

AC/DC Power Supply 0 – 30 V, 0 – 6 A (115 V, 50/60 Hz)

U33035-115

with current limiting



U8521400-230
U8521400-115

DC Power Supply 450 V

Power supply with three outputs for the electric supply in experiments with the Electrometer (U8531408-230 resp. U8531408-115).

- Output 1:
 - Voltage: 0 – 450 V DC
 - Max. current: 10 µA
- Output 2:
 - Voltage: 1.2 – 12 V DC
 - Max. current: 100 mA
- Output 3:
 - Voltage: 0 – 12 V AC
 - Max. current: 10 mA
- Dimensions: approx. 250x100x160 mm³
- Weight: approx. 0.8 kg

DC Power Supply 450 V (230 V, 50/60 Hz)

U8521400-230

DC Power Supply 450 V (115 V, 50/60 Hz)

U8521400-115



U8521121-230

DC Power Supply 1.5 – 15 V, 1.5 A (230 V, 50/60 Hz)

Handy DC power supply contained in a sturdy metal housing. The output voltage is continuously adjustable and is displayed via an analogue measuring instrument. The output is short circuit proof and floating.

- Output voltage: 1.5 – 15 V, max. 1.5 A
- Residual ripple: 10 mV
- Terminals: 4 mm safety sockets
- Voltage supply: 230 V ±10% 50/60 Hz
- Dimensions: approx. 100x80x150 mm³
- Weight: approx. 2 kg

U8521121-230



U11710-230
U11710-115

Usable as
a current
source



U117361

DC Power Supply

Universal power supply with a digital display for voltage and current. The output voltage and current are continuously adjustable. The device can be used as a constant voltage supply with current limiting or as a constant current supply with voltage limiting. Two or more devices can be operated in parallel or series.

Display: 2x 3 digit LED
Accuracy: 1% + 2 digits for U , 1% + 4 digits for I
Terminals: 4 mm safety sockets
Dimensions: approx. 210x132x255 mm³

	U11705-230 U11705-115	U11710-230 U11710-115
Output voltage	0 – 16 V	0 – 32 V
Output current	0 – 10 A	0 – 2.5 A
Output power	160 W	80 W
Stability under full load	≤10 mV	≤10 mV
Residual ripple	≤4 mV	≤4 mV
Weight	ca. 5.9 kg	ca. 5.3 kg

DC Power Supply 0 – 16 V, 0 – 10 A (230 V, 50/60 Hz)

U11705-230

DC Power Supply 0 – 32 V, 0 – 2.5 A (230 V, 50/60 Hz)

U11710-230

DC Power Supply 0 – 16 V, 0 – 10 A (115 V, 50/60 Hz)

U11705-115

DC Power Supply 0 – 32 V, 0 – 2.5 A (115 V, 50/60 Hz)

U11710-115



U33020-230
U33020-115

Usable as
a current
source



U11827-230
U11827-115

DC Power Supply 0 – 16 V, 0 – 20 A

DC high current power supply with digital display of voltage and current. The voltage and current are continuously adjustable by means of coarse and fine controllers. The device can be used as a constant voltage source with current limiting, or a constant current source with voltage limiting. The selected operating mode is indicated by an LED on the front panel. High reliability even under extremely adverse conditions is ensured by automatic transformer switchover, MOSFET power amplifiers and temperature controlled fan speed with monitoring function. This equipment is also provided with a preset function for protecting against excess current and voltage. The design of the device omits any air vents at the top or bottom and does not require an external heat sink. The output is protected against sustained short circuits. Two or more such units can be operated in series or in parallel.

DC output: 0 – 16 V, 0 – 20 A
Fine adjustment range U : 800 mV
Stability at 0 – 100% load: <12 mV
Residual ripple: <1 mV
Fine-adjustment range I : 2 A
Connections: 4 mm jacks
Mains connection: 115 V/230 V, 50/60 Hz
Dimensions: approx. 240x120x300 mm³
Weight: approx. 10 kg

U117361

DC Power Supply 1 – 32 V / 0 – 20 A

High-quality switched-mode power supply in space-saving housing with intelligent control of fan speed to ensure safe and quiet operation. Simple, precise and fast adjustment of voltage and current levels with dual-function rotary knobs for coarse and fine adjustment. Adjustable current limiting in open circuit. Three user-definable stored configurations for voltage and current limiting make it easy to recall frequently used settings. Full remote control of voltage and current plus output which can be turned on and off.

Display: 3-digit, 15 mm, green LED
Output voltage: 1 – 32 V DC
Output current: 0 – 20 A (output with pole terminals on rear)
0 – 5 A (output with 4-mm safety sockets on front)
Max. power output: 640 W
Residual ripple: 5 mV rms
Efficiency: > 87.0 %
Dimensions: approx. 200x90x255 mm³
Weight: 2.6 kg

DC Power Supply, 1 – 32 V / 0 – 20 A (230 V, 50/60 Hz)

U11827-230

DC Power Supply, 1 – 32 V / 0 – 20 A (115 V, 50/60 Hz)

U11827-115

DC Power Supply 0 – 20 V, 0 – 5 A

Universal power supply with digital current and voltage display. Output voltage and output current are continuously adjustable. The device can be used as a constant voltage source with current limiting or as a constant current source with voltage limiting.

DC output: 0 – 20 V, 0 – 5 A
Output power: 100 W
Stability under full load: ≤0.01% + 5 mV, ≤0.2% + 5 mA
Residual ripple: ≤1 mV, 3 mA
Display: 2x 3 digit LED
Terminals: 4 mm safety sockets
Dimensions: approx. 130x150x300 mm³
Weight: approx. 4.7 kg

DC Power Supply 0 – 20 V, 0 – 5 A (230 V, 50/60 Hz)

U33020-230

DC Power Supply 0 – 20 V, 0 – 5 A (115 V, 50/60 Hz)

U33020-115

4
outputs



U33010-230
U33010-115

U33000-230
U33000-115

DC Power Supply 0 – 500 V

Low voltage power supply with four outputs primarily intended to supply power for electron tubes and Helmholtz coils simultaneously, with four independently adjustable DC voltages and analogue dials for each of them. The DC voltages are stabilised and regulated, floating and galvanically isolated from one another, short circuit proof and secure from external voltages.

- 500 V output: 0 – 500 V DC, max. 50 mA
- 50 V output: 0 – 50 V DC, max. 50 mA
- 8 V output: 0 – 8 V DC, max. 3 A
- 12 V output: 0 – -12 V DC, max. 4 A
- Displays: Analogue, class 2
- Connections: 4 mm safety sockets
- Power consumption: 50 VA
- Dimensions: 85x325x190 mm³ approx.
- Weight: 4 kg approx.

DC Power Supply 0 – 500 V (230 V, 50/60 Hz)

U33000-230

DC Power Supply 0 – 500 V (115 V, 50/60 Hz)

U33000-115

! Ideal for operation of numerous electron tubes (cf. pages 232 ff)

- Regulated high-voltage output not dependent on mains voltage
- High-voltage-proof supply for heater voltage

High Voltage Power Supply 5 kV

Universally applicable, floating, high-voltage source for operation of electron tubes. With built in, high voltage resistant transformer to supply the heater voltage for electron tubes. Continuously adjustable high voltage, safe to touch, with passive current limitation and analogue voltage display.

- High voltage output: 0 – -5000 V DC, max. 2 mA, max. 5 W
- Heater voltage output: 6.3 V AC, max. 3 A, high voltage resistant up to 5 kV
- Overload protection: Primary: fuse
Secondary: current-limiting resistors
- Connections: 4 mm safety sockets
- High-voltage display: Analogue
- Dimensions: 235x130x155 mm³ approx.
- Weight: 3.5 kg approx.

High Voltage Power Supply 5 kV (230 V, 50/60 Hz)

U33010-230

High Voltage Power Supply 5 kV (115 V, 50/60 Hz)

U33010-115

U8521371-230
U8521371-115



With ramp generator

DC Power Supply 0 – 300 V

Low voltage power supply for operating tubes. In addition, a ramp generator is available for experiments on the law of induction and the charging and discharging of capacitors.

- Outputs: 0 – 300 V DC, max. 200 mA/
0 – -50 V DC, max. 10 mA/
4 – 12 V DC, max. 400 mA
- Ramp generator: 2.5 – 50 V/s, linear rising or falling
- Operating voltage: 230/115 V AC, 50 (60) Hz
- Connections: 4 mm safety sockets
- Dimensions: 240x230x170 mm³ approx.
- Weight: 3.7 kg approx.

DC Power Supply 0 – 300 V (230 V, 50/60 Hz)

U8521371-230

DC Power Supply 0 – 300 V (115 V, 50/60 Hz)

U8521371-115

! Ideal for operation of numerous electron tubes (cf. pages 232 ff)

- Very high-quality and extremely lightweight equipment in modern casing
- 3-digit digital display for high voltage
- Regulated high-voltage output not dependent on mains voltage
- High-voltage-proof supply for heater voltage
- No need to change fuses

High-Voltage Power Supply E 5 kV

Universally applicable, floating high-voltage source for electrostatic experiments and for operating spectral tubes, gas discharge tubes and electron tubes. With built-in transformer resistance to external voltage to provide the heating voltage for electron tubes. Continuously adjustable high-voltage source, which is safe to touch, with passive current limiting and digital voltage display.

- High-voltage output: 0 – 5000 V DC, max. 2 mA, floating
- Heater voltage output: 6.3 V AC, max. 3 A, resistance to voltage up to 5 kV
- Overload protection: Reversible fuse, 3 A
- Connectors: 4-mm safety sockets
- Power consumption: 35 VA
- High-voltage display: 3-digit LED
- Dimensions: 240x220x90 mm³ approx.
- Weight: 2 kg approx.

High-Voltage Power Supply E 5 kV (230 V, 50/60 Hz)

U8498294-230

High-Voltage Power Supply E 5 kV (115 V, 50/60 Hz)

U8498294-115



U8498294-230
U8498294-115



U8533600-230
U8533600-115

Advantages

- Easy and accurate adjustment
- With built-in continuous sweep-mode
- Ideal for recording resonance curves

FG 100 Function Generator

Function generator with power amplifier for use in versatile student and practical experiments covering simple harmonic oscillation, AC electricity and induction. Featuring illuminated, digital display for frequency, signal form, offset and other parameters. The output is short-circuit protected as well as being protected against induced voltages and spark discharges, e.g. for when experiment leads are unintentionally pulled out while coils are connected. In internal sweep mode, one trigger pulse is output per cycle and the voltage output is proportional to the frequency. With retractable feet. Includes power supply.

Signals:

Frequency range: 0.001 Hz to 100 kHz
 Signal forms: Sine, square, triangular
 Offset: 0 to ±5 V, adjustable in 0.1 V steps

Output:

Output amplitude: 0 to 10 V, continuously adjustable
 Power output: 10 W, permanent
 Output current: 1 A, permanent, 2 A max.

Sweep:

Sweep modes: External, continuous internal, individual internal
 Frequency range: 1 Hz to 100 kHz

Stop/start

frequency ratio: Max. 1000:1, e.g. 2 Hz to 2 kHz max.
 Time range: 0.04 s to 1000 s
 External sweep: Start via trigger pulse or application of 0 to 5 V control voltage

Max. modulation

frequency: 200 Hz
 Internal sweep: Start and stop via Start/Stop button
 One trigger output per cycle plus proportional voltage

General data:

Power supply: Plug-in power supply, 12 V AC, 2 A
 Dimensions: 170x105x40 mm³
 Additional features: Fold-out feet

FG 100 Function Generator (230 V, 50/60 Hz)

U8533600-230

FG 100 Function Generator (115 V, 50/60 Hz)

U8533600-115



U8533510-230
U8533510-115

Power Function Generator

Function generator with external sweep capability including power amplifier designed to conduct experiments on simple harmonic oscillation, alternating current and induction. Can be used as a function generator, a stabilised current source or a power amplifier. Equipped with a digital frequency display showing value and unit and an electronic circuit to protect against capacitive and inductive overload.

Frequency display: 3½ digit LED display with 13 mm digit height
 Unit display: mHz, Hz, kHz

Function generator:

Waveform: Sinusoidal, triangular, square-wave
 Frequency range: 10 mHz – 100 kHz, 7 decades
 Output voltage: 0 – 20 V, 10 mA, short-circuit proof
 DC Offset: 0 – ±10 V
 Internal resistance: 10 mΩ
 Modulation: FM and AM via external generator
 Sweep range: sweep through 7 decades

Power unit:

Frequency range: 0 – 50 kHz
 Input impedance: 1 MΩ || 60 pF
 AF-gain: 10
 Max. output power: 30 W
 Dimensions: approx. 125x170x225 mm³
 Weight: approx. 6.5 kg

Power Function Generator (230 V, 50/60 Hz)

U8533510-230

Power Function Generator (115 V, 50/60 Hz)

U8533510-115

refer also to pages 100 and 205



U8533600-230
U8533600-115

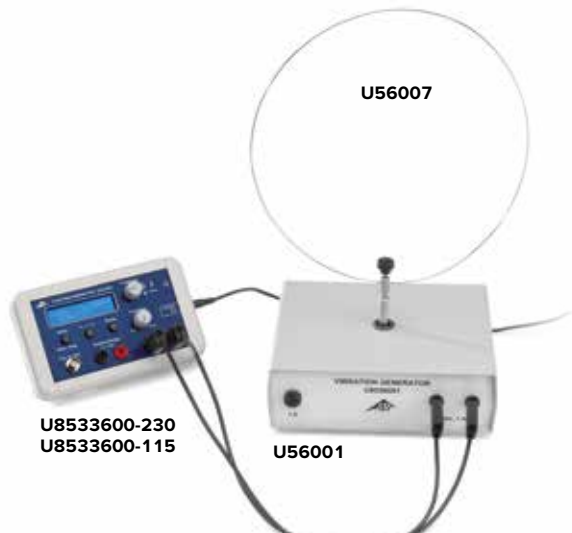

U8533600-230
U8533600-115

U56001

U56007

Experiments with the Function Generator SG10

Periodic reversal of the direction of rotation of a DC motor:

- U8498288-230 Function generator SG10 (230 V, 50/60 Hz)
- or
- U8498288-115 Function generator SG10 (115 V, 50/60 Hz)
- U8552330 DC motor 12 V
- U8611210 Barrel Foot
- U13812 Pair of safety experiment leads

Periodic changes in the display of a voltmeter:

- U8498288-230 Function generator SG10 (230 V, 50/60 Hz)
- or
- U8498288-115 Function generator SG10 (115 V, 50/60 Hz)
- U8557330 Analogue Multimeter ESCOLA 30
- U13812 Pair of safety experiment leads



Ideal for introductory student experiments



U8498288-230
U8498288-115

Function Generator SG 10

Sine-wave generator, which is particularly easy to use, featuring a power amplifier for use in student experiments. Includes 12 V AC plug-in power supply. One red and one green LED indicate the positive and negative half-waves of the output voltage. Their brightness corresponds to the configured amplitude. The way the output signal changes over time can be traced by means of an analog voltmeter with zero-point in the centre or by means of an oscilloscope. The output is protected against short-circuits and against induced voltages as well as spark discharges.

Signal form:	Sine-wave
Frequency range:	0.01 – 10 Hz
Output amplitude:	1 – 10 V _{pp} , continuously adjustable
LED display:	As of 2 V output voltage
Output power:	1.5 W permanent
Output current:	300 mA max.
Distortion factor:	<5%
Connectors:	4-mm safety sockets
Power supply:	12 V AC, 500 mA plug-in power supply
Dimensions:	100x75x35 mm ³ approx.
Weight:	400 g approx. including plug-in supply

Function Generator SG10 (230 V, 50/60 Hz)

U8498288-230

Function Generator SG10 (115 V, 50/60 Hz)

U8498288-115

Sine Wave Generator

Sine wave generator with power output up to 16 W in a frequency range from 1 Hz to 100 kHz. The apparatus contains a preamplifier, which can be used in isolation (e.g. as a microphone amplifier) or with a power output stage connected downstream as a broadband amplifier (0 up to 100 kHz).

Sine wave generator with power output:

Frequency range: 1 Hz – 100 kHz, in 5 decadic stages, scale with linear division

Frequency deviation: <5 %

Output voltage: 0 – 6 V, adjustable

Max. output current: 10 A, short circuit proof

Max. output power: 16 W constant, 30 W temporary

Input impedance: 100 kΩ

Preamplifier:

Gain factor: 1 – 300, continuously adjustable

Input: AC coupled, with switchable microphone voltage

Max. output voltage: 10 V_{pp}

Max. output current: 15 mA, short circuit proof

Output impedance: 1 kΩ

Power amplifier:

Voltage gain: 8.5

Operating voltage: 12 V AC

Dimensions: approx. 160x160x50 mm³

Weight: approx. 1.1 kg

U8533550

Additionally required:

U8475470-230 Transformer 12 V, 25 VA (230 V, 50/60 Hz)

or

U8475470-115 Transformer 12 V, 25 VA (115 V, 50/60 Hz)

U8533550





U22065

Two-Channel Function Generator, 20 MHz

Incorporating DDS (Direct Digital Synthesis) technology, this real, two-channel function generator generates stable, highly precise signals with low distortion. Waveforms can be selected in standard form with variable parameters including frequency, amplitude, offset and phase, or edited freely. Numerous modulation types are implemented. A frequency meter is integrated.

Channels:	2 independent channels with adjustable phase
Frequency range:	1 μ Hz...20 MHz (sine)
Standard signals:	Constant, sine, rectangular, ramp, pulse, exponential rise / fall, sync, white noise
Editable signals:	48 pre-configured forms (100 MSa/s, 14-bit vertical accuracy)
Modulation:	Amplitude (AM), frequency (FM), phase (PM), frequency shift keying (FSK), sweep, burst
Display:	LCD, 256 pixels x 64 pixels, 4 grey stages, graphic and alphanumeric
Frequency meter:	100 mHz to 200 MHz
Outputs:	Signals, synchronization signal, external modulation signal
Inputs:	External modulation signal, external 10-MHz signal, external trigger signal
Interface configurations:	USB device, USB host
Supply voltage:	100 – 240 V, 50/60 Hz
Dimensions:	approx. 230x110x290 mm ³
Weight:	approx. 2.7 kg

U22065

Oscilloscope Probe, 100 MHz

Probe to extend the voltage measurement range of any standard commercial oscilloscope. A changeover switch allows selection of bandwidth. The device includes a channel identification terminal, spring-loaded terminal connection, ground lead, insulating cover tip, measuring tip, special tip for IC measurements, trimmer key and BNC adaptor.

Bandwidth:	DC to 100 MHz (1:10), DC to 6 MHz (1:1)
Input resistance:	10 M Ω (1:10), 1M Ω (1:1)
Input capacitance:	16 pF (1:10), 90 pF (1:1)
Max. measuring voltage:	600 VDC, 600 VAC
Connection:	BNC plug
Cable length:	approx. 1.20 m

U11800



U11230-230

Function Generator 0.02 Hz – 2 MHz (230 V, 50/60 Hz)

Multifunctional function generator with four different functions in a single device: function generator, sweep generator, pulse generator and 50 MHz frequency meter.

Frequency range:	0.02 Hz – 2 MHz in 7 ranges
Accuracy:	$\pm 5\%$
Waveform:	Sine, square, triangle, pulse, saw-tooth, ramp
Signal outputs:	
Output voltage:	0 – $\pm 5 V_{PP}$
Output impedance:	50 $\Omega \pm 5\%$
Attenuator:	0 – 20 dB continuously adjustable and 20 dB fixed
Sinusoidal:	Ripple factor <1% (0.2 Hz – 100 kHz)
Square-wave:	Rise time <120 ns
Triangular:	Linearity error <1% (0.2 Hz – 100 kHz)
Rise time TTL:	<25 ns
Rise time CMOS:	<140 ns (max.)
Pulse duty factor:	1:1 – 10:1
Sweep generator:	
Sweep generator:	internal or external, linear
Sweep frequencies:	0.02 Hz – 2 MHz (7 ranges)
Sweep time:	20 ms – 2 s
Frequency meter:	
Frequency range:	200 mHz – 50 MHz
Accuracy:	5% of reading ± 1 Digit
Max. input voltage:	250 V _{PP}
Input impedance:	890 Ω
Display:	6-digit LED
Supply voltage:	230 V, 50/60 Hz
Dimensions:	approx. 280x240x90 mm ³
Weight:	approx. 2 kg

U11230-230

Analogue Oscilloscope, 1x10 MHz (230 V, 50/60 Hz)

Analogue single channel oscilloscope with all the functions and possible display modes of conventional dual beam analogue oscilloscopes. With a bandwidth of 10 MHz, this is a high performance device which is easy to operate, even for inexperienced users.

U11234-230

Additionally recommended:

U11800 Oscilloscope Probe 100 MHz

U11234-230



Analogue Oscilloscope, 2x20 MHz (230 V, 50/60 Hz)

Robust, easy-to-operate dual channel oscilloscope with a bandwidth of 20 MHz. Includes 2 adaptors and 2 BNC/4-mm safety plug connector cables.

U33070-230

Additionally recommended:

U11800 Oscilloscope Probe 100 MHz

U33070-230



Analogue Oscilloscope, 2x30 MHz

Microprocessor controlled analogue oscilloscope for the display of rapid periodic signals. With SMART AUTOSET for both channels, which reproduces the last configuration used when the device is switched back on.

U11175

Additionally recommended:

U11800 Oscilloscope Probe 100 MHz

U11175



	-U11234-230	-U33070-230	-U11175
Vertical deflection			
Operation modes	CH1, XY	CH1, CH2, -CH2, DUAL (ALT/CHOP) ADD, XY	CH1, CH2, -CH2, ALT, CHOP, ADD, XY
Bandwidth	10 MHz	20 MHz	30 MHz
Rise time	≤ 35 ns	≤ 17.5 ns	< 11.7 ns
Deflection coefficient	5 mV/div. – 5 V/div., 10 steps	5 mV/div. – 20 V/div., 12 steps	5 mV/div. – 20 V/div., 12 steps
Accuracy.	±3%	±3%	±3%
Input impedance	1 MΩ ±3% // 25 pF ±5 pF	1 MΩ // 25 pF	1 MΩ // 25 pF
Horizontal deflection			
Time coefficient	100 ns/div. – 100 ms/div., 19 steps	200 ns/div. – 500 ms/div., 20 steps	50 ns/div. – 200 ms/div., 21 steps
Accuracy	±3%	±5%	±3%
Enhancement	---	up to 10 ns/div.	up to 10 ns/div.
Accuracy	---	±10%	±5%
Triggering			
Operation mode	Auto, Normal, TV	Auto, Normal, TV-V, TV-H	Auto, Normal, TV
Trigger source	Y INPUT, LINE, EXT	CH1, CH2, ALT, LINE, EXT	CH1, CH2, ALT, LINE, EXT
Trigger coupling	DC	AC	DC, AC, LFR, HFR, TVV, TVH
Data			
Screen size	48x60 mm ²	80x100 mm ²	80x100 mm ²
Supply voltage	230 V, 50/60 Hz	230 V, 50/60 Hz	94 – 264 V, 48 – 440 Hz
Dimensions	approx. 278x215x85 mm ³	approx. 435x330x160 mm ³	approx. 435x330x163 mm ³
Weight	approx. 3 kg	approx. 5.5 kg	approx. 5.5 kg



U22060

Digital Oscilloscope 4x 70 MHz

Capable of simultaneously displaying four independent channels in colour, this digital oscilloscope offers the following functions: Storage and recall of measured signals, automatic measurement of up to 22 parameters, mathematical operations including fast Fourier transformation, delayed sampling, digital filtering. Including four probes, software and USB cable.

Inputs:

- Coupling: DC, AC, GND
- Impedance: $1\text{ M}\Omega \pm 2\%$
- Capacitance: $18\text{ pF} \pm 3\text{ pF}$
- Probe attenuation factors: 0.001x – 1000x
- Maximum input voltage: $100\text{ V}_{\text{rms}}, 1000\text{ V}_{\text{pp}}$ (in CAT II)
- Mathematical operations: FFT, +, -, *

Vertical deflection:

- Deflection coefficient: 2 mV/div. – 10 V/div., 12 stages
- Offset range: $2 \pm 40\text{ V}$ ($245\text{ mV/div.} \sim 10\text{ V/div.}$)
 $\pm 2\text{ V}$ ($2\text{ mV/div.} \sim 245\text{ V/div.}$)
 $\pm 4\%$ ($2\text{ mV/div.} - 5\text{ mV/div.}$)
 $\pm 3\%$ ($10\text{ mV/div.} - 10\text{ V/div.}$)
- Accuracy: $\pm 4\%$ ($2\text{ mV/div.} - 5\text{ mV/div.}$)
 $\pm 3\%$ ($10\text{ mV/div.} - 10\text{ V/div.}$)
- A/D converter: 8-bit resolution
- Bandwidth: 70 MHz
- Rise time: <5 ns

Horizontal deflection:

Time coefficient: 5 ns/div. – 50 s/div., 31 stages

Trigger:

Trigger sensitivity: 0.1 div. – 1.0 div., adjustable
Trigger threshold: $\pm 6\text{ div.}$ (internal),
 $\pm 1.2\text{ V}$ (EXT),
 $\pm 6\text{ V}$ (EXT/5)

Trigger hold-off: 100 ns – 1.5 s

Operating mode: Edge, pulse width, video, pattern and alternate trigger

Cursor measurements:

- Manual: Voltage difference, time difference, reciprocal time difference
- Track: Voltage values for Y-axis
Time values for X-axis
- Automatic: On-line

Automatic measurement:

Measurement variables: $V_{\text{pp}}, V_{\text{amp}}, V_{\text{max}}, V_{\text{min}}, V_{\text{top}}, V_{\text{base}}, V_{\text{avg}}, V_{\text{rms}}$
Overshoot, Preshoot, Freq, Period, Rise Time, Fall Time, +Width, -Width, +Duty, -Duty, Delay A→B+, Delay A→B-, Phase A→B+, Phase A→B-

General data:

- Display: TFT-LCD, 5.7 inches, 320 pixels x 240 pixels, 64 k colours
- Memory: 16 k
- Interface configurations: USB device, dual USB host
- Supply voltage: 100 – 240 V, 50/60 Hz
- Dimensions: approx. $325 \times 160 \times 135\text{ mm}^3$
- Weight: approx. 3 kg

U22060



U112491

USB Oscilloscope 2x50 MHz

Meant for connection to a PC with USB ports, this two-channel USB oscilloscope comes with a USB cable as well as Windows software. On being connected to a PC, the digital storage oscilloscope not only offers a wide spectrum of features but also the added advantage of being able to save measured data and process them further, for example, for purposes ranging as far as FFT analysis. The monitor's surface is modelled after that of a conventional oscilloscope. Operation is facilitated by an auto-set function for automatic adaptation to measuring signals and numerous trigger functions.

- Channels: Two
- Operating modes: CH1, CH2, X/Y
- Sampling rate: 150 MS/s
- Input coupling: DC, AC, GND
- Input impedance: $1\text{ M}\Omega \parallel 50\text{ pF}$
- Input voltage: 0 – 35 V
- Deflection coefficient: 10 mV/div. – 5 V/div.
- Accuracy: $\pm 3\%$
- A/D converter: 8-bit resolution
- Bandwidth: 50 MHz
- Time coefficient: 4 ns/div. – 1 h/div.
- Roll mode: 1 s/div. – 1 h/div.
- Trigger: Auto/Normal/Single/Ext.
- Calibrator: 1 kHz/ 2 Vpp
- Memory depth: 10 – 64 kpts
- Interface: USB 2.0
- Voltage supply: Via two USB ports
- Dimensions: $205 \times 38 \times 125\text{ mm}^3$
- Weight: 430 g
- Windows: 98SE/ ME/ 2000/ XP/ Vista™/ Windows® 7
- Analysis options: LabVIEW® compatible, data transfer to spreadsheet programs

U112491

Advantages

- Easily portable, low-weight, built-in fold-out handle
- High performance and a multitude of data acquisition and analysis functions
- Three ways of recording data in two separate modes: real-time or time-equivalent
- Simple MATHS functions: \pm , \sqrt{x} , $\frac{1}{x}$ and FFT functions in real time with simultaneous display of curves
- Built-in test overlay with Pass/Fail display for rapid testing of signals
- Optimised signal analysis
- Fast saving of measurement curves to USB Stick via USB HOST interface
- USB and serial ports for connection to a computer
- EASYSCOPE software makes it possible to operate the equipment from a PC, allowing function tests and saving of curve data and screenshots to computer.



U11165

Digital-Oszilloskope

Modern and easy-to-use digital oscilloscopes in space-saving case with large screen and colour display. Includes two voltage probes, USB A/B connection lead, CD with EASYSCOPE PC software.

Digital Oscilloscope, 2x 25 MHz

U11165

Digital Oscilloscope, 2x 40 MHz

U11166

Digital Oscilloscope, 2x 100 MHz

U11167

	U11165	U11166 / U11167
Vertical deflection		
Channels	Two	Two
Band width	25 MHz	40 MHz / 100 MHz
Rise time	<14 ns	<8 ns / 3,5 ns
Deflection coefficient	2 mV/div. – 10 V/div., 12 levels	2 mV/div. – 10 V/div., 12 levels
Precision	±3%	±3%
Input impedance	1 MΩ // 18 pF	1 MΩ // 18 pF
Horizontal deflection		
Time coefficient	25 ns/div. – 50 s/div.	2,5 ns/div. – 50 s/div.
Scan or roll modes	100 ms/div. – 50 s/div.	100 ms/div. – 50 s/div.
Trigger		
Trigger source	CH1, CH2, Ext, Ext/5, mains	CH1, CH2, Ext, Ext/5, mains
Trigger mode	Automatic, triggered, single-shot – X/Y	Automatic, triggered, single-shot – X/Y
Roll mode	100 ms/div. – 50 s/div.	100 ms/div. – 50 s/div.
Trigger resolution	Edge, pulse width (20 ns – 10 s), video (PAL, Secam, NTSC), gradient, alternating, HOLD OFF 10 ns – 1.5 s	Edge, pulse width (20 ns – 10 s), video (PAL, Secam, NTSC), gradient, alternating, HOLD OFF 10 ns – 1.5 s
Trigger coupling	AC, DC, HFR (HF suppression), LFR (LF suppression)	AC, DC, HFR (HF suppression), LFR (LF suppression)
Digital memory		
Max. sampling rate	Single-shot 250 MS/s (2 channels), 500 MS/s (1 channel), repeating signals 10 GS/s	Single-shot 500 MS/s (2 channels), 1 GS/s (1 channel), repeating signals 50 GS/s
Vertical resolution	8 Bit	8 Bit
Memory depth	Internal memory up to a maximum of 32K points, "unlimited" memory if using USB sticks	Internal memory up to a maximum of 2 M points (long MEM), "unlimited" memory if using USB sticks
User memory	2 MB for data storage: curves, text, configurations, Maths function, print files, image data etc.	2 MB for data storage: curves, text, configurations, Maths function, print files, image data etc.
System requirements	up to Windows 8, 64 Bit	up to Windows 8, 64 Bit
General data		
Display	7" TFT LCD colour screen, resolution 480x234 pixels	7" TFT LCD colour screen, resolution 480x234 pixels
Mains voltage	100 – 240 V, 50/60 Hz	100 – 240 V, 50/60 Hz
Dimensions	320x150x135 mm approx.	320x150x135 mm approx.
Weight	approx. 2.4 kg	approx. 2.4 kg



Art. No.	Designation	Meas. ranges	Scale division	Internal resistance
U11810	Ammeter, DC	50 mA, 500 mA, 5,0 A	1 mA, 10 mA, 0.1 A	10 Ω
U11811	Voltmeter, DC	3.0 V, 15 V, 300 V	0.1 V, 1 V, 10 V	1 kΩ/V
U11812	Ammeter, AC	1.00 A, 5.0 A	0.02 A, 0.1 A	Rectifier
U11813	Voltmeter, AC	15.0 V, 150 V	0.5 V, 5 V	Rectifier
U11814	Galvanometer, DC	±35 μA	1 μA	1000 Ω

Measuring Instruments for Student Use

Sturdy pointer instruments for measuring current or voltage. In shock proof desktop housings. Built especially for student and practical lab experiments. With moving coil instruments, mirror scale and 4 mm safety sockets.

Accuracy: class 2.0
 Dimensions: approx. 90x106x103 mm³

Analogue Multimeter AM50

Hand held multimeter for measuring voltage and current for a wide range of applications in student and practical experiments. A heavy duty device with excellent overload protection, zero point of scale centre or left and automatic battery cut off after approx. 45 minutes.

Measuring ranges:
 Direct voltage: 100 mV–300 V, 8 steps
 Alternating voltage: 3 V–300 V, 5 steps
 Direct current: 0.1 mA–3 A, 6 steps
 Alternating current: 0.1 mA–3 A, 6 steps
 Internal resistance: 10 MΩ
 Scale zero-point: Centre/left
 Accuracy: class 2 (DC) / class 3 (AC)
 Supply voltage: 1x 9 V battery
 Dimensions: approx. 98x138x35 mm³
 Weight: approx. 0.3 kg

U17450

Analogue Multimeter AM51

Low price hand held multimeter for measuring current, voltage and resistance. For universal use in student experiments and practicals.

Measuring ranges:
 Direct voltage: 100 mV–600 V, 7 steps
 Alternating voltage: 10 V–600 V, 5 steps
 Direct current: 50 μA–1 A, 5 steps
 Alternating current: 3 mA–3 A, 4 steps
 Resistance: Ωx1/ 10/ 100
 Internal resistance: 20 kΩ/V (DC) / 6.67 kΩ/V (AC)
 Scale zero-point: left
 Accuracy: class 2.5
 Supply voltage: 1x 1.5 V battery
 Dimensions: approx. 98x138x35 mm³
 Weight: approx. 0.25 kg

U17451

Zero Point Galvanometer CA 403

Reasonably priced, sturdy and easy to use analogue measuring instrument with moving coil instrument and rectifier, particularly well suited for student and practical experiments, may be used as a DC microammeter and DC millivoltmeter. This device has only one control knob, includes safety sockets and quick break fuses, is electrically protected and double insulated.

Measuring ranges: 100 mV DC, 30 μA DC, 3 mA DC
 Internal resistance: 3333 Ω, 460 Ω, 500 Ω
 Accuracy: ±1.5%
 Zero point: centre
 Mirrored scale: yes
 Connection: 4 mm security sockets
 Fuse: 0.315 A HBC 380 V 50 kA
 Dimensions: approx. 165x105x50 mm³
 Weight: approx. 450 g

U11170



U17450



U17451



U11170

Advantages

- Unmistakeable measurement readings
- Only an inexpensive 1.5-V battery element is needed for operation
- Full functionality guaranteed even when the battery is no longer fully charged
- Lithium batteries with higher open-circuit voltage can also be used
- Battery protected by automatic cut-off after approximately 50 mins.
- Distinct difference between 0 V display and the equipment being switched off due to inherently different position of needle



U8557330



U8557380

No need to change fuses

CAT III, 600 V

The ideal meter for student experiments: Analogue Multimeters ESCOLA

Clear moving-coil instrument in shock-resistant plastic casing with two mirrored linear scales and clearly distinguishable measuring ranges. Includes battery test function and display of charge status as well as electronic calibration of zero point to the centre of the scale for all DC current and voltage ranges. Use of a measurement amplifier ensures the measured values are linear even for AC voltages of up to 40 kHz. Only an inexpensive 1.5 V battery element is needed for operation. Nevertheless the meter will work for several years after any change of battery with normal usage, since the current discharge when in operation is no more than 2.5 mA maximum.

Scale length:	80 mm
Operating voltage:	1 – 3.5 V DC
Battery type:	Mignon, AA, R6
Accuracy:	Class 2 (DC), class 3 (AC)
Dimensions:	approx. 100x150x50 mm ³
Weight:	approx. 300 g

Analogue Multimeter ESCOLA 30

Permanently short-circuit-proof student measuring instrument for measuring voltage and current in the safety extra-low voltage range. The electronic overload protection is achieved without the use of an equipment fuse, therefore obviating any need to change fuses or order spares. The protective system nevertheless operates without any auxiliary energy and is guaranteed even when the battery is flat or no battery is present.

Direct and alternating voltage:	0.3 – 30 V, 5 ranges each
Direct and alternating current:	1 – 3000 mA, 5 ranges each
Instrument category:	CAT I, 30 V

U8557330

Note:

Electrical safety of measuring instruments for current and voltage are assessed according to measurement categories stipulated in IEC 611010-1:

CAT I or unstipulated: Approved for measurements in circuits which are not directly connected to the low voltage mains grid (e.g. batteries).

CAT II: Approved for measurements in circuits which are directly connected, by a mains lead and plug for instance, to the low voltage mains grid (e.g. household or office appliance and lab equipment).

CAT III: Approved for measurements in circuits which are part of a building's wiring installation (e.g. stationary consumers, distribution terminals, appliances connected directly to the distribution box).

CAT IV: Approved for measurements in circuits which are directly connected to the source of the low voltage mains (e.g. electricity meters, main service feed, primary excess voltage protection).

N.B.: the closer measurement is to be made to the low-voltage mains installation, the higher the measuring category needs to be.

Analogue Multimeter ESCOLA 100

Meter for classroom and practical experiments to measure voltage and current up to 600 V or 10 A respectively. Also features audible continuity testing. Includes a fuse to guarantee safety up to CAT III. The separate terminal sockets for current and voltage permit connection of the instrument that allows for current as well as voltage to be measured without having to reconnect the measuring leads. When switching from one measuring range to another, the circuit is never broken. All current measuring ranges are overload-proof for long-term current of up to 10 A. The generous protection of all current measuring ranges by means of additional semiconductor protection prevents inadvertent blowing of the fuse in many cases.

Direct and alternating voltage:	0.1 – 600 V, 9 ranges each
Direct and alternating current:	0.1 mA – 3000 mA, 11 ranges each
Internal resistance:	1 MΩ
Long term maximum voltage:	600 V
Instrument category:	CAT III, 600 V (DIN EN 61010-1:2010, 61010-2-033:2012)

U8557380

Tested safety

With automatic cut-off



U118071



U11806



U118091

Digital Mini Multimeter

Very reasonably priced mini multimeter in pocket format for measuring voltage, DC current, resistance and temperature and also including diode and continuity tests. Overload protection for mA ranges, 10 amp range is unprotected. Includes measuring leads, type K thermocouple and battery.

- DC voltage: 200 mV–250 V, 5 ranges, $\pm 0.8\%$ ± 2 digits
- AC voltage: 200/ 250 V, 2 ranges, $\pm 1.2\%$ ± 10 digits
- DC current: 200 μ A–10 A, 5 ranges, $\pm 1.0\%$ ± 2 digits
- Resistance: 200 Ω –2000 k Ω , 5 ranges, $\pm 0.8\%$ ± 2 digits
- Temperature: 0–1000°C, $\pm 2.0\%$ ± 3 digits
- Display: 3½ digit LCD, 12 mm, max: 1999
- Operating voltage: 9 V battery
- Safety classification: CAT II 250 V (IEC-1010-1)
- Dimensions: approx. 70x140x30 mm³
- Weight: approx. 210 g

U118071

Digital Multimeter P1035

Compact 3½ digit multimeter for measuring voltage, current and resistance and also including diode and continuity tests. Complete with pouch, leads and battery.

- DC voltage: 200 mV–600 V, 5 ranges, $\pm 0.5\%$ ± 2 digits
- AC voltage: 200/ 600 V, 2 ranges, $\pm 1.2\%$ ± 10 digits
- DC current: 2000 μ A–10 A, 4 ranges, $\pm 1\%$ ± 2 digits
- Resistance: 200 Ω –2000 k Ω , 5 ranges, $\pm 0.8\%$ ± 2 digits
- Display: 3½ digit LCD, 27 mm, max: 1999
- Operating voltage: 9 V battery
- Safety classification: CAT III 600 V (IEC-1010-1)
- Dimensions: approx. 70x150x48 mm³
- Weight: approx. 260 g

U11806

Digital Multimeter P3340

Digital multimeter for universal use in measuring voltage, current, resistance, frequency, capacitance, temperature and also including diode and continuity tests. Includes a measurement value hold function, analogue bar graphs, automatic polarity reversing, overload and overvoltage protection as well as an acoustic overload indicator, automatic switch off. Device comes in a shock-proof holster with fold-out stand. Including testing leads, type K temperature sensor and batteries.

- DC voltage: 400 mV–1000 V, 5 ranges, $\pm 0.5\%$ ± 2 digits
- AC voltage: 4–700 V, 4 ranges, $\pm 1.2\%$ ± 3 digits
- DC current: 400 μ A–10 A, 6 ranges, $\pm 1\%$ ± 3 digits
- AC current: 400 μ A–10 A, 6 ranges, $\pm 1.5\%$ ± 5 digits
- Resistance: 400 Ω –40 M Ω , 6 ranges, $\pm 1\%$ ± 2 digits
- Capacity: 40 nF–100 μ F, 5 ranges, $\pm 3\%$ ± 5 digits
- Temperature: -20–760°C, $\pm 3\%$ ± 3 digits
- Display: 3¾ digit LCD, 39 mm, max: 3999
- Operating voltage: 9 V battery
- Safety classification: CAT II 1000 V (IEC-1010-1)
- Dimensions: approx. 92x195x38 mm³
- Weight: approx. 200 g

U118091

True
RMS

USB



U118082



U8531050



U118241

Digital Multimeter P3320

Digital multimeter for universal use in measuring voltage, current, resistance, frequency, capacitance and temperature. With real time rms measurement feature and backlighting. 3⁵/₆ digit LCD display with function symbols and analogue bar graphics. Automatic and manual range selection. With non-contact voltage detector. Includes measuring leads, type K thermocouple, shock resistant pouch and battery.

DC voltage:	600 mV–1000 V, 5 ranges, $\pm 1.2\%$ ± 2 digits
AC voltage:	6 V–1000 V, 4 ranges, $\pm 1.5\%$ ± 10 digits
DC current:	6 A–10 A, 2 ranges, $\pm 2.5\%$ ± 5 digits
AC current:	6 A–10 A, 2 ranges, $\pm 3\%$ ± 5 digits
Resistance:	600 Ω –60 M Ω , 6 ranges, $\pm 1\%$ ± 2 digits
Capacity:	40 nF–4000 μ F, 6 ranges, $\pm 5\%$ ± 5 digits
Frequency:	10 Hz–10 MHz, 7 ranges, $\pm 1.2\%$ ± 3 digits
Temperature:	-20–760°C, $\pm 3\%$
Display:	3 ⁵ / ₆ digit LCD, 19 mm, max: 3999
Operating voltage:	9 V battery
Safety classification:	CAT III 600 V / CAT II 1000 V (IEC-1010-1)
Dimensions:	approx. 70x150x48 mm ³
Weight:	approx. 260 g

U118082

Digital Multimeter E

Compact 3¹/₂-digit multimeter for measuring voltage, current and resistance as well as for diode and hFE gain testing. Overload protection in μ A/mA range but no protection for 20-A range. Folding digital display. Includes measuring leads and battery.

DC voltage:	200 mV–1000 V, 5 ranges, $\pm 0.5\%$ ± 1 digit
AC voltage:	200 mV–750 V, 5 ranges, $\pm 0.8\%$ ± 3 digits
DC current:	20 μ A–20 A, 7 ranges, $\pm 0.8\%$ ± 1 digit
AC current:	20 μ A–20 A, 7 ranges, $\pm 1.0\%$ ± 3 digits
Resistance:	200 Ω –20 M Ω , 6 ranges, $\pm 0.8\%$ ± 1 digit
Display:	3 ¹ / ₂ display LCD, 24 mm, max. 1999
Operating voltage:	9-V-battery 6F22
Dimensions:	approx. 85x185x35 mm ³
Weight:	approx. 230 g

U8531050

Digital Multimeter P3415

This innovative digital multimeter uses an opto-coupled USB cable to connect directly to a computer to allow you to record up to three measurements per second. A wide range of functionalities such as autoranging, relative measurements, and Min/Max/Hold also make this a highly versatile stand-alone tool. Measuring modes include DCV, ACV, DCA, ACA, resistance, diode, continuity, frequency, capacitance and temperature. The unit is supplied with a carrying case, USB cable, Software for Windows 2000/XP/Vista/7, type-K thermocouple, test leads, test clips, battery and operation manual.

DC voltage:	600 mV–1000 V, 5 ranges
AC voltage:	600 mV–700 V, 5 ranges
DC current:	600 μ A–10 A, 6 ranges
AC current:	600 μ A–10 A, 6 ranges
Resistance:	600 Ω –60 M Ω , 6 ranges
Frequency:	100 Hz–1 MHz, 5 ranges
Capacity:	60 nF–300 μ F, 5 ranges
Temperature:	-55°C–1000°C, 2 ranges
Display:	3 ⁵ / ₆ digit LCD, 18 mm
Operating voltage:	9 V battery (included)
Safety classification:	CAT III 1000 V / CAT IV 600 V (IEC-1010-1)
Dimensions:	90x190x40 mm ³ approx.
Weight:	500 g approx.

U118241



U11276



U11275



U11277

DMM Digital Multimeter

Digital multimeter for conducting measurements in situations where a high degree of safety needs to be assured. Automatic blocking of sockets (ABS), which are not used for specific functions. Back-lit liquid crystal display with digital read-out and analogue bar chart scale. Economy mode with automatic shut-off after 10 minutes without the measured reading changing. Excess voltage and overload warning, automatic or manual range selection, data storage and maximum and minimum functions. Supplied with measurement leads, 9-V block battery, spare fuse, English instructions, test report and impact-resistant protective case with stand legs and carrying strap.

Measured variables and ranges:

- DC voltage: 30.00 mV (10 μ V) – 1000 V (1 V), 6 ranges $\pm 0.25\% \pm 1$ digit
- AC voltage: 3.000 V (1 mV) – 1000 V (1 V), 4 ranges $\pm 0.75\% \pm 1$ digit
- Direct current: 300.0 μ A (100 nA) – 10.00 A (10 mA), 6 ranges $\pm 1.00\% \pm 2$ digits
- Alternating current: 3.000 mA (1 μ A) – 10.00 A (10 mA), 4 ranges $\pm 1.50\% \pm 2$ digits
- Resistance: 30.00 Ω (10 m Ω) – 30.00 M Ω (10 k Ω), 7 ranges
- Capacitance: 30.00 nF (10 pF) – 30.00 μ F (10 nF), 4 ranges
- Frequency: 300.0 Hz (0.1 Hz) – 100.0 kHz (100 Hz), 4 ranges

Other variables:

- Duty cycle: 2.0% – 98.0%
 - Temperature*: -200.0 $^{\circ}$ C – +850.0 $^{\circ}$ C (Pt 100)
-100.0 $^{\circ}$ C – +850.0 $^{\circ}$ C (Pt 1000)
 - Continuity test: Yes
 - Diode test: 2 V
- * Sensors available on request

Other data:

- Safety category: CAT III 1000 V (IEC 61010-1:2001)
CAT IV 600 V (IEC 61010-1:2001)
- Dimensions: 200x80x30 mm³
- Weight: 700 g approx.

DMM50 Digital Multimeter

Digital multimeter without true RMS (TRMS) measurement capability.

U11276

DMM60 Digital Multimeter

Digital multimeter with true RMS (TRMS) measurement capability for distorted input signals.

U11275

DMM 1000 Iso-Multimeter

Digital multimeter with integrated insulation resistance measuring capability for voltages from 50 V to 1000 V and additional measuring functions for testing AC and DC voltage and current, resistance, capacitance, frequency and temperature plus diode testing. Automatic blocking of sockets (ABS), which are not used for specific functions. Automatic shut-off, excess voltage and overload warning, true RMS (TRMS) measurement capability for distorted input signals. Back-lit liquid crystal display with digital read-out and analogue bar chart scale. Supplied with English instructions and impact-resistant protective case with stand legs.

- Safety category: CAT II 1000V
CAT III 600 V

U11277

Sound Level Meter P5055

Universally deployable digital meter used to determine the sound level of any number of acoustic sources across a wide sound range. Device is housed in a robust plastic casing with integrated calibration signal and large LCD display for easy reading of measured values. Includes range selection switch and maximum hold function. There are two evaluation levels (A and C) available for the frequency. The measurement in the A-range is oriented on the human ear and is particularly well suited for measurements out in the open, while the C-range is designed for measurements of motor noise. The device's response time can be adjusted between fast and slow. The slow mode brings about attenuation of the measurement i.e. the measured value displayed corresponds to the average sound level. Fast mode is used to measure brief noise sequences and to determine the maximum noise level. Furthermore, the device also offers the option of connecting an external measuring instrument (e.g. for compiling and printing out measurement sequences) via an analogue output (phone jack). On the underside of the sound level meter there is a drill hole for attaching to a stand. Supplied in a foam lined portable bag.

Measurement range:	35 – 130 dB
Resolution:	0.1 dB
Accuracy:	±3.5 dB at 94 dB (1kHz)
Display:	3½-digit LCD display
Digit height:	17 mm
Microphone:	Electret capacitor microphone
Power supply:	9 V block-type battery
Dimensions:	251x64x40 mm ³ approx.
Weight:	250 g approx.

U11801

Digital Energy Meter

Digital meter for measuring consumption of electrical energy by appliances connected to the mains and for determining bills given a rate for kilowatts per hour. It is also possible to demonstrate stand-by operation for larger appliances. If the connected appliance consumes more than 3600 W a warning signal is emitted. Supplied with an internal battery for memory back-up.

Values displayed:	Energy, costs incurred, power, voltage, current, time, day of the week
Input voltage:	230 V, 50/60 Hz
Maximum permitted load:	3680 W/16 A
Minimum load for display:	1 W/0.005 A
Energy:	0.00 – 9999.99 kWh
Current:	0 – 16 A
Active power:	1 – 3680 W
Accuracy:	±1%
Safety classification:	Cat II 300 V (IEC-1010-1)
Operating voltage:	internal battery for memory back-up
Dimensions:	128x64x78 mm ³
Weight:	170 g

U118261-230

Digital Luxmeter

Reasonably priced, easy to use pocket luxmeter for testing and measurement of light conditions. C.I.E. standard spectrum. Including light sensor, pouch and battery.

Measuring ranges:	200 – 50000 lux, 4 ranges, ±5%
Operating voltage:	Battery
Dimensions:	approx. 65x115x25 mm ³
Weight:	approx. 160 g

U11803

Noise Level Meter P8005

Digital noise level meter with circuit for suppressing background noise for measuring all types of sound levels in the environment, including noise levels in schools, offices, factories, traffic noise, household noise or for noise-reduction projects. Allows for manual or automatic selection of levels and measurements of minimum and maximum levels. Thanks to its built in USB port, the supplied 9 V mains adaptor and stand, it is also suitable for permanent or long term measurement. Includes case, USB cable, Windows software, stand, 9 V mains adaptor, 9 V battery and instruction manual.

Digital display:	4 digit LCD
Height of digits:	20 mm
Multi-functions display:	58x44 mm ²

Digital display of measurement, measuring time, bar graphs plus overs and unders

Background lighting:	blue
Applicable standards:	IEC-61672-1 type 2, ANSI S1.4 type 2
Frequency range:	31.5 Hz – 8 kHz
Dynamic range:	50 dB
Level ranges:	30 – 80 dB (low) 50 – 100 dB (medium) 80 – 130 dB (high) 30 – 130 dB (automatic)

Resolution:	0.1 dB
Precision:	±1.4 dB
Response times:	125 ms (fast), 1s (slow)
Microphone:	½-inch, with electret capacitor
Display update:	Twice a second
Analogue output:	AC/DC
Operating voltage:	9 V battery or 9 V mains adaptor
Dimensions:	90x280x50 mm ³ approx.
Weight:	350 g approx.

U11804





U8533341-230
U8533341-115

Digital Counter

Digital counter/timer for measuring duration of motion, transition times, periods, pendulum periods and frequencies, as well as for counting events or Geiger tube pulses. Includes a speaker that can be turned on and off, power supplies for direct connection to light barriers (U11365) or for powering a Geiger-Müller counter (U8533430). For event counting, a fixed counting period can be programmed in a range from 1 s to 99999 s. Counter events (start, stop) can either be triggered by a signal to the input sockets or manually via switches. Includes plug in power supply.

Time measurement:	0.1 ms – 99999 s
Resolution:	0.1 ms / 1 ms / 0.1 s
Frequency measurement:	1 – 100 kHz, where voltage > 1.5 V _{pp}
Resolution:	1 mHz (1 – 100 Hz), 1 Hz (1 – 100 kHz)
Counting periods:	1/10/60 s or manually triggered
Input A:	miniDIN 8 socket, 4 mm safety sockets
Input B:	miniDIN 8 socket, 4 mm safety sockets
Input voltage A:	0.5 V – 15 V AC
Input voltage B:	1 V – 15 V AC
Active edge:	Rising/falling
Counter tube input:	BNC socket
Power supply:	550 V / 1 MΩ
Display:	5 digit LED display
Operating voltage:	9 – 12 V DC via plug in power supply
Dimensions:	250x100x160 mm ³ approx.
Weight:	0.8 kg approx.

Digital Counter (230 V, 50/60 Hz)

U8533341-230

Digital Counter (115 V, 50/60 Hz)

U8533341-115



U8533341-230
U8533341-115

U8533430

U8611210



U8533341-230
U8533341-115

U11365

U8611210



U8533341-230
U8533341-115

U8400830

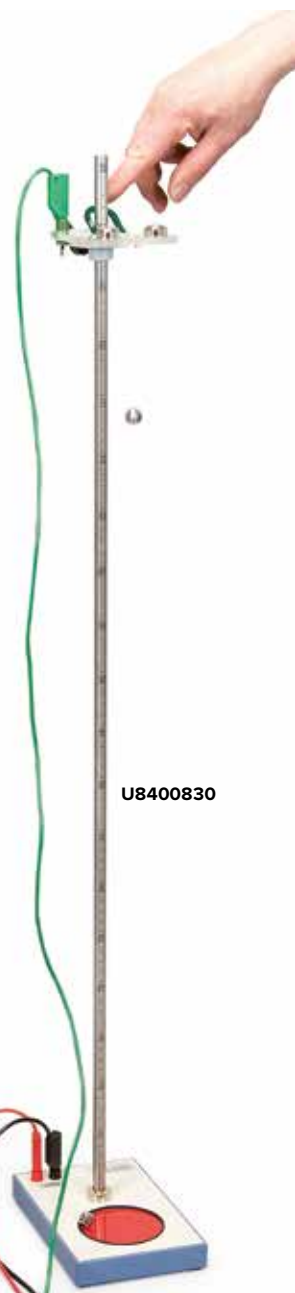



U210051-230
U210051-115



U8533370-230
U8533370-115

Digital Counter with Interface

Microprocessor controlled digital counter for measuring duration of motion, transition times, periods, pendulum periods and frequencies, as well as for counting events or Geiger tube pulses. Keyboard operated. With adjustable trigger edge, speaker that can be turned on and off, power supply for direct connection to light barriers (U11365) and adjustable low voltage output for supplying a Geiger-Müller tube (U8533430). With RS 232 interface and supplied cable plus software for graphic depiction of measured data and export to spreadsheet programs.

Frequency (Input A):

Measuring range: 0.01 Hz – 100 kHz
Resolution: 10 mHz – 10 Hz
Type of measurement: Repeated measurement/
single measurement

Period of oscillation (Input A):

Measuring range: 1 ms – 100 s
Resolution: 0.01 – 10 ms
Type of measurement: Repeated measurement/
single measurement

Pulse counting (Input A)/rate

measurement (counter tube input):

Measuring range: 0 – 9999 pulses
Resolution: 1 pulse
Type of measurement: Continuous measurement
Single measurement for counting periods of 1 s, 6 s, 10 s, 60 s, repeated measurement for a period of 10 s

Time for motion between A and B:

Measuring range: 0.01 ms – 100 s
Resolution: 0.01 ms
Start: START/STOP button, pulse at A.
Stop: START/STOP button, pulse at B.

Transition times via A and B:

Measuring range: 0.01 ms – 100 s
Resolution: 0.01 ms
Type of measurement: Simultaneous measurement
at both inputs

Transition time and period of motion:

Measuring range: 0.01 ms – 100 s
Resolution: 0.01 ms
Type of measurement: Time for motion from A to B, time for transition at A, time for transition at B

Input A: BNC socket, miniDIN 8 socket,
two 4 mm safety sockets
Input B: BNC socket, miniDIN 8 socket,
two 4 mm safety sockets

Tube input: BNC socket (on reverse)
Power supply: 300 – 625 V DC, continuously adjustable
Measurement display: 7 segment LED, 4 digit
Height of digits: 20 mm
Function display: LCD with illumination, 2x 16 digit
Computer connection: RS 232
Power consumption: 20 VA approx.
Dimensions: 95x245x185 mm³ approx.
Weight: 5 kg approx.

Digital Counter with Interface (230 V, 50/60 Hz)

U210051-230

Digital Counter with Interface (115 V, 50/60 Hz)

U210051-115

Millisecond Counter

Inexpensive, compact counter for measuring milliseconds, e.g. in conjunction with the free-fall apparatus (U8400830). Each count is started and stopped by a signal at the input sockets. The device is automatically reset to zero each time it is restarted. Includes plug-in power supply.

Time measurement: 1 ms – 9999 s
Supply voltage: 5 V DC
Connectors: 4-mm safety sockets
Dimensions: 105x75x35 mm approx.
Weight: 400 g approx.

Millisecond Counter (230 V, 50/60 Hz)

U8533370-230

Millisecond Counter (115 V, 50/60 Hz)

U8533370-115

Digital Stroboscope

Portable microprocessor-controlled device with quartz-controlled time base for observation of periodic movements, as well as for frequency and rotation speed measurement. Xenon flash tube built into a robust plastic casing with handle and photo thread for mounting on a stand, continuous frequency adjustment in two ranges through coarse and fine setting using control knobs, 4-digit digital display permits readings of the desired flash sequence per minute.

Meas. ranges: 100 min⁻¹ – 1000 min⁻¹ (approx. 1.5 Hz – 18 Hz)
1000 min⁻¹ – 10000 min⁻¹ (approx. 18 Hz – 165 Hz)
Accuracy: ± (0.05% + 1 digit)
Display: 4-digit LED
Resolution: 0.1 min⁻¹ (< 1000 min⁻¹)
1 min⁻¹ (1000 min⁻¹ – 9999 min⁻¹)
10 min⁻¹ (10000 min⁻¹)
Flash duration: 60 µs – 100 µs
Flash energy: 4 Ws
Flash angle: 80°
Dimensions: 210x210x120 mm³ approx.
Weight: 1 kg approx.

Digital Stroboscope (230 V, 50/60 Hz)

U40160-230

Digital Stroboscope (115 V, 50/60 Hz)

U40160-115



U40160-230
U40160-115

Spare Bulb, Stroboscope (not shown)

Spare bulb for the Digital Stroboscope (U40160-230/ U40160-115).

U40161

Teslameter, 200 mT

This economical digital teslameter will allow students to incorporate quantitative measurements into their magnetism experiments. The unit includes a Hall sensor probe for measuring axial and tangential magnetic fields up to 200 mT. The probe also serves as a ruler as it includes a metric scale. There are two measuring ranges, 0 – ±20 mT and 0 – ±200 mT. The teslameter can be calibrated by the user. In addition to having a digital display, the unit outputs a voltage proportional to the magnetic field which can be measured with a data logger, XY-recorder or analogue multimeter.

- Measurement ranges: 0 – ±20 mT, 0 – ±200 mT
- Resolution: 0.01 mT, 0.1 mT
- Digital Display: 3½ digit LCD
- Height of digits: 13 mm
- Input: BNC socket
- Output: 4 mm safety sockets
- Dimensions of unit: 205x230x85 mm³
- Dimensions of probe: 360x15x25 mm³



U33110-230
U33110-115

Teslameter, 200 mT (230 V, 50/60 Hz)

U33110-230

Teslameter, 200 mT (115 V, 50/60 Hz)

U33110-115

Teslameter E

Hand-held meter for measuring magnetic flux density B or magnetic field strength H in conjunction with an axial-tangential field sensor (U8533997) or a flexible magnetic field sensor (U8533999). The measurements are shown on a digital display and also converted into equivalent voltage outputs, which can be accessed from the analogue output connection.

- LCD display: 3½-digit, 10 mm high
- Power supply: Rechargeable 9-V block battery providing about 20 hours of operation
- Sensor connection: DIN socket
- Offset compensation: ±0.150 mT

Measuring modes:

- DC-B Flux B of uniform fields
- AC-B Flux B of alternating fields (1 Hz – 10 kHz)
- AC-H Field strength H of alternating fields (1 Hz – 10 kHz)

Measuring ranges:

- Flux B: ±2.000/±20.00/±200.0/±2000 mT
- Field strength H: ±2.000/±20.00/±200.0/±2000 A/m
- Analogue output: 4-mm socket
- Connector: 4-mm socket
- Range: 0 – ±2 V

U8533982

Additionally required:

U8533997 Magnetic Field Sensor, Axial/Tangential

or

U8533999 Flexible Magnetic Field Sensor

Flexible Magnetic Field Sensor

Flexible magnetic field sensor with built-in Hall sensor for measuring tangential magnetic fields in connection with the E-model teslameter (U8533982).

- Sensitivity: 1 mV/mT
- Length of probe (without handle): 75 mm
- Thickness of probe: 0.6 mm
- Hall sensor: Monocrystalline InAs
- Sensor surface: 1 mm²
- Connection: DIN plug

U8533999

Magnetic Field Sensor, Axial/Tangential

Magnetic field sensor with two built in Hall sensor probes for measuring axial and tangential magnetic fields in conjunction with the teslameter (U8533982). A slider switch provides for switching between axial and tangential measuring modes.

- Sensitivity: 1 mV/mT
- Length of probe (without handle): approx. 125 mm
- Thickness of probe: 4 mm
- Hall sensors: Monocrystalline InAs
- Sensor surface: 1 mm²
- Connection: DIN plug

U8533997



U8533982

U8533997

U8533999

U8532161
Measuring Amplifier S

Measuring amplifier for measuring small voltages and current in conjunction with an ordinary voltmeter in the course of student experiments. Measuring range with reference to 1 V output voltage:

Voltage (AC/DC): 1 mV – 1 V
 Current (AC/DC): 100 nA – 100 μ A
 Frequency range: 0 – 20 kHz ($v = 1$)
 0 – 500 Hz ($v = 1000$)

Input impedance: 10 k Ω
 Input U: BNC socket
 Input I: BNC socket
 Max input voltage: 10 V
 Output: 4 mm safety sockets
 Max output voltage: 10 V
 Limiting frequency: 100 Hz
 Gain factor: 106
 Accuracy: 2 %
 Operating voltage: 12 V AC
 Dimensions: approx. 175x85x65 mm³
 Weight: approx. 250g

U8532161

Additionally required:
U8475470-230 Transformer 12 V, 25 VA (230 V, 50/60 Hz)
 or
U8475470-115 Transformer 12 V, 25 VA (115 V, 50/60 Hz)
U17450 Analogue Multimeter AM50

Microvoltmeter

Measuring instrument and amplifier for measuring very small DC and AC voltages, e.g. thermo-voltages, inductive voltages and photo-electric voltages. With LED display. The measuring input includes a filter that can be switched in for smoothing the signal or for setting an upper frequency limit. The signal is input via a BNC socket or 4 mm safety sockets. An additional DIN socket is provided for the connection of Hall sensors, the axial/tangential magnetic field sensor (U8533997).

Inputs: 4 mm safety sockets, BNC socket, DIN socket
 Outputs: 4 mm safety sockets
 Measuring ranges: 199.9 μ V – 199.9 mV AC /DC, 4 ranges each
 Gain factors: 10 – 10000, 4 decades
 AC frequency range: 10 Hz – 1 kHz
 Input resistance: 100 k Ω (DC), 900 k Ω (AC)
 Upper frequency limit: 1 Hz – 1 kHz, 4 decades
 Precision: 5%
 Sampling rate: 3 measurements/s
 Output signal: 0 – \pm 2 V, max. 1 mA
 Dimensions: approx. 235x250x180 mm³
 Weight: approx. 3.3 kg

Microvoltmeter (230 V, 50/60 Hz)

U8530501-230

Microvoltmeter (115 V, 50/60 Hz)

U8530501-115

Additionally recommended:
U8533997 Magnetic Field Sensor, Axial/Tangential

U8531401-230
U8531401-115
Measuring Amplifier

Measuring amplifier for recording very small voltage, current and charge. For display purposes, any DC meter capable of measuring in the range up to 10 V can be used with no additional configuration. Including offset correction and polarity switch. Additional outputs are provided so that the -15 V and +15 V operating voltage can be tapped for use in external circuitry, e.g. bridge circuits.

Input: BNC sockets
 Measuring range with reference to 1 V output voltage:
 Voltage: 0.1 mV – 100 V, 7 ranges
 Current: 10 pA – 10 μ A, 7 ranges
 Charge: 10 pAs – 100 nAs, 5 ranges
 Input resistance: 10 Ω (voltage), compensated 0 Ω (charge, current)

Overvoltage protection: up to 300 V
 Precision: typically 3%
 Signal output: 0 – 10 V, configurable zero point, polarity switch
 Fixed voltage output: \pm 15 V, max. 50 mA
 Dimensions: approx. 235x230x180 mm³
 Weight: approx. 2.8 kg

Measuring Amplifier (230 V, 50/60 Hz)

U8531401-230

Measuring Amplifier (115 V, 50/60 Hz)

U8531401-115

Additionally required:
U17450 Analogue Multimeter AM50

U8530501-230
U8530501-115



U42000

Mechanical Balance 610

- Solid, all-metal construction
 - Notched positions for sliding weights on three sliding beams
 - Captive sliding weights
 - Magnetic damping
 - Zero point adjustment
 - Extensible scale range
- Scale range: 0 – 610.0 g (2610.0 g with additional weights)
 Readability: 0.1 g
 Sliding weight: 0.1 – 10 g (front), 10 g – 100 g (rear),
 100 – 500 g (centre)
 Plate diameter: 150 mm

U42000

Additional Weights for Mechanical Balance (not shown)
 Additional weights to extend the scale range of the mechanical balance 610 (U42000).

Weights: 1x 0.5 kg, 2x 1 kg

U42007

Mechanical Balance 311

- Solid, all-metal construction
 - Notched positions for sliding weights on four sliding beams
 - Captive sliding weights
 - Magnetic damping
 - Zero point adjustment
- Scale range: 0 – 311.00 g
 Readability: 0.01 g
 Sliding weight ranges: 0.01 – 1 g (1st beam), 1 – 10 g (2nd beam),
 10 – 100 g (3rd beam), 100 – 200 g (4th beam)
 Pan diameter: 100 mm

U42010



U42010

Advantages

- Top quality
- Precision
- High resolution
- Easy to read



U102301

AES 200 Analytical Scales

- Precision analytical scales with automatic adjustment mechanism and high resolution. Tough metal casing with complete glass windscreen, large graphic display and RS232 and USB port. The scales offer practically every function needed in laboratories:
- Counting items
 - Percentage weights
 - Switching between different units
 - Capacity display for weight range
 - GLP/ISO protocols
 - Programmable 4-digit ID number
 - CAL adjustment program for setting accuracy
 - Pipette calibration program
 - Dosing mode
 - Alibi memory and internal memory
- Max. measuring range: 220 g
 Precision: 0.1 mg
 Reproducibility: 0.2 mg
 Linearity: ±0.2 mg
 Time to settle: 4 s approx.
 Item counting
 Minimum weight: 0.5 mg
 References: 10, 20, 50, freely selectable
 Weight display: LCD, 17 mm
 Weighing platform: 85 mm diam.
 Power supply: 13.8 V DC power supply, mains voltage
 110 – 230 V, 50/60 Hz
 Dimensions: 206x335x335 mm³
 Weight: 5.4 kg

U102301

Advantages

- Flexible power (AC adaptor or batteries)
- Easy to clean (sealed front panel)
- Easy to view (high contrast LC-display)
- Integral shipping lock
- Manual disabling of menu
- Weigh below hook



U42050-230



U42048-230,
U42049-230

Electronic Scales Scout Pro

Precision scales with removable stainless steel platform. Multi-function with percentage weighing, totalisation, display hold, and parts counting. Includes calibrating weight.

Electronic Scales Scout Pro 200 g

U42048-230

Electronic Scales Scout Pro 400 g

U42049-230

Electronic Scales Scout Pro 600 g

U42050-230



U42060,
U42061

	U42048-230	U42049-230	U42050-230
Weight range:	0 – 200.00 g	0 – 400.00 g	0 – 600.0 g
Accuracy:	0.01 g	0.01 g	0.1 g
Display:	LCD, 6 digits, 15 mm		
Weight ranges:	g, N, oz, %, unit counter	g, N, oz, %, unit counter	g, kg, N, oz, lb, %, unit counter
Calibration:	Automatic using external weight		
Scale pan:	120 mm Ø	120 mm Ø	165x140 mm ²
Dimensions:	approx. 192x54x210 mm ³		
Weight:	approx. 700 g	approx. 700 g	approx. 800 g

Electronic Scales

Universal scales in robust plastic casing, with easy-clean foil keyboard. Menu functions, easy selection using two buttons. High-resolution, easy-to-read LCD display, overload and underload display, battery or mains operation optional. Automatic shutdown after five minutes in battery operation. Batteries included.

	U42060	U42061
Scale range:	0 – 200.0 g	0 – 5000 g
Accuracy:	0.1 g	1 g
Weight units:	g, lb:oz	g, lb:oz
Counter-balancing range:	subtractive, entire weight range	subtractive, entire weight range
Power supply:	3 AA alkaline batteries	3 AA alkaline batteries
Dimensions:	approx. 193x135x39 mm ³	approx. 193x135x39 mm ³
Weight:	ca. 470 g	ca. 470 g

Accessories:
USB Interface
For connecting Scout Pro to a printer or PC.

U42056



U42056

U11875-230
U11875-115



Magnetic Stirrer with Heater

Magnetic stirrer with stainless steel hotplate and secure safety circuit. Variable heating temperature and smooth starting stirrer motor. Housing resistant to chemicals.

Quantity stirred, max. (H₂O): 10 l
 Speed: 100 – 2000 rpm
 Heater power: 400 W
 Heating temperature range: Room temperature to 320° C
 Work plate: 125 mm diam.
 Dimensions: 168x105x220 mm³ approx.
 Weight: 2.4 kg approx.

Magnetic Stirrer with Heater (230 V, 50/60 Hz)

U11875-230

Magnetic Stirrer with Heater (115 V, 50/60 Hz)

U11875-115



U29025

12L Magnetic Stirrer (230 V, 50/60 Hz)

Electronically regulated magnetic stirrer in stainless steel casing with an aluminium hot plate. Accommodates stand rods (12 mm diam.) and has a 12 V DC output to supply power to accessories. Includes stirring rods.

Maximum speed: 1500 rpm
 Hot plate: 135 mm diam.
 Maximum temperature: 450°C
 Power consumption: 400 W
 Dimensions: 165x220x105 mm³
 Weight: 2 kg

U29025

U11876



Magnetic Stirrer

Ultra flat magnetic stirrer with non wearing drive featuring no moving parts. With feature for changing direction of stirring automatically every 30 seconds for improved homogenisation. Work plate and housing resistant to chemicals, non slip and secure base. Including plug in power supply and stirring rods.

Quantity stirred, max. (H₂O): 0.8 l
 Speed: 15 – 1500 rpm
 Work plate: 100 mm diam.
 Power supply: power supply unit 100 V– 240 V, 50/60 Hz
 Dimensions: 117x12x180 mm³ approx.
 Weight: 0.3 kg approx.

U11876

Electrical Burners

Burners for experiments which would have formerly needed to be undertaken using a Bunsen burner. Designed to be both thermally and electrically safe. Heating via a column of hot air with a patented air management system. Featuring operation and temperature displays.

- Controlled via energy regulator with bimetallic strips
- Protected against overheating
- No overheating of housing during long periods of use
- Boils liquids without causing them to spit
- Perfectly sealed against spilt liquids

Liquid reservoir: Up to 140 mm in diameter
 Dimensions: 170x130x195 mm³
 Weight: 3.8 kg



W13650-230

W13651-230

LAB2 Electrical Burner (230 V, 50 Hz)

Operating temperature: 20 – 650°C
 Temperature of heating element: max. 900°C
 Electrical power consumption: 500 W
 Fuse: F-type, 5A, 250 V

W13650-230

LAB3 Electrical Burner (230 V, 50 Hz)

Operating temperature: 20 – 750°C
 Temperature of heating element: max. 1000°C
 Electrical power consumption: 900 W
 Fuse: F-type, 6.3A, 250 V

W13651-230



W13654

Set of 60 Ecoflam Pellets

Pellets for environmentally friendly generation of an open flame on the grid of the LAB2 and LAB3 electrical burners.

W13654

Plate for Metal Filings

Plate for adding to LAB2 and LAB3 electrical burners in order to burn metal filings in an open flame. Complete with central hole for one ECOFLAM pellet.

W13655



W13655

Holder for Glassware

Complete accessories for holding test tubes or round-bottom flasks onto the grid of the LAB2 and LAB3 electrical burners. The holder remains sufficiently cool while the glassware is being heated to be safely touched with fingers.

Tube diameter: 12 mm or 35 mm approx.

W13653



W13653

Wick (not shown)

Spare wick for the spirit lamp (U8621240).
 Length: approx. 100 mm

U8621250

Immersion Heater – 300 W

Immersion heater with protection against overheating (VDE-compliant). Important: operates solely on a mains voltage of 230 V.

U8624110-230

Spirit Lamp

Made of metal, with a knurled screw for feeding the wick and cap for extinguishing the flame.
 Contents: 60 ml

Dimensions: 55mm x 65 mm diam.

Weight: 50 g approx.

U8621240



U8621240



U8624110-230

HD Video Flex®

Robust, ultra high resolution desktop digital colour camera for direct connection to a PC or notebook via a USB interface. Thanks to the ball and socket bearing, video head that can pivot and swivel via its flexible gooseneck, the camera can be easily and accurately connected, e.g. to microscopes and telescopes, or directed towards visual material, running processes or items of scientific or technical interest so that they can be viewed on a monitor. The heavy, triangular base ensures the necessary stability. Audio recordings are possible via a microphone equipped computer. An external power supply is not necessary as the camera is powered via the USB connection. Includes microscope adaptor, Applied Vision™ software and carrying case. Compatible with interactive whiteboards. The Applied Vision™ software for picture recording, reproduction and processing is characterised by its user friendliness and features e.g.

- Full screen, real time video
- Still frame recording
- Recording of films in AVI format
- Time-lapse recording
- Internet streaming
- Can be used in local network
- Zoom function
- Image processing
- Brightness, contrast control and positive/negative image display
- Drawing tools
- Organiser/memo function
- Printout of real time images
- Memory function (jpeg, bmp, tiff)
- Choice of background
- Creation of image collages
- Comparison of two adjacent images
- Measurement of the distance between 2 points or the area of a circle
- Exporting data to an Excel spreadsheet or MS Word
- Compatible with Windows, Mac and Linux
- Free software updates
- Unlimited local licences

W499912

	W499912	U42103	U42104	U42102
Photosensitivity	8 lux	20 lux	20 lux	2 integrated white LEDs
Image digitisation	digital CMOS	digital CMOS	¼" CMOS	digital CMOS
Output signal	digital / USB 2.0	digital / USB 2.0	digital / USB 2.0	digital / USB 2.0
Resolution	HD 1080P	1280x960 SXGA	1280x1024	2048x1536
Live video	up to 30 images per second	up to 30 images per second	up to 30 images per second	up to 30 images per second
TV system	–	–	–	–
Microphone	–	–	–	yes
Lens	8 mm HD	6 mm glass	glass f = 2.8 and 1.729 mm	F2.8 coated
Focal distance	6 mm to infinity	8 mm to infinity		100 mm to infinity
Focus	manual	manual	auto	auto
Microscope adaptor	34.5 mm built-in and 28 mm	34.5 mm built-in and 28 mm	–	28 mm
Power supply	via USB	via USB	via USB	via USB
Cable	USB connecting cable, approx. 170 cm	USB connecting cable, approx. 150 cm	USB connecting cable, approx. 170 cm	USB connecting cable, approx. 180 cm
Dimensions	approx. 180x180x720 mm ³	approx. 180x180x640 mm ³	approx. 180x180x640 mm ³	approx. 200x200x630 mm ³
Weight	approx. 4.55 kg	approx. 1.7 kg	approx. 1.65 kg	approx. 2.04 kg

FlexCam® 2

This modern document camera with high definition (HD) resolution can do the job of multiple presentation devices, e.g. overhead projectors, opaque projectors or slide projectors. Documents, pictures, objects etc. can be laid directly onto the flat base under the camera. The two bright white LEDs integrated into the head of the camera provide excellent illumination of the field of view. A built-in microphone allows sound recordings to be made. Includes microscope adaptor and Applied Vision™ software.

U42102

Vision Viewer™

Lighter version of the HD Video Flex® (W499912) with similar optical properties (without HD resolution) and for the same applications. The difference is that the video head is directly attached to the gooseneck arm (with no universal joint). Compatible with interactive whiteboards. Includes a microscope adaptor and Applied Vision™ software.

U42103

Auto Focus Vision Viewer™

High-resolution, easy-to-use, desk-top colour video camera with a host of uses. Particularly suitable for presenting printed text, images and other objects or even dynamic processes. Includes auto-focus camera lens and wide field of vision (43x36 cm), flexible gooseneck support and integrated USB cable. Compatible with interactive whiteboards. Includes Applied Vision™ software.

U42104



U42102



U42103



U42104



W30600-230

Monocular Course Microscope Model 100 (230 V, 50/60 Hz)

The monocular course microscope Model 100 is distinguished by its robust construction and ease of operation. It is equipped with three achromatic objectives as used in common practice and has a simple object stage with two clips for holding slides. It can be supplemented by means of a variety of spare parts and accessories.

W30600-230



U30723

Binocular Polarisation Microscope

High-quality mechanics and optics along with ease of operation are the stand-out features of the binocular polarisation microscope. Its compact and ergonomic design makes it easier to work with it. The main application for polarisation microscopes is in mineralogy, where they are used for investigating optically anisotropic objects, e.g. crystals or minerals (intrinsic birefringence) or isotropic materials being acted upon by mechanical forces (stress-induced birefringence).

U30723

	W30600-230	U30723
Stand	All-metal stand, arm firmly connected with base, pinion knobs attached on both sides of the stand for coarse and fine focusing	Robust, all metal stand with arm permanently connected to the base. Focussing by means of separate knobs for coarse and fine adjustment located on either side of the stand and operated by rack and pinion drive with ball bearings and retaining lever, adjustable stopper for protecting the object slides and objective.
Tube	Monocular inclined 45°, head rotation 360°	Binocular head, 30° viewing angle, 360° rotatable head, viewing distance adjustable between 54 and 75 mm, ±5 dioptic compensation for both eyepieces
Polarisation equipment	–	Polariser with scale and analyser, which can be inserted into the tube.
Eyepieces	Wide field eyepiece WF 10x 18 mm with pointer and eyepiece lock	Pair of wide field eyepieces WF 10x 18
Objectives	Revolving nosepiece with 3 achromatic objectives 4x / 0.10, 10x / 0.25, 40x / 0.65	Inverted objective revolver with 3 achromatic objectives 4x / 0.10, 10x / 0.25, 40x / 0.65
Enlargement	40x, 100x, 400x	40x, 100x, 400x
Object stage	110x120 mm ² with 2 specimen clips	Circular object stage 120 mm in diameter, which can be rotated 360°, scale with Vernier and 2 specimen clips
Illumination	20 W tungsten lamp integrated in base, power supply 230 V, 50/60 Hz	Adjustable 6 V, 20 W halogen lamp incorporated into the base, universal 85 to 265 V, 50/60 Hz power supply
Condenser	Bright-field condenser N.A. 0.65, iris diaphragm, filter holder and blue filter	Abbe condenser N.A. 1.25 with iris diaphragm, focussed via rack and pinion drive
Dimensions	approx. 175x135x370 mm ³	approx. 240x190x425 mm ³
Weight	approx. 2.9 kg	approx. 6 kg
Supplied	Complete with dust cover	Complete with dust cover

Whiteboards

Metal board with enamelled surface for demonstration experiments using magnetic components, e.g., for mechanics or optics. Scratch- and acid resistant steel board that can be written on using water soluble pens. Wall mounted.



U10030/U10031

Art. No.	Designation	Dimensions
U10030	Whiteboard	600x900 mm ²
U10031	Whiteboard	900x1200 mm ²

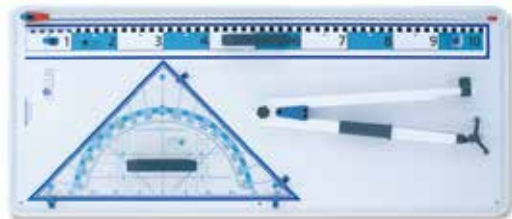

U10045

Set of Drawing Instruments for Whiteboard

Consisting of a flat profile ruler with decimetre scale divisions, a triangular set square for geometry, circle instrument with centimetre scale, and a pointing baton. With storage case.

Flat profile ruler: Marked at decimetre intervals, polystyrene, 1000 mm

Set square triangle: Acrylic, 600 mm

Circle instrument: centimetre scale, 520 mm

Pointing baton: Fibreglass, 1050 mm

U10045

Set of 3 Thermocouples

Set consisting of three different thermocouples for demonstrating the Seebeck effect and measuring thermo-electric voltage as a function of the difference in temperature from a specific reference point. In each case, to create a temperature difference, the contact point of the thermocouple is immersed in a water bath.

Length of leads: 2 m

Operating

temperature: -75°C to 250°C

Connection: 4-mm safety plugs

Sensitivity: 40 $\mu\text{V/K}$ (NiCrSi-NiSi)

43 $\mu\text{V/K}$ (NiCr-NiAl)

54 $\mu\text{V/K}$ (Fe-CuNi)

Contents: 1 Thermocouple type N, NiCrSi-NiSi

1 Thermocouple type K, NiCr-NiAl

1 Thermocouple type J, Fe-CuNi

U8557370



U8495901

Double-Pole Double Throw Switch

Double-pole double throw (DPDT) change-over switch in a robust casing with high dielectric strength. Connection is made via 4-mm safety sockets.

Dimensions: 112 x 62 x 45 mm approx.

Weight: 95 g approx.

U8495901

Cord for experiments

Plaited hemp string on a bobbin. For a variety of uses, e.g. setting up block and tackle using pulleys U30020 to U30027 or making a pendulum with bobs U30035.

Length: 100 m

Diameter: 1 mm

Maximum tension: 50 N

U8724980

Cord, 100 m

100 m length of hemp string, black, rolled onto bobbin.

U8613283

Set of Hook Weights and Thread

Set of propulsion weights and thread for acceleration of sliders on air-cushion track. Consisting of 3 S-shaped hooks, 1 g, 5 S-shaped hooks, 2 g, and 1 roll of sewing thread.

U8557450

Fishing Line, 10 m

Multi-filament braided nylon cord for use in experiments with trolley track.

Length: 10 m

Diameter: 0.14 mm

U8557460

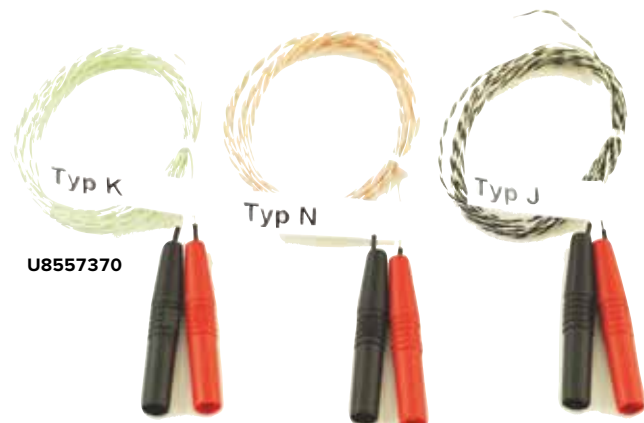

U8557370

U15020



U15021
U15022



Laboratory Jacks

Height adjustable table with continuously variable extension mechanism for raising experiment equipment. May be fixed in place via wing nuts.

Art. No.	Designation	Maximum load	Tabletop	Height of table	Weight
U15022	Laboratory Jack I	30 kg	320x220 mm ²	65 – 250 mm	2.6 kg
U15020	Laboratory Jack II	40 kg	200x200 mm ²	70 – 260 mm	2.3 kg
U15021	Laboratory Jack III	50 kg	160x130 mm ²	60 – 250 mm	1.2 kg



U8557440

Stand with H-Shaped Base

Provides a firm base for large and extensive structures, with six clamping positions for stand rods up to 12 mm diameter.
Max. stand area: 300x280 mm²
Weight: 1.7 kg approx.

U8557440.....



U8611160

Stand Base, A-Shaped

Adjustable duplex tripod base, extremely stable, for holding two rods of 4 up to 15 mm diameter. Made of grey cast iron.

Art. No.	Leg length	Weight
U8611160	200 mm	1.5 kg
U8611150	280 mm	3.7 kg



U13270

Tripod Stand

Adjustable duplex tripod base, extremely stable, for holding two rods of up to 16 mm diameter. Distance between rods 135 mm.

Art. No.	Leg length	Weight
U13270	150 mm	1450 g
U13271	185 mm	1850 g



U13265

Barrel Foot, 1 kg

Heavy base for holding rods of up to 13 mm diameter. Made of powder-coated cast iron.

U13265.....



U8611210

U8611200

Barrel Foot

Heavy base to accommodate stand rods up to 12 mm in diameter and rectangular plates of up to 10 mm or 12 mm thickness. Made of painted cast iron.

Art. No.	Weight	Height	Diameter
U8611200	0.9 kg	56 mm	64 mm
U8611210	0.5 kg	47 mm	54 mm

Multiclamp

Universal clamp for attachment of rods up to 13 mm diameter and for holding plates, rulers, etc. of up to 13 mm thickness in a multitude of alignments. Nickel-plated steel screws.

U13255



U13255

Bosshead

Bosshead for connecting rods of up to 16 mm diameter. Powder-coated zinc die-casting, 110 g. Nickel-plated steel screws.

U13250



U13250

Cross-Bosshead

Cross-bosshead for connecting rods of up to 20 mm diameter. Powder-coated zinc die-casting, 130 g. Nickel-plated steel screws.

U13256



U13256

Clamp with Hook

Clamp with hook for attaching rods of up to 16 mm diameter. Powder-coated zinc die-casting, 93 g. Nickel-plated steel screws.

U13252



U13252

Clamp with Jaw Clamp

Stand clamp with jaw clamp for attaching rods up to 16 mm diameter. Powder-coated zinc die-casting, 190 g. Clamp with cork lining. Clamping width: 20 – 40 mm

U13253



U13253

Universal Jaw Clamp

Clamp with cork lining. Unpainted zinc die-casting, 180 g. Clamping width: 0 – 80 mm

U13261



U13261

Adjustable Double Clamp

Double clamp with two grippers which can be rotated by 360° with respect to one another for connecting rods of up to 16 mm in diameter. Powder coated zinc die casting, 180 g. Nickel-plated steel screws.

U13257



U13257

Table Clamp

Table clamp for vertically attaching rods of up to 13 mm to tabletops. Powder-coated aluminum alloy, 350 g. Clamping width: 0 – 60 mm

U13260



U13260



U15005

U15002



U8611461
U8611460

SW Stand Equipment Set

Stand equipment for easy, understandable and stable assemblies, e.g. for investigating mechanical oscillations and waves using the sensors from the SW sensors set (U61023-230 or U61023-115). Including SW base plate as non-tilting base to accommodate the stand rods, two double clamps and SW tie bar. The SW tie bar serves as multi-function holder for fitting between stand rods on the base plate in order to build set-ups featuring the dynamic force sensors from the SW sensors set

Base plate: 345x240x16 mm³ approx.
Stand rods: 400 mm x 10 mm diam. approx.

Contents:

- 1 SW Base plate
- 2 Stand rods with internal and external thread
- 2 Stand rods with external thread
- 2 SW Double clamps
- 1 SW Tie bar

U61022

Additionally recommended:
U8611461 Steel Rod 280 mm
U8611460 Steel Rod 400 mm



U61022

U11055

Drilled Rod

Plastic rod with six lateral bore holes and one axial bore hole for the attachment of components with 4 mm plugs.

Length: 250 mm
Diameter: 12 mm
Bore hole spacing: 19 mm and 50 mm
Bore hole diameter: 4 mm

U11055



U10146

Silicone Tube

Silicone, transparent, 1 m long.
Internal diameter: 6 mm
Wall thickness: 2 mm

U10146



U8557220

Holder for Plug-in Components

Holding rod with 4-mm connector sockets to accommodate and connect components with two plugs matching a 19-mm or 50-mm grid or conductor loops for verifying the Biot-Savart law. Suitable for both 4-mm laminated plugs as well as 4-mm safety plugs.

Max. continuous current: 25 A
Diameter of rod: 10 mm
Dimensions: 110x20x135 mm³ approx.
Weight: 120 g approx.

U8557220



U10148

U10147

Vacuum Hoses

Vacuum hoses made of natural rubber according to DIN 12865. Colour red.



U10141

U10140

Art. No.	Length	Internal diameter	Wall strength	Temperature range
U10148	1 m	4 mm	4 mm	-30° up to + 85°
U10147	1 m	6 mm	4 mm	-30° up to + 85°
U10140	1 m	8 mm	5 mm	-30° up to + 85°
U10141	1 m	10 mm	5 mm	-30° up to + 85°

For a reliable connection

Set of 15 Experiment Leads, 75 cm

Set of 15 copper leads with highly-flexible PVC insulation, 75 cm long, with stackable 4 mm laminated plugs at both ends. Five leads in each of the colours red, black and blue.

Voltage: Safety extra low voltage
Plugs and sockets: Nickel-plated

Art. No.	Conductor cross-section	Max. continuous current
U13800	1 mm ²	19 A
U13801	2.5 mm ²	32 A

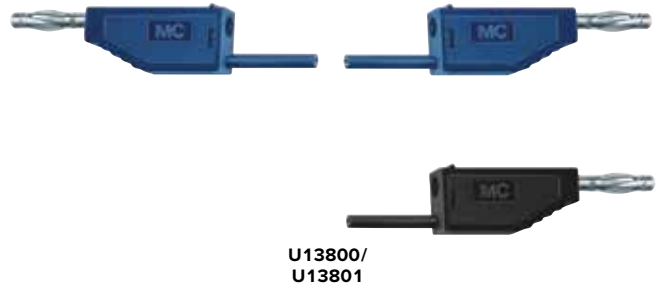

Set of Experiment Leads for Electron Tube Experiments

Set of 18 copper leads with highly flexible PVC insulation for all connections to series D electron tubes.

Wire cross-section: 1 mm²
Max. continuous current: 19 A
Plug and jack: 4 mm (nickel-plated)

U138101

Quantity	Length	Colour	Connection
3	75 cm	red	Safety jack/plug
4	75 cm	blue	Plug/plug
2	75 cm	black	Plug/plug
2	50 cm	blue	Plug/plug
5	25 cm	black	Plug/plug
2	25 cm	red	Plug/plug

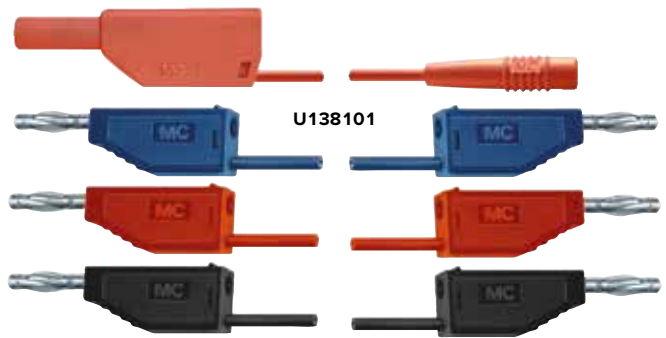

Experiment Lead, Plug and Socket

Experiment lead with 4 mm laminated plug and 4 mm socket. 75 cm long, colour red.

Wire cross-section: 1 mm²
Max. continuous current: 19 A

U13760

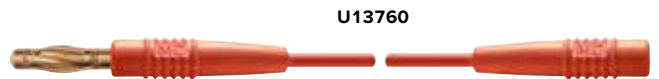

Experiment Lead, Safety Plug and Socket

Experiment lead with stackable 4 mm safety-grade laminated plug and 4 mm socket. 75 cm long, colour red.

Wire cross-section: 1 mm²
Max. continuous current: 19 A

U13761



Set of 10 Crocodile Clips 4 mm, Not Insulated

Not insulated test clips with 4 mm sockets for accepting 4 mm-test leads or any other 4 mm-Multilam plug. Connection also possible with screw clamp or soldering.

U13821



Pair of Experiment Leads, 75 cm

Set of two copper leads with highly flexible PVC insulation, 75 cm long, black, with cascadable 4 mm laminated plugs at both ends.

Conductor cross-section: 1 mm²
Voltage: Safety extra low voltage
Max. continuous current: 19 A

U13813



Safety First

Set of 6 Safety Crocodile Clips 4 mm

Fully insulated safety crocodile clips (3x red, 3x black) with 4 mm safety socket for accepting 4 mm safety test leads or any other 4 mm Multilam plug.

U13820



U13820



U13820

Pair of High-Voltage Cables, 150 cm

Set of two copper leads sheathed in highly flexible PVC, 150 cm long with 4-mm safety plugs at either end housed in rigid insulating sleeves. One red cable and one black.

Cable cross section: 0.5 mm²

Voltage: Up to 5 kV

U13814



U13814

Set of Fuses

Set of fuses, including 105 fast-acting fuses of a high switching capacity and 135 slow-acting fuses of a low switching capacity. Stored in a box.

Dimensions: 5 mm diam. x 20 mm

Rated voltage: 250 V

Type SP:

Material: Glass tube

Time response: Fast

Switching capacity: 35 A @ 250 V

Assortment: 1 A (15 units); 3.15 A; 6.3 A; 10 A

(30 units in each case)

Type FST:

Material: Ceramic tube

Time response: Slow

Switching capacity: 35 A @ 250 V

Assortment: 0.5 A; 1 A; 1.25 A; 1.6 A; 2 A; 2.5 A; 3.15 A;

6.3 A; 10 A (15 units each)

U11269

U11269

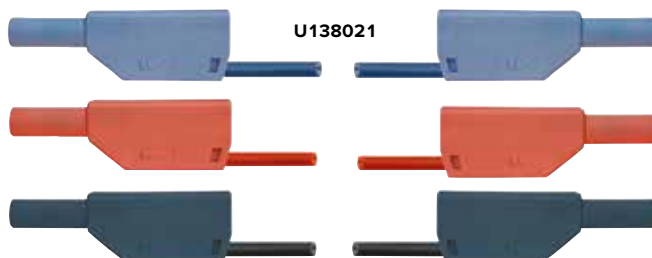

U138021

Set of 15 Safety Experiment Leads, 75 cm

Set of 15 copper leads with highly-flexible PVC insulation, 75 cm long, with stackable 4 mm safety laminated plugs at both ends. Four leads in each of the colours red, black and blue, and one lead in each of the colours green, brown and yellow-green.

Wire cross-section: 2.5 mm²

Voltage: Low voltage

Max. continuous current: 32 A

U138021

Safety Experiment Leads, 75 cm (not shown)

Copper leads in highly flexible PVC insulation, 75 cm long, black, with stackable 4 mm safety laminated plugs at both ends.

Conductor cross-section: 2.5 mm²

Voltage: Safety extra low voltage

Max. continuous current: 32 A

Pair of Safety Experiment Leads, 75 cm, black

U13812

Pair of Safety Experiment Leads, 75 cm, red

U13817

Pair of Safety Experiment Leads, 75 cm, blue, red

U13816

Set of Three Safety Experiment Leads, 75 cm, yellow/green, blue, black

U13818

Set of Three Safety Experiment Leads for Free-Fall Apparatus (not shown)

Set of three copper leads with highly flexible PVC insulation for connecting to free-fall apparatus (U8400830), with stackable 4 mm safety laminated plugs at both ends. Two leads 75 cm long, one red and one black. One green lead, 150 cm long.

Wire cross-section: 2.5 mm²

Voltage: Low voltage

Max. continuous current: 32 A

U13811

	SP 5x20 F 3.15 A	SP 5x20 F 6.3 A	FST 5x20 T 500 mA	FST 5x20 T 1.6 A	FST 5x20 T 3.15 A
	0001.1009	0001.1012	0034.3114	0034.3119	0034.3122
	SP 5x20 F 3.15 A	SP 5x20 F 10 A	FST 5x20 T 1 A	FST 5x20 T 2 A	FST 5x20 T 6.3 A
	0001.1009	0001.1014	0034.3117	0034.3120	0034.3125
	SP 5x20 F 1 A	SP 5x20 F 6.3 A	SP 5x20 F 10 A	FST 5x20 T 1.25 A	FST 5x20 T 10 A
	0001.1004	0001.1012	0001.1014	0034.3118	0034.3121



Experiment Leads and Cables

Lab Material

For high-frequency signals

T-Piece, BNC

T-piece for connecting two high-frequency patch cords to one BNC jack.

U11261

Adaptor, BNC Plug/4 mm Jacks

Crossover from a BNC plug to 4 mm jacks with 19 mm spacing.

U11259

Adaptor, BNC Jack/4-mm-Plugs

Crossover from a BNC jack to 4 mm plugs with 19 mm spacing.

U11260

BNC Patch-Cord Connector

Coupling at either end with a BNC jack for connecting high-frequency patch cords.

U11258

HF-Patch Cord

Shielded patch cords for low loss, low capacitance transmission of high frequency signals. Equipped at either end with a BNC plug.

Impedance: 50 Ω

Length: 1 m

U11255

HF Patch Cord, BNC/4 mm Plug

Shielded patch cord for low loss, low capacitance transmission of high frequency signals. Lead with a BNC plug at one end and two 4 mm plugs at the other end.

Impedance: 50 Ω

Length: 1 m

U11257

Ultrasonic Adaptor Lead

Adaptor lead for rectifying high-frequency output signals from the ultrasonic electronic control unit in order to conduct measurements with any DC voltmeter. The ultrasonic electronic control unit is part of ultrasonic equipment sets used in student experiments.

Input: BNC plug

Output: 2 x 4-mm plugs

Length: 65 cm

Weight: 20 g approx.

U8557390

Pellets

Granules for filling calorimeters.

Aluminium Shot, 100 g

U8442610

Copper Shot, 200 g

U8442620

Glass Shot, 100 g

U8442640



Adaptor, BNC Plug/4 mm Safety Jacks

Crossover from a BNC plug to 4 mm safety jacks with 19 mm spacing.

U29564

Indigo Solution

30 ml indigo solution in a flask, for colouring water in demonstration experiments.

U8410620

Glycerine

250 ml of glycerine in aqueous solution for experiments on viscosity. In glass bottle
Concentration: 85%

U8496816



U14201

U14200

U21885

**Plane Mirror**

Glass mirror, ground edges.
Dimensions: approx.
170x130 mm²

U21885



U29453

U14206

U14205

Watch Glass Dishes

Made of thin-walled soda-glass, ground rim. Diameter 80 mm or 120 mm.

Art. No.	Designation
U14200	Set of 10 Watch Glass Dishes, 80 mm
U14201	Set of 10 Watch Glass Dishes, 120 mm

Graduated Cylinder, 250 ml

Graduated cylinder made of borosilicate glass. Tall form with spout and hexagonal base.

Scale: 250 ml
Divisions: 2.5 ml

U29453

Free-Standing Cylinder

Non-graduated cylinder made of Duran glass. With round base and coarse ground rim.

Height: 300 mm
Diameter: 40 mm

U14206

Graduated Cylinder, 100 ml

Graduated cylinder made of Duran glass. Tall form with spout with hexagonal base.

Scale: 100 ml
Divisions: 1 ml

U14205

Vessel with Overflow

Vessel with overflow, 275 ml, made of acrylic.

U8411310



U14211

U14210

U8411310

Beakers, 600 ml

Set of 10 beakers made of borosilicate glass. With scale, 100 ml divisions and spout.

Art. No.	Designation
U14210	Set of 10 Beakers, Low Form
U14211	Set of 10 Beakers, Tall Form

Round-Bottomed Flask (not shown)

Round-bottomed flask made of borosilicate glass.

Art. No.	Designation
U29427	Round-Bottomed Flask, 250 ml
U29428	Round-Bottomed Flask, 500 ml

Plastic Trough (not shown)

Transparent plastic trough.

Dimensions: 70x130x85 mm³

T52006



U8475830



U14224

Cuvette, Rectangular, 80x30x80 mm³

Plane-parallel cuvette of acrylic with highly-polished optical surfaces for investigating the paths of light beams in liquids.

Dimensions: 80x30x80 mm³

U8475830

DIN-B Burette with Schellbach Stripe, 10 ml

Burette tube for measuring small amounts of liquid with Schellbach stripe and tap at the side with standard ground (NS) glass connector and cock plug.

Volume: 10 ml
Scale divisions: 0.02 ml
Error limits: Class B

U14224

Resonance Bowl

Dating from the Song Dynasty (960 – 1279 A.D.), this bronze basin has two prominent handles and four fish in relief on the bottom, as well as lines emanating from the mouths or tails of the fish. When the handles are rubbed briskly with the palms of the hands, a harmonious sound is heard and standing waves are excited in the four quadrants along the circumference, causing water columns to come alive, spouting more than 30 cm into the air, as if squirting from the fish.

Diameter: approx. 380 mm
Height: approx. 150 mm

U30001

U30001



Pythagorean Cup

Pythagoras is known to most students today as the author of the Pythagorean Theorem ($a^2 + b^2 = c^2$). There was far more to Pythagoras' philosophy than this: he was a deep thinker on religion, the nature of the soul, and the harmony of the cosmos. With the "Pythagorean Cup" he illustrated to his students the virtues of moderation: when filled halfway, it retains its contents, but if it's too full, all of the liquid drains out through a hole in the bottom. Our Pythagorean cup is manufactured of clear blown glass. The secret of the construction is a siphon, which is built in the centre of the cup. Ideal to explain to your students the principle of a siphon with an historical background.

Height: approx. 250 mm
Diameter: approx. 80 mm

U14350

U14350



Magic Mirror

The Western Han "Light-Transmitting" Mirror known as the magic mirror has a history of more than two thousand years. It is a miracle created by the ingenious Chinese craftsmen in Western Han Dynasty (206 B.C. – 24 A.D.) through combining the optical and mechanical principles with superb metallurgical technology. Those wonderful mirrors are able to reflect the decorative pattern cast on their backs onto a white screen when sunlight is shining on their polished fronts. The fabrication technology of this magic mirror was lost in Song Dynasty (960 – 1279 A.D.) and had remained a mystery until 1975. With a perfect combination of science and technology, culture and art, the celebrated Magic Mirror is a perfect classroom tool as well as a cherished gift.

Diameter: approx. 70 mm
Thickness: approx. 10 mm

U300001

U300001

Yi Bell

The "faith bell" is shaped after the two-tone bell unearthed in the tomb of Marquis Yi in 1978. This reproduction has been cast using a newly designed copper alloy containing magnesium and exhibits a unique physical property resulting from a combination of bell design and the effect of temperature on vibrational damping. At room temperature the bell exhibits excessive damping and gives a dull sound when struck, as though it were made of wood. After being heated with an alcohol burner for several minutes, the bell is restruck and rings beautifully.

Dimensions: approx. 295x210x120 mm³

U30002

U30002

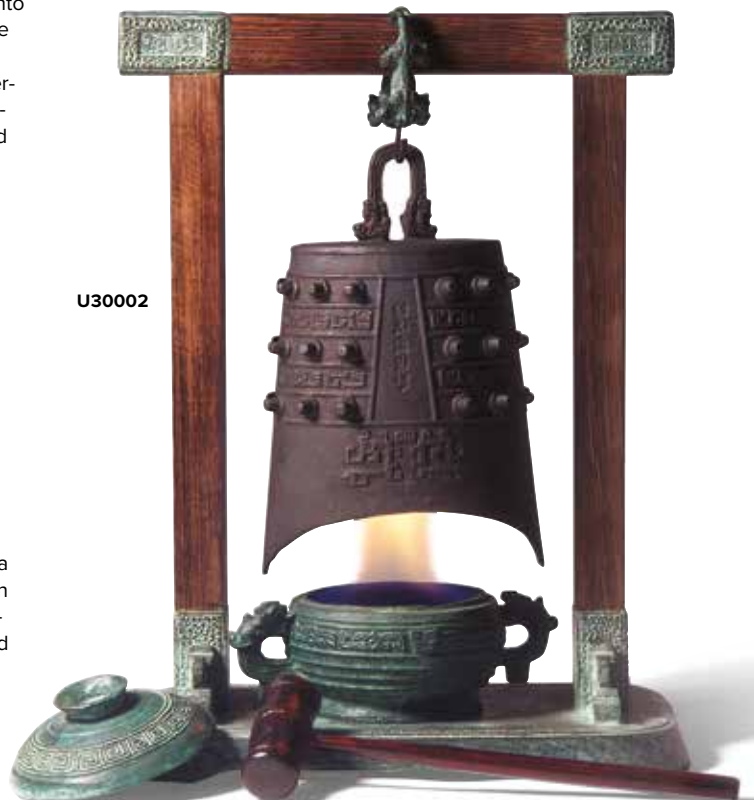

Description	Art. No.	Page
3B NET <i>lab</i> [™]	U11310	38
3B NET <i>log</i> [™] (115 V, 50/60 Hz)	U11300-115	39
3B NET <i>log</i> [™] (230 V, 50/60 Hz)	U11300-230	39
3B NET <i>log</i> [™] with Ethernet Port (115 V, 50/60 Hz)	U11300ip-115	39
3B NET <i>log</i> [™] with Ethernet Port (230 V, 50/60 Hz)	U11300ip-230	39
3B POWER <i>log</i> (115 V, 50/60 Hz)	U11305-115	46
3B POWER <i>log</i> (230 V, 50/60 Hz)	U11305-230	46
3B Student Kit	–	8 – 14
6-Piece Model of a Human Eye	F15	191
– A –		
Absolute Pressure Sensor, 2500 hPa	U11320	43
AC/DC Power Supply 0 – 12 V, 3 A (115 V, 50/60 Hz)	U117601-115	268
AC/DC Power Supply 0 – 12 V, 3 A (230 V, 50/60 Hz)	U117601-230	268
AC/DC Power Supply 0 – 12 V, 3 A, stab. (115 V, 50/60 Hz)	U8521105-115	268
AC/DC Power Supply 0 – 12 V, 3 A, stab. (230 V, 50/60 Hz)	U8521105-230	268
AC/DC Power Supply 0 – 20 V, 0 – 5 A (115 V, 50/60 Hz)	U8521131-115	268
AC/DC Power Supply 0 – 20 V, 0 – 5 A (230 V, 50/60 Hz)	U8521131-230	268
AC/DC Power Supply 0 – 30 V, 5 A (230 V, 50/60 Hz)	U117301-230	268
AC/DC Power Supply 0 – 30 V, 6 A (115 V, 50/60 Hz)	U33035-115	231, 269
AC/DC Power Supply 0 – 30 V, 6 A (230 V, 50/60 Hz)	U33035-230	231, 269
AC/DC Power Supply 1/ 2/ 3/ – 15 V, 10 A (115 V, 50/60 Hz)	U33030-115	269
AC/DC Power Supply 1/ 2/ 3/ – 15 V, 10 A (230 V, 50/60 Hz)	U33030-230	269
Acceleration Sensor, ±25g	U11362	41
Acceleration Sensor, ±5g	U11363	41
Accessories for Faraday Effect	U8496420	168
Accessories for Kinetic Gas Theory	U56004	139
Accessories for Rope Waves	U85560081	100
Accessories for Spring Oscillations	U56003	100
Accessory Set for the Interferometer	U10351	183
Achromatic Objective 10x / 0.25	W30614	156
Acoustics Kit	U8440012	15
Acrylic Body with Drilled Holes	U10027	115
Acrylic Puck	U40513	65
Adaptor Cables 4-mm/2-mm Plug, Pair of	U10369	128
Adaptor Flange DN 16 KF / NS 19/26	U14516	93
Adaptor Flange DN 16 KF / Shaft 12 mm	U14515	93
Adaptor, BNC Jack/4-mm Plugs	U11260	301
Adaptor, BNC Plug/4 mm Jacks	U11259	301
Adaptor, BNC Plug/4 mm Safety Jacks	U29564	301
Addition of Colours School Apparatus	U11060	171
Additional Coil for Tesla Transformer	U8496255	231
Additional Weights f. Mechanical Balance	U42007	288
Adjustable Double Clamp	U13257	297
Adjustable Slit K	U8476675	150 – 151
Adjustable Slit on Stem	U8474015	158
Aerodynamics	–	94
Air Cushion Plate	U15420	137
Air Cushion Table (230 V 50/60 Hz)	U405002-230	64
Air Cushion Table (115 V 50/60 Hz)	U405001-115	64
Air Flow Apparatus	U8404300	95
Air Flow Generator (115 V, 50/60 Hz)	U15425-115	63, 94
Air Flow Generator (230 V, 50/60 Hz)	U15425-230	63, 94
Air Track	U20610	62 – 63
Alcohol Meter	U14290	84
Alignment Laser Diode	U14024	184 – 187
Aluminium Plates, Set of 10	U11105	213
Aluminium Puck	U40514	65
Aluminium Shot, 100 g	U8442610	301
Aluminium Test Block with Protractor Scale	U10022	114
Aluminium Calorimeter	U10367	128
Amici Direct Vision Prism	U14020	167
Ammeter, AC	U11812	278
Ammeter, DC	U11810	278
Amplifier	–	287
Analogue Multimeter AM50	U17450	278
Analogue Multimeter AM51	U17451	278
Analogue Multimeter ESCOLA 100	U8557380	279
Analogue Multimeter ESCOLA 30	U8557330	279
Analogue Oscilloscope, 1x10 MHz (230 V, 50/60 Hz)	U11234-230	275
Analogue Oscilloscope, 2x20 MHz (230 V, 50/60 Hz)	U33070-230	275
Analogue Oscilloscope, 2x30 MHz	U11175	275
Analytical Scales AES200 (230 V, 50/60 Hz)	U102301	289
Aneroid Barometer F	U29948	123
Apertures, Optical	–	161 – 165
Apparatus for Investigation of Capillary Effects	U58021	87
Apparatus for Measuring Young's Modulus	U8557260	89
Archimedes Cup	U17207	83
Areometers, Set of 3	U16106	84

Description	Art. No.	Page
Arm Phantom Set	U10019	118
Assembly Kit "Bell, Relay and Bimetallic Switch"	U8497700	204
Astronomy	–	56
Atomic and Nuclear Physics	–	246 – 265
Atomic Orbitals	–	250
Atwood's Machine	U40550	70
Auto Focus Vision Viewer [™]	U42104	292 – 293
Auxiliary Coil	U19106	236
– B –		
Balance Weights	–	54
Ball and Ring	U409001	130
Ball with Ring	U8442500	130
Ballistic Pendulum	U10362	69
Balloons, Set of 100	U29496	90
Band Wave Device	U8431776	101
Bar Magnet, AlNiCo, 70 mm	U8491820	214
Bar Magnets, 80 mm, Pair	U19550	214
Bar Magnets, AlNiCo, 60 mm, Pair with Two Iron Yokes	U19551	214
Barometer	U11325	43
Baroscope	U21853	91
Barrel Foot, 1000 g	U13265	296
Barrel Foot, 500 g	U8611210	296
Barrel Foot, 900 g	U8611200	296
Basic Equipment Set for the X-Ray Apparatus	U19205	258c
Basic Experiment Board (115 V, 50/60 Hz)	U11380-115	205
Basic Experiment Board (230 V, 50/60 Hz)	U11380-230	205
Basic Set Bragg	U19212	258c
Basic Set for Kröncke Optical System (115 V, 50/60 Hz)	U8477120-115	32 – 33
Basic Set for Kröncke Optical System (230 V, 50/60 Hz)	U8477120-230	32 – 33
Basic Student Experiments	–	34
Battery Holder in 3B Box	U29579	200 – 201
Battery Holder, P4W50	U333102	209
Beakers, Low Form, Set of 10	U14210	302
Beakers, Tall Form, Set of 10	U14211	302
Beam Balance	U17205	55
Bench Scales, Harvard Junior	U42047	55
Bicycle Dynamo, Transparent	U29538	227
Bicycle Wheel Gyroscope	U450001	74
Binaural Hearing	–	107
Binocular Polarisation Microscope	U30723	294
Biot-Savart	–	221
Block and Tackle, Experiment Set	U30028	59
Block for Friction Experiments	U8409250	58
BNC Patch Cord Connector	U11258	301
Board for Laser Ray Box	U17306	148
Bodies for Air Resistance and Buoyancy	–	121
Bolometer	U8461300	121
Bosshead	U13250	297
Boyle-Mariotte Apparatus	U172101	140
Bragg Drive	U40207	258d – e
Brass Wire 0.3 mm / 50 m	U8495550	198
Bravais Lattices, Set of 14	U40020	248 – 249
Breast Model with Benign Tumor	L55/1	116
Broken Down Cubic Decimetre	U29491	51
Buffer Solution	U11351	45
Bulbs E10, 1.3 V, 60 mA, Set of 10	U29593	199
Bulbs E10, 12 V, 100 mA, Set of 10	U29512	199
Bulbs E10, 12 V, 500 mA, Set of 10	U29513	199
Bulbs E10, 3.5 V, 150 mA, Set of 10	U29514	199
Bulbs E10, 3.5 V, 200 mA, Set of 10	U29515	199
Bulbs E10, 3.8 V, 300 mA, Set of 10	U29589	199
Bulbs E10, 4 V, 40 mA, Set of 10	U29590	199
Bulbs E10, 6 V, 1 A, Set of 10	U29592	199
Bulbs E10, 6 V, 100 mA, Set of 10	U29517	199
Bulbs E10, 6 V, 350 mA, Set of 10	U29516	199
Bulbs E10, 6 V, 50 mA, Set of 10	U29591	199
Buoyancy Apparatus	U8410355	83
Button on 3B Box	U29518	200 – 201
– C –		
Calcite Crystal	U8500944	167
Callipers Model	U29622	51
Callipers S	U29625	50
Callipers, 150 mm	U10071	50
Calorimeter 200 ml	U8441050	128
Calorimeter Cylinder, Al	U30071	129
Calorimeter Cylinder, Brass	U30072	129
Calorimeter Cylinder, Cu	U30073	129
Calorimeter Cylinder, Steel	U30074	129
Calorimeter Cylinders, Set of 4	U30070	129
Calorimeter with Heating Coil, 1200 ml	U8441010	129
Calorimeter with Heating Coil, 150 ml	U8441020	129
Calorimeters	–	129
Capacitance Decade	U118211	204
Capacitance Decade 0.1 µF	U11190	203
Capacitance Decade 1 µF	U11191	203
Capacitor 0.1 µF, 100 V, P2W19	U333061	206
Capacitor 0.22 µF, 250 V, P2W19	U333053	206
Capacitor 0.47 µF, 100 V, P2W19	U333062	206

Description	Art. No.	Page
Capacitor 1 μF , 100 V, P2W19	U333063	206
Capacitor 1 nF, 100 V, P2W19	U333057	206
Capacitor 10 μF , 35 V, P2W19	U333065	206
Capacitor 10 nF, 100 V, P2W19	U333060	206
Capacitor 100 μF , 35 V, P2W19	U333067	206
Capacitor 100 pF, 160 V, P2W19	U333055	206
Capacitor 1000 μF , 35 V, P2W19	U333106	206
Capacitor 2.2 μF , 63 V, P2W19	U333064	206
Capacitor 2.2 nF, 160 V, P2W19	U333058	206
Capacitor 22 nF, 100 V, P2W19	U333051	206
Capacitor 2200 μF	U51012	202
Capacitor 4.7 μF , 63 V, P2W19	U333054	206
Capacitor 4.7 nF, 100 V, P2W19	U333059	206
Capacitor 47 μF , 35 V, P2W19	U333066	206
Capacitor 47 nF, 100 V, P2W19	U333052	206
Capacitor 470 μF , 16 V, P2W19	U333068	206
Capacitor 470 pF, 160 V, P2W19	U333056	206
Capacitor Plates 125 cm^2 , Pair of	U8492330	197
Capacitor Plates 250 cm^2 , Pair of	U8492320	197
Capacitor Plates 500 cm^2 , Pair of	U8492310	197
Carbon Configurations, Set of 3	U40030	248 – 249
Carbon Electrodes	U58011	212
Carbon Plates, Set of 5	U11106	213
Cardboard Plate	U8492341	197
Cartesian Diver	U14090	83
Cast Iron Bolts, Set of 10	U8442110	130
Castor Oil	U10401	139
Cathode Ray Tube	U8481320	243
Cavendish Torsion Balance	U40205	56
CCD HD Sensor	U22058	172 – 173
Cell Holder on Stem	U11112	175
Centre of Gravity Plate	U8409270	57
Centrifugal Pump	U10005	117
Change-Over Switch (SPDT) on 3B Box	U29802	200 – 201
Change-Over Switch, Double Pole, P4W50	U333099	208
Chaotic Pendulum E	U8557340	76
Charge and Discharge Apparatus (115 V, 50/60 Hz)	U10800-115	210
Charge and Discharge Apparatus (230 V, 50/60 Hz)	U10800-230	210
Charge Indicator	U8557100	193
Charge Spoon, Large	U11052	194
Charge Spoon, Small	U11051	194
Charge Storage Device with Piezo Charger	U8557110	193
Chladni Plate, Circular	U56005	101
Chladni Plate, Square	U56006	101
Chrome-Nickel Wire 0.5 mm / 50 m	U8495515	198
Chrome-Nickel Wire 0.3 mm / 100 m	U8495505	198
Clamp for Projectile Launcher	U10361	68
Clamp K	U84755401	150 – 151
Clamp with Hook	U13252	297
Clamp with Jaw Clamp	U13253	297
Clamps D, Pair	U8497181	230
Cloud Chamber	U8483220	260
Coil D with 1200 Taps	U8497440	228
Coil D with 600 Taps	U8497430	228
Coil D with 6000 Taps	U8497450	228
Coil D, 900 Turns	U8497390	229
Coil on Acrylic Base	U8491793	219
Coil S with 1200 Taps	U8498085	230
Coil S with 2400 Taps	U8498090	230
Coil S with 600 Taps	U8498070	230
Coil S with 800 Taps	U8498080	230
Coil Spring Slinky	U8405830	99
Coil Springs	–	53
Coil with 600 Windings on 3B-Box	U29595	200 – 201
Coil with Variable Number of Turns per Unit Length	U8496175	220
Coil, 10 mH, P2W19	U333091	207
Collimator lens $f = +75$ mm	U14044	184 – 187
Colour	–	170 – 171
Colour Filters, Primary Colours, Set of 3	U21878	165
Colour Filters, Secondary Colours, Set of 3	U21879	165
Colour Filters, Set of 7	U19530	165
Colour Mixing, Equipment Set	U21883	171
Communicating Tubes	U58020	87
Compass	U19561	217
Compass Magnet with Plastic Bowl	U19563	215
Complete Fine Beam Tube System T	UL18575	245
Component Balance	U8404261	94
Component Holder	U22010	158
Components for Electronics Experiments, Set of	U8557280	209
Computer Tomography	–	119
Computer-Aided Experimentation	–	38 – 47
Concave Lens K, $f = -100$ mm	U8475951	150 – 151
Concave Lens K, $f = -500$ mm	U8475961	150 – 151
Concave Lens N, $f = -100$ mm	U8470140	152
Concave Lens on Stem $f = -100$ mm	U17107	157
Concave Lens on Stem $f = -200$ mm	U17108	157
Concave Mirror K	U8475205	150 – 151
Concave Mirror on Stem +75 mm	U17110	157
Conducting Sphere, $d = 30$ mm, with 4 mm Plug	U8532126	194

Description	Art. No.	Page
Conducting Sphere, $d = 85$ mm, with 4 mm Plug	U8492350	194
Conductivity Electrode	U11066	213
Conductivity Sensor	U11335	45
Conductivity Standards, Set of 3	U11334	45
Conductivity Tester	U11065	213
Conductors and Non-Conductors, Set of	U8495350	199
Conductors for Biot-Savart Experiments, Set of 4	U8557240	221
Conductors in Magnetic Fields	–	222 – 227
Connecting Lead with Two Metal Rods	U8498287	106
Connector Box (115 V, 50/60 Hz)	U8533381-115	40
Connector Box (230 V, 50/60 Hz)	U8533381-230	40
Constant Velocity Student Kit, 3 Tubes	U45060	34
Constant Velocity Student Kit, 4 Tubes	U45060-4	34
Constantan Wire 0.4 mm / 50 m	U8495537	198
Constantan Wire 0.3 mm / 100 m	U8495532	198
Constantan Wire 0.5 mm / 50 m	U8495540	198
Constantan Wire 0.2 mm / 100 m	U8495527	198
Contact Stand with Terminal Sockets	U8497740	199
Control Unit for Critical Potential Tubes (115 V, 50/60 Hz)	U186501-115	256 – 257
Control Unit for Critical Potential Tubes (230 V, 50/60 Hz)	U186501-230	256 – 257
Control Unit for Spectrum Lamps (115 V, 50/60 Hz)	U21905-115	176
Control Unit for Spectrum Lamps (230 V, 50/60 Hz)	U21905-230	176
Convex Concave Mirror, $f = \pm 100$ mm	U15511	146
Convex Lens K, $f = 100$ mm	U8475911	150 – 151
Convex Lens K, $f = 150$ mm	U8475921	150 – 151
Convex Lens K, $f = 200$ mm	U8475925	150 – 151
Convex Lens K, $f = 300$ mm	U8475931	150 – 151
Convex Lens K, $f = 50$ mm	U8475901	150 – 151
Convex Lens K, $f = 500$ mm	U8475941	150 – 151
Convex Lens N, $f = 100$ mm	U8470120	152
Convex Lens N, $f = 300$ mm	U8470110	152
Convex Lens N, $f = 50$ mm	U8470130	152
Convex Lens on Stem $f = +100$ mm	U17102	157
Convex Lens on Stem $f = +150$ mm	U17103	157
Convex Lens on Stem $f = +150$ mm	U17106	157
Convex Lens on Stem $f = +200$ mm	U17104	157
Convex Lens on Stem $f = +300$ mm	U17105	157
Convex Lens on Stem $f = +50$ mm	U17101	157
Convex Mirror on Stem -75 mm	U17111	157
Copper Calorimeter	U10366	128
Copper Plates, Set of 10	U11101	213
Copper Sample for Hall Effect	U8557400	265
Copper Shot, 200 g	U8442620	301
Copper Wire 0.3 mm / 100 m	U8495420	198
Copy of a Rowland Grating	U14424	162
Cord for Experiments	U8724980	295
Cord, 100m	U8613283	295
Cork Powder, 10 g Bottle	U8432850	103
Coulombmeter with Rechargeable Battery	U8498303	31
Coupled Harmonic Oscillator	U40445	63
Cr:YAG Module	U14027	184 – 187
Critical Point Apparatus	U104001	138
Critical Potential Tube S with He-Filling	U18560	256 – 257
Critical Potential Tube S with Ne-Filling	U18565	256 – 257
Crocodile Clips 4mm, Not Insulated, Set 10	U13821	299
Crocodile Clips on 3B Box	U29527	200 – 201
Crookes Radiometer	U14300	135
Cross Bosshead	U13256	297
Crosspiece DN 16 KF	U14511	93
Crown Glass Prism 60°, 27x50 mm	U140001	166
Crown Glass Prism 60°, 30x30 mm	U14051	166
Crown Glass Prism 60°, 45x50 mm	U14005	166
Crown Glass Prism 90°, 30x50 mm	U14010	166
Crown Glass Prism 90°, 45x50 mm	U14015	166
Crystallography Accessories	U19206	258b
CT Controller	U10631	119
CT Measuring Trough	U10633	119
CT Sample	U10632	119
CT Scanner	U10630	119
Cubes for Determining Density, Set of 7	U8404509	85
Current Balance Equipment Set	U17209	222
Current Direction Indicator in 3B Box	U29805	200 – 201
Cuvette Cells, 4 ml, Set of 100	U101601	181
Cuvette, Rectangular, 80x30x80 mm^3	U8475830	302
Cyclic Processes	–	141 – 145
Cylinders, Equal in Mass, Set of 3	U8403325	84
Cylinders, Equal in Volume, Set of 3	U8403315	84
Cylinders, Set of 3	U10026	115
Cylindrical Bar Magnet 200x10	U20550	214
Cylindrical Bar Magnet 50x20	U8495210	214
- D -	–	–
Daniell Cell	U14331	212
Darlington-Transistor TIP162, P4W50	U333114	209
DC Power Supply 0 – 16 V, 0 – 10 A (115 V, 50/60 Hz)	U11705-115	270
DC Power Supply 0 – 16 V, 0 – 10 A (230 V, 50/60 Hz)	U11705-230	270

Description	Art. No.	Page	Description	Art. No.	Page
DC Power Supply 0 – 16 V, 0 – 16 A	U117361	270	Digital-Spectrometer HD	U22029	180 – 181
DC Power Supply 0 – 20 V, 0 – 5 A (115 V, 50/60 Hz)	U33020-115	270	Digital-Spectrometer LD	U22028	180 – 181
DC Power Supply 0 – 20 V, 0 – 5 A (230 V, 50/60 Hz)	U33020-230	270	DIN-B Burette with Schellbach Stripe, 10 ml	U14224	195, 302
DC Power Supply 0 – 300 V (115 V, 50/60 Hz)	U8521371-115	271	Diode D	U191501	234
DC Power Supply 0 – 300 V (230 V, 50/60 Hz)	U8521371-230	271	Diode in 3B Box	U29529	200 – 201
DC Power Supply 0 – 32 V, 0 – 2.5 A (115 V, 50/60 Hz)	U11710-115	270	Diode Laser 1000 mW	U14022	184 – 187
DC Power Supply 0 – 32 V, 0 – 2.5 A (230 V, 50/60 Hz)	U11710-230	270	Diode S	U185501	239
DC Power Supply 0 – 500 V (115 V, 50/60 Hz)	U33000-115	271	Displacement Sensor	U11371	41
DC Power Supply 0 – 500 V (230 V, 50/60 Hz)	U33000-230	271	DMM 1000 Iso-Multimeter	U11277	282
DC Power Supply 1.5 – 15 V, 1.5 A (230 V, 50/60 Hz)	U8521121-230	269	DMM50 Digital Multimeter	U11276	282
DC Power Supply 450 V (115 V, 50/60 Hz)	U8521400-115	269	DMM60 Digital Multimeter	U11275	282
DC Power Supply 450 V (230 V, 50/60 Hz)	U8521400-230	269	Doppler Phantom Fluid	U10004	116
DC Power Supply, 1 – 32 V, 0 – 20 A (115 V, 50/60 Hz)	U11827-115	270	Doppler Prisms and Flow Tubes, Set	U10002	118
DC Power Supply, 1 – 32 V, 0 – 20 A (230 V, 50/60 Hz)	U11827-230	270	Doppler Sonography	–	117 – 118
Demonstration Aneroid Barometer	U10260	122	d-Orbitals, Set of 5	U40014	250
Demonstration Dynamo	U30066	225	Dosimeter Radex RD 1706	U8557150	260
Demonstration Gratings	U19520	162	Double Slits on Glass Plate	U22014	164
Demonstration Polarimeter	U14390	174	Doubly Refracting Crystal	U8500944	167
Demonstration Polaroscope	U8472580	174	Drawing Instruments for Whiteboard, Set	U10045	295
Demonstration Thermometer -10 – 110°C	U16120	124 – 125	Drilled Rod	U11055	298
Demonstration Tuning Fork	U55001	108	Drop and Launch Apparatus	U119831	70
Demonstration Wave Machine, Complete Set	U45011	102	Dry Fuel for Steam Engine B	U13851	145
Demonstration Wave Machine, Single Module	U45012	102	Dual Beam Tube S	U18570	240
Demountable Transformer	–	228 – 230	Dual-Beam Tube D	U19170	235
Density and Volume	–	84 – 85	Dummy Flange DN 16 KF	U14514	93
Density Bodies, Set of 5	U8404556	83	Dynamometer 1 kg / 10 N, Colour Coded	U40812	52
Density Paradox Set	U45056	84	Dynamometer 1 N, Transparent	U11010	52
Device for Archimedes' Principle	U40875	83	Dynamometer 1 N, with Round Dial	U8402501	52
Device for Demonstrating the Anomaly of Water	U14318	132	Dynamometer 10 N, with Round Dial	U8402510	52
Diac, BR 100, P2W19	U333081	207	Dynamometer 2 kg / 20 N, Colour Coded	U40813	52
Diaphragm with 2 cross gratings	U14106	163	Dynamometer 2 N, Transparent	U11011	52
Diaphragm with 3 Circular Holes and Disc Pairs	U14108	163	Dynamometer 2 N, with Round Dial	U8402502	52
Diaphragm with 3 Double Slits of Different Widths	U14100	163	Dynamometer 250 g / 2.5 N, Colour Coded	U40810	52
Diaphragm with 3 ruled gratings	U14103	163	Dynamometer 3 kg / 30 N, Colour Coded	U40814	52
Diaphragm with 3 Single Slits and 1 Double Slit	U8476600	162	Dynamometer 5 kg / 50 N, Colour Coded	U40815	52
Diaphragm with 4 Double Slits of Different Spacings	U14101	163	Dynamometer 5 N, Transparent	U11012	52
Diaphragm with 4 Multiple Slits and Gratings	U14102	163	Dynamometer 5 N, with Round Dial	U8402505	52
Diaphragm with 9 Circular Discs	U8476655	163	Dynamometer 500 g / 5 N, Colour Coded	U40811	52
Diaphragm with 9 Circular Holes	U8476665	163	Dynamometer 6 N, Transparent	U11013	52
Diaphragm with a Single Slit and Rib	U14107	162	Dynamometers for Demonstrating Hooke's Law	U20037	53
Diffraction Apertures on Glass Plate	U22011	164	– E –		
Diffraction Elements, Optical	–	162 – 164	E 10 Lamp Socket, Sideways Facing, P2W19	U333094	209
Diffraction Gratings on Glass Plate	U22026	164	E 10 Lamp Socket, Upwards Facing, P2W19	U333095	209
Diffraction Tube S	U185711	240	E10 Lamp Socket on 3B Box	U29510	200 – 201
Digital Callipers, 150 mm	U10072	50	E10 Lamp Sockets, Set of 10	U29509	199
Digital Counter (115 V, 50/60 Hz)	U8533341-115	49, 259, 284	E14 Lamp Socket on Stem	U8473200-230	156
Digital Counter (230 V, 50/60 Hz)	U8533341-230	49, 259, 284	E27 Lamp Socket on Stem	U8473210-230	156
Digital Counter with Interface (115 V, 50/60 Hz)	U210051-115	285	ECG/EMG Box	U11396	44
Digital Counter with Interface (230 V, 50/60 Hz)	U210051-230	285	Ecoflam Pellets, Set of 60	W13654	291
Digital Counters	–	284 – 285	Elastic Balls with Plotting Electrode, Pair	U8405630	66
Digital Energy Meter	U118261-230	283	Elastic Deformation	–	89
Digital Hygro-Thermometer	U16102	122	Elastic Modulus	–	89
Digital Input Box	U11377	46	Electric Doorbell	U21854	91
Digital Luxmeter	U11803	283	Electric Field Meter (115 V, 50/60 Hz)	U8533015-115	196
Digital Mini Multimeter	U118071	280	Electric Field Meter (230 V, 50/60 Hz)	U8533015-230	196
Digital Multimeter E	U8531050	281	Electric Motor and Generator, Complete	U8481531	224
Digital Multimeter P1035	U11806	280	Electrical Burner LAB2 (230 V, 50 Hz)	W13650-230	291
Digital Multimeter P3320	U118082	281	Electrical Burner LAB3 (230 V, 50 Hz)	W13651-230	291
Digital Multimeter P3340	U118091	280	Electrical Circuits	–	198 – 205
Digital Multimeter P3415	U118241	281	Electricity and Magnetism	–	192 – 245
Digital Oscilloscope 4x60 MHz	U22060	276 – 277	Electrochemistry	–	211 – 213
Digital Output Box	U11376	46	Electrochemistry Case	U11110	211
Digital Pocket Anemometer	W13623	123	Electrochemistry, Equipment Set for	U11100	213
Digital Pocket Thermometer	U40173	126	Electrodes for ECG/EMG, Set of 30	U11398	44
Digital Quick Response Pocket Thermometer	U11853	124 – 125	Electrolytic Trough	U51001	195
Digital Spectrometer LD with Absorption Chamber	U22031	180 – 181	Electromagnetic Launch Apparatus	U20611	62 – 63
Digital Stopwatch	U11902	49	Electromagnetism, Equipment Set	U10371	222 – 223
Digital Stroboscope (115 V, 50/60 Hz)	U40160-115	285	Electrometer (115 V, 50/60 Hz)	U8531408-115	194
Digital Stroboscope (230 V, 50/60 Hz)	U40160-230	285	Electrometer (230 V, 50/60 Hz)	U8531408-230	194
Digital Thermometer, 1 Channel	U11817	127	Electrometer Accessories	U8531420	194
Digital Thermometer, 2 Channels	U11818	127	Electrometer Box	U11375	43
Digital Thermometer, Min/Max	U16101	126	Electron Deflection Tube D	U19155	232
Digitale Oscilloscope, 2x100MHz	U11167	276 – 277	Electron Diffraction Tube D	U191711	232
Digitale Oscilloscope, 2x25MHz	U11165	276 – 277	Electron Tubes	–	232 – 245
Digitale Oscilloscope, 2x40MHz	U11166	276 – 277	Electronic Scale 200 g	U42060	288
			Electronic Scale 5000 g	U42061	288
			Electronic Scale Scout Pro 200 g	U42048-230	289
			Electronic Scale Scout Pro 400 g	U42049-230	289
			Electronic Scale Scout Pro 600 g	U42050-230	289
			Electroscope	U17250	193
			Electroscope S	U8557120	193
			Electrostatic Equipment Set	U8491500	192
			Electrostatics	–	192 – 197
			ELV Motor on 3B Box	U29530	200 – 201
			Energy and the Environment	–	120 – 123
			Equipment Kit "Hysteresis Curve"	U8557500	215
			Equipment Set "Ultrasound in Solids"	U10020	114
			Equipment Set Electromagnetism	U10371	222 – 223
			Equipment Set for Colour Mixing	U21883	171
			Equipment Set for Electrochemistry	U11100	213
			Equipment Set for Laser Communication	U17305	189
			Equipment Set for Powder Tracing	U8400870	66

Description	Art. No.	Page
Equipment Set for Wave Optics with Laser	U17303	169
Equipment Set for Waveguide Optics	U17304	189
Equipment Set Optics with Laser Ray Box	U17300	148
Equipment Sets for Optics	–	188 – 189
Equivalent of Heat	–	128
ESCOLA	–	279
ESR Supplementary Set	U188501	262 – 263
ESR/NMR	–	262 – 263
ESR/NMR Basic Set (115 V, 50/60 Hz)	U188031-115	262 – 263
ESR/NMR Basic Set (230 V, 50/60 Hz)	U188031-230	262 – 263
Exp.: Simple Electric Circuit	UL29510	200 – 201
Experiment Lead, Plug and Socket	U13760	299
Experiment Lead, Safety Plug and Socket	U13761	299
Experiment leads and cables	–	299 – 301
Experiment Leads for Electron Tube	–	–
Experiments, Set of	U138101	299
Experiment Leads, 75 cm, 1 mm ² , Set of 15	U13800	299
Experiment Leads, 75 cm, 2.5 mm ² , Set of 15	U13801	299
Experiment Leads, 75 cm, Pair	U13813	299
Experiment Motor with Gearbox	U10375	227
Experiment Set Pulleys and Block and Tackle	U30028	59
Experimental Lamp, Halogen	U17140	155
Experiments, Set	U8404260	94
Extension Arm D	U10331	155
External Centring Ring DN 10/16 KF	U14518	93
External Micrometer	U10070	50
Extra Pulley	U52011	57
Eye and Vision	–	191
– F –	–	–
Falling Sphere Viscometer	U14260	88
Faraday Cup	U8496460	194
FET Transistor, BF 244, P4W50	U333086	208
Field Coil 100 mm	U12252	220
Field Coil 120 mm	U12253	220
Filmpack 2	U19209	258h
Filmpack 4	U19210	258h
Filter BG40	U140471	184 – 187
Filter RG850	U14046	184 – 187
Filters, Optical	–	165
Fine Beam Tube on Connection Base	U8481430	244
Fine Beam Tube T	U18575	245
Fishing Line, 10 m	U8557460	295
Flat Coil in a Rotatable Frame	U8496320	225
Flat Coils, Pair	U8495185	218
FlexCam® 2	U42102	292 – 293
Flexible Magnetic Field Sensor	U8533999	286
Flint Glass Block for Faraday Effect	U8474060	168
Flint Glass Prism 60°, 30x30 mm	U14052	166
Fluorescence of Sodium	–	258
Fluorescence Samples, Set	U40206	258h
Fluorescence Samples, Set of	U40206	258h
f-Orbitals, Set of 7	U40016	250
Force Sensor, ±50 N	U11354	41
Force Table	U52004	57
Foucault Pendulum (115 V, 50/60 Hz)	U8403000-115	80
Foucault Pendulum (230 V, 50/60 Hz)	U8403000-230	80
Franck-Hertz Tube with Hg	U8482170	254 – 255
Franck-Hertz Tube with Mercury Filling and Heating Chamber (115 V, 50/60 Hz)	U8482550-115	254 – 255
Franck-Hertz Tube with Mercury Filling and Heating Chamber (230 V, 50/60 Hz)	U8482550-230	254 – 255
Franck-Hertz Tube with Ne	U8482240	254 – 255
Franck-Hertz Tube with Ne Filling on Base	U8482230	254 – 255
Franck-Hertz-Experiment	–	254 – 257
Free Electrons in Gases and in Vacuum	–	232 – 245
Free Fall Apparatus	U8400830	67
Free Fall Tube	U8422090	67
Free Standing Cylinder, without Graduation	U14206	302
Frequency Doubling Module	U14026	184 – 187
Fresnel Biprism	U14053	167
Fresnel Mirror Experiment Set	U17308	160
Fresnel Mirror K	U8476515	150 – 151
Fresnel Mirror on Stem	U10345	160
Friction Measuring Apparatus	U8405120	58
Friction Rods	U11053	194
Frosted Disc	U287050	161
Frosted Disc with "d"	U287020	161
Fuel Cell Demonstration System	U109501	120
Fuel Cell Experiment System	U109552	36
Fuel Cells	–	120
Function Generator 0.02 Hz – 2 MHz (230 V, 50/60 Hz)	U11230-230	274
Function Generator FG 100 (115 V, 50/60 Hz)	U8533600-115	272
Function Generator FG 100 (230 V, 50/60 Hz)	U8533600-230	272
Function Generator SG 10 (230 V, 50/60 Hz)	U8498288-230	273
Function Generator SG10 (115 V, 50/60 Hz)	U8498288-115	273
Function Generators	–	272 – 274
Functional Model of the Eye	W16003	191
Fundamentals of Atomic Physics	–	252 – 253
Funhouse Mirror 135x210cm ²	U40275	190

Description	Art. No.	Page
Funhouse Mirror 60x130cm ²	U40276	190
Fuse Holder on 3B Box	U29526	200 – 201
Fuses, Set of	U11269	300
Fusion Ring	U8497310	229
– G –	–	–
Galvanometer, DC	U11814	278
Gas Discharge Tube	U14380	242
Gas Discharge Tube S	U18580	242
Gas Expansion Apparatus	U58030	132
Gas Filled Photocell	U8482445	253
Gas Laws	–	137 – 140
Gas Triode D	U19157	234
Gas Triode S with He-Filling	U18557	239
Gas Triode S with Ne-Filling	U18558	239
GASTEC Gas Detector	W11730	37
Gauge with Adaptor	U8442250	131
Gay-Lussac Pycnometer	U14220	84
Geared Motor with Pulley	U8498304	31
Geiger Counter	U111511	29, 259
Geiger-Müller Counter Tube	U8533430	259
Geiger-Müller Tube T	U19201	258c
Geometric Optics	–	149
Geometrical Objects on Glass Plate	U22027	161
Equipment Set "Stereophonic Hearing"	U8557320	107
Equipment Set "Sound Propagation in Rods" (115 V, 50/60 Hz)	U8557180-115	107
Equipment Set "Sound Propagation in Rods" (230 V, 50/60 Hz)	U8557180-230	107
Germanium Diode, AA 118, P2W19	U333071	207
Glass Cylinder with 2 Tubes	U14321	87
Glass Inset for Newton's Rings Experiments	U22018	160
Glass Shot, 100 g	U8442640	301
Glassware	–	302
Globe with Bar Magnet	U8495245	216
Glycerine, 250 ml	U8496816	88, 301
Graduated Cylinder, 100 ml	U14205	301, 302
Graduated Cylinder, 250 ml	U29453	302
Graetz Bridge in 3B Box	U29803	200 – 201
Grating 1000/mm	U21874	163
Grating 140/mm	U21871	163
Grating 530/mm	U21872	163
Grating 600/mm	U21873	163
Gratings, Set of 4	U19515	163
Gravitation	–	56
Green LED on 3B Box	U29578	200 – 201
Greenhouse Effect	–	121
Gyroscope	U52006	74
Gyroscopes	–	74
Gyroscope Accessories	U52010	74
Gyroscope S	U8556020	74
– H –	–	–
Hall Effect Basic Apparatus	U8487000	264 – 265
Hall Effect	–	264 – 265
Hall Sensors	–	286
Halogen Lamp 12 V, 20 W	U8475410	150 – 151
Halogen Lamp 500 W (230 V, 50/60 Hz)	U8476713-230	120
Halogen Lamp, 12 V, 35 W	U40122	147
Halogen Lamp, 12 V, 55 W	U40113	146
Hand Spectroscope with Amici Prism	U8472660	178
Hand-Held Analogue Measuring Instruments	–	278 – 279
Hand-Held Digital Measuring Instruments	–	280 – 283
HD Video Flex	W499912	292 – 293
Heart Model	U10029	115
Heat and Thermodynamics	–	124 – 145
Heat Conducting Rod Al	U8498292	136
Heat Conducting Rod Cu	U8498291	136
Heat Conduction	–	136
Heat Conduction Equipment Set	U8498290	136
Heat Conductivity Device	U409051	133
Heat Equivalent Apparatus	U10365	128
Heat Flow	–	134 – 135
Heat Flow Device	U14340	133
Heat Flow Device S	U58031	133
Heat Pump D (115 V, 50/60 Hz)	U8440600-115	144
Heat Pump D (230 V, 50/60 Hz)	U8440600-230	144
Heat Sources	–	291
Heating Chamber (115 V, 50/60 Hz)	U8482590-115	258
Heating Chamber (230 V, 50/60 Hz)	U8482590-230	258
Heating rod K	U8498280	104 – 105
Helical Spring Snakey	U30034	99
Helical Springs 1.5 N/m	U8405840	53
Helical Springs 16 N/m	U11025	53
Helical Springs 2.5 N/m	U8405820	53
Helical Springs 20 N/m, 180 mm	U15028	53
Helical Springs 3.0 N/m	U15027	53
Helical Springs 43 N/m	U11026	53
Helical Springs 5 N/m	U8401010	53
Helical Springs 86 N/m	U11027	53
Helical Springs for Hooke's Law, Set of	U40816	53
Helmholtz Coils 300 mm	U8481500	225, 244
Helmholtz Coils on Mounting Plate, Pair of	U21901	220
Helmholtz Pair of Coils D	U191051	236

Description	Art. No.	Page	Description	Art. No.	Page
Helmholtz Pair of Coils S	U185051	241	Inverting Spectacles	U8476730	167
Helmholtz Resonator d = 32 mm	U8430340	110	Ionisation Chamber	U19208	258h
Helmholtz Resonator d = 40 mm	U8430330	110	IR Detector Card	U10530	184
Helmholtz Resonator d = 52 mm	U8430320	110	Iris Diaphragm K	U8472345	150 – 151
Helmholtz Resonator d = 70 mm	U8430310	110	Iris on Stem	U17010	159
He-Ne Laser	U21840	156	Iron Filings	U11451	218
Hexagonal Magnet Model	U15350	218	Iron Plates, Set of 10	U11103	213
HF Coil, 33 mH, P2W19	U333092	207	Iron Wire 0.3 mm / 100 m	U8495460	198
HF Patch Cord	U11255	301	– J –		
HF Patch Cord, BNC/4 mm Plug	U11257	301	Jet Nozzle (Flow Laminator)	U8404250	94
Hg High-Pressure Spare Lamp (230 V, 50/60 Hz)	U21831-230	177	Jolly's Bulb and Gauge	U10710	140
Hg High-Pressure Spectral Lamp (230 V, 50/60 Hz)	U21827-230	177	Jumpers, P2W19, Set of 10	U333093	209
Hg Low-Pressure Spare Lamp (230 V, 50/60 Hz)	U21832-230	177	– K –		
Hg Low-Pressure Spectral Lamp (230 V, 50/60 Hz)	U21828-230	177	Kater's Reversible Pendulum	U8557170	77
High Current Coil D for Nail Fusing Experiment	U8497406	228	Kirchhoff-Bunsen Spectroscope	U14415	179
High Current Coil S	U8498065	230	Kit Greenhouse Effect (115 V, 50/60 Hz)	U8460500-115	121
High Current Coil with Five Turns	U8497320	229	Kit Greenhouse Effect (230 V, 50/60 Hz)	U8460500-230	121
High Current Sensor, 10 A	U11315	43	Knife-Edge Switch on 3B Box	U29524	200 – 201
High Voltage Coil D Including 2 Horn Shaped Electrodes	U8497460	228	Kolbe's Electroscope	U8532131	193
High Voltage Power Supply 5 kV (115 V, 50/60 Hz)	U33010-115	271	Kröncke Optical System for Student Exercises	–	32 – 33
High Voltage Power Supply 5 kV (230 V, 50/60 Hz)	U33010-230	271	Kröncke Optics	–	150 – 151
High-Pressure Mercury Vapour Lamp	U8473155	177, 253	K-Type NiCr-Ni Immersion Sensor, -200°C – 1150°C	U11855	124 – 125
High-Voltage Cables, 150 cm, Pair	U13814	300	K-Type NiCr-Ni Immersion Sensor, -65°C – 550°C	U11854	124 – 125
High-Voltage Power Supply E 5 kV (115 V, 50/60 Hz)	U8498294-115	271	Kundt's Tube	U8432845	103
High-Voltage Power Supply E 5 kV (230 V, 50/60 Hz)	U8498294-230	271	Kundt's Tube E	U8498308	104 – 105
Historical Experiments	–	303	– L –		
Hofmann's Voltmeter S	U58010	212	Lab Material	–	296 – 302
Hofmann's Voltmeter	U14332	212	Laboratory Jack I	U15022	296
Holder for Components	U8495610	198	Laboratory Jack II	U15020	296
Holder for Glassware	W13653	291	Laboratory Jack III	U15021	296
Holder for Hall Effect	U8557420	265	Laboratory Scales	–	288 – 289
Holder for Light Barrier	U8557210	67	Laminar Flow	–	95
Holder for Magnetic Field Sensor	U8557470	221	Laminar Flow Apparatus	U8404248	95
Holder for Plug-in Components	U8557220	298	Lamp Housing on a Stand Rod	U21906	176
Holder K for Diode Laser	U8475550	150 – 151	Lamp Socket E10 on Acrylic Base	U8495310	198
Holder on Stem for Direct-Vision Prism	U8474050	159	Lamp Socket E14 on Acrylic Base	U8495320	198
Holder on Stem for Lenses without Frame	U21835	159	Lamp Sockets E10, Set of 10	U29509	199
Hole Diaphragms, Set of 5	U8470800	161	Laser Communication, Equipment Set	U17305	189
Hollow Prism, Equal-Sided	U11922	166	Laser Diode Driver and Temperature Controller	U14021	184 – 187
Hologram	U21870	162	Laser Diode for Debye-Sears Effect, Green	U10009	112
Hook Weights and Thread, Set of	U8557450	63, 295	Laser Diode for Debye-Sears Effect, Red	U10007	112
Horn Loudspeaker	U8432680	111	Laser Diode, Red	U22000	156
Horseshoe Magnet 130 mm, with Yoke	U20570	214	Laser Mirror	U14028	184 – 187
Horseshoe Magnet 140 mm, with Yoke	U19553	214	Laser Mirror HAT, 532 nm	U14029	184 – 187
Horseshoe Magnet, 70 mm	U8491810	214	Laser Module, Green	U22001	156
Human Pulse Sensor Box	U11392	44	Laser Ray Box (115 V, 50/60 Hz)	U17302-115	148
Humidity Sensor	U11336	43	Laser Ray Box (230 V, 50/60Hz)	U17302-230	148
Hydraulic/Pneumatic Lifting Platform	U45053	86	Laser Reflection Sensor	U8533380	40, 49
Hysteresis Curve, Equipment Kit	U8557500	215	Laser Safety Goggles for Nd:YAG Laser	U14085	184
– I –			Launch Apparatus, Electromagnetic Launcher S	U20611	62 – 63
Ice Bomb	U8442120	130	Leclanché Cell	U8400930	69
Image Objects, Set of 4	U8476605	161	LED Graetz Bridge in 3B Box	U14330	213
Immersion Block Al 100 cm ³	U15037	84	LED Infra-red, Sideways Facing, P2W19	U29804	200 – 201
Immersion Block Al 50 cm ³	U15036	84	LED, Green, Upward Facing, P2W19	U333108	207
Immersion Block Fe 100 cm ³	U15039	84	LED, Red, Sideways Facing, P2W19	U333079	207
Immersion Block Fe 50 cm ³	U15038	84	LED, Red, Upward Facing, P2W19	U333080	207
Immersion Heater (230 V, 50/60 Hz)	U8624110-230	291	LED, Yellow, Upward Facing, P2W19	U333070	207
Immersion Heater, 12V	U30075	129	LED, Yellow, Upward Facing, P2W19	U333107	207
Immersion/Circulation Thermostat (115 V, 50/60 Hz)	U144002-115	139	Lenz's Law Copper Tube	U30086	227
Immersion/Circulation Thermostat (230 V, 50/60 Hz)	U144002-230	139	Lenz's Law Apparatus	U8556012	227
Inclination Instrument E	U8495258	217	Leslie Cube with Heater (115 V, 50/60Hz)	U8498299-230	135
Inclination Instrument	U21900	217	Leslie Cube with Heater (230 V, 50/60Hz)	U8498299-115	135
Inclined Plane	U30015	60	Leslie's Cube	U8442835	134
Indigo Solution	U8410620	87, 301	Lever	U8552001	60
Inductance Decades	U118201	204	Light and Optics	–	146 – 191
Induction	–	224 – 227	Light Box	U30011	35
Induction Apparatus	U8496270	224	Light Emitting Diodes for Determination of h	U8482460	252
Induction Coils, Set of 3	U122501	226	Light Metal Tuning Fork, 1000 Hz	U10116	108
Inertia Balance	U30045	77	Light Metal Tuning Fork, 1700 Hz	U10115	108
Infra-red Temperature and Humidity Gauge	U11819	122	Light Sensor	U11364	44
Infra-red Thermometer, 380° C	U118161	127	Linear Expansion Apparatus D	U15400	131
Infra-red Thermometer, 800° C	U118152	127	Linear Expansion Apparatus S	U15405	131
Insertion Thermometer	U40170	126	Linear Expansion Apparatus with Three Pointers	U8442200	131
Insertion Thermometer F	U29627	126	Linear Motion	–	61 – 63
Instrumentation	–	266 – 295	Lip Whistle	U8430185	110
Insulator with Clamp	U15321	199	Lodestone	U19557	215
Interference Filter 436 nm	U22020	165	Loop-Shaped Conductor on Acrylic Base	U8491792	219
Interference Filter 546 nm	U22019	165	Lorentz Force Apparatus	U30065	222
Interference Filter 578 nm	U22021	165	Lorentz Motor	U10372	222 – 223
Interferometer	U10350	183	Low Temperature Stirling Engine Assembly Kit	U10061	143
Interferometers	–	182 – 183	Low Voltage Coil D	U8497410	228
			Low-Frequency Transformer, 1:2, P4W50	U333090	208
			Low-Temperature Stirling Engine	U10060	143
			Luminescence Tube D	U19152	233
			Luminescence Tube S	U18552	238

Description	Art. No.	Page
– M –		
Mach-Zehnder-Interferometer	U10353	182
Magdeburg Hemispheres	U30010	90
Magdeburg Plates	U45054	90
Magic Mirror	U300001	303
Magnet Model, Cubic	U15351	218
Magnetic Equipment Set	U19555	214
Magnetic Field Indicator	U8491900	216
Magnetic field line apparatus, Two-Dimensional	U19560	218
Magnetic Field Lines Device, Three-Dimensional	U8491925	218
Magnetic Field Sensor ± 100 mT	U11360	42
Magnetic Field Sensor ± 2000 mT	U11359	42
Magnetic Field Sensor, Axial/Tangential	U8533997	286
Magnetic Fields	–	216 – 221
Magnetic Fields, Set of Apparatus for Displaying	U8491790	219
Magnetic Holder for Single-Ray Projector	U40121	147
Magnetic Needle, 80 mm	U216031	217
Magnetic Pucks, Pair	U40515	65
Magnetic Stirrer	U11876	290
Magnetic Stirrer 12L (230 V, 50/60 Hz)	U29025	290
Magnetic Stirrer with Heater (115 V, 50/60 Hz)	U11875-115	290
Magnetic Stirrer with Heater (230 V, 50/60 Hz)	U11875-230	290
Magnetic Stirrers	–	290
Magnetism	–	214 – 223
Magnetising Coil	U30048	220
Magnets	–	214
Mains Coil D with Connecting Lead (115 V, 50/60 Hz)	U8497420-115	228
Mains Coil D with Connecting Lead (230 V, 50/60 Hz)	U8497420-230	228
Maltese Cross Tube D	U19153	233
Maltese Cross Tube S	U18553	238
Marble in a Bowl	U8498293	71
Mariotte Flask	U14327	140
Maximum Minimum Thermometer	U29563	122
Maxwell's Wheel	U8408305	70
Measurement Amplifier (115 V, 50/60 Hz)	U8531401-115	287
Measurement Amplifier (230 V, 50/60 Hz)	U8531401-230	287
Measurement of Length	–	50
Measurement of Time	–	49
Measurement of Volume	–	51
Measuring Amplifier S	U8532161	287
Mechanical Balance 311	U42010	288
Mechanical Balance 610	U42000	288
Mechanical Cumulative Stopwatch	U11901	49
Mechanical Stopwatch, 15 min	U40801	49
Mechanical Stopwatch, 30 min	U40800	49
Mechanical Waves	–	99 – 102
Mechanics	–	48 – 95
Mechanics Kit for Whiteboard	U8400040	48
Mechanics on a Whiteboard	–	48
Metal Bridge	U17206	83
Metal Ring	U8497470	229
Metal Strips, Set of 5	U8497330	229
Metallophone	U8430290	110
Michelson Interferometer	–	183
Micrometer Screw K	U8476630	150 – 151
Micromotor, 1.5 V DC, P2W19	U333103	207
Microphone	U11367	41
Microphone probe, long	U8498282	104 – 105
Microphone probe, short	U8498307	104 – 105
Microscopes	–	294
Microsecond counter (115 V, 50/60 Hz)	U8498285-115	106
Microsecond Counter (230 V, 50/60 Hz)	U8498285-230	106
Microstructures on Glass Plate	U22025	164
Microvoltmeter (115 V, 50/60 Hz)	U8530501-115	287
Microvoltmeter (230 V, 50/60 Hz)	U8530501-230	287
Microwave Set 10.5 GHz (115 V, 50/60 Hz)	U8493600-115	96 – 97
Microwave Set 9.4 GHz (230 V, 50/60 Hz)	U8493600-230	96 – 97
Millikan's Apparatus (115 V, 50/60 Hz)	U20700-115	251
Millikan's Apparatus (230 V, 50/60 Hz)	U20700-230	251
Millikan's Experiment	–	251
Millikan's Oil Drop Experiment	–	251
Millisecond Counter (115 V, 50/60 Hz)	U8533370-115	285
Millisecond Counter (230 V, 50/60 Hz)	U8533370-230	285
Model Crystals	–	248
Model Eye for Ultrasonic Biometry	U10018	116
Model of a Human Eye, 6-Piece	F15	191
Molecule Building Sets	–	249
Moll-Type Thermopile	U8441301	121, 134
Momentary Contact Switch on Acrylic Base	U8495930	198
Monochord	U8431216	110
Monochord D	U15100	110
Monochord Strings, Set of 3	U15101	110
Monocular Course Microscope Model 100 (230 V, 50/60 Hz)	W30600-230	294
MoS ₂ Sample	U13914	247
Motion in a Plane	–	64 – 66

Description	Art. No.	Page
Motor Drive Debye-Scherrer (230 V, 50/60 Hz)	U192021-230	258b
Motor with Drive Control	U11040	170
Motor, 12 V DC	U8552330	101
Multimeter	–	278 – 283
Multiple Ray Projector, Magnetic	U40110	146
Multiple Slits on Glass Plate	U22015	164
– N –		
Na Low-Pressure Spare Lamp (230 V, 50/60 Hz)	U21833-230	177
Na Low-Pressure Spectral Lamp (230 V, 50/60 Hz)	U21829-230	177
Nal Operating and Evaluation Unit	U46010	261
Nal(Tl) Scintillation Detector	U46000	261
Nails for Nail Fusing Experiment, Set of 20	U8497331	229
Nd:YAG Module	U14025	184 – 187
N-Doped Germanium on Printed Circuit Board	U8487030	264 – 265
NEVA Optical System	–	152
Newton's Colour Disc	U15500	170
Newton's Colour Disc, with Crank	U29587	170
Newton's Colour Disc, with DC Motor	U29555	170
Nickel Plates, Set of 5	U11104	213
Nickel Wire 0.3 mm / 50 m	U8495490	198
NMR	–	262 – 263
NMR Supplementary Set	U189021	262 – 263
Noise	–	123
Noise Level Indicator SPL	U10610	123
Noise Level Meter P8005	U11804	283
NPN Transistor BC140, P4W50	U333112	208
NPN Transistor, BC 550, P4W50	U333084	208
NPN Transistor, BD 137, P4W50	U333082	208
NTC Resistor, 2.2 k Ω , P2W19	U333049	207
– O –		
Object for Measurement Exercises	U8404550	51
Object Holder N	U8470350	152
Object Holder on Stem	U8474000	158
Objective for Beam Divergence	U22002	156
Oersted's Needle Device	U29310	215
Ohm's Law Apparatus in 3B Box	U29806	200 – 201
Oil for Millikan Apparatus, 50ml	U13109	251
Oil for Steam Engine	U13852	145
Operating Unit for Fine-Beam Tube	U8481425	245
Operational Amplifier, LM 741, P4W50	U333089	208
Optical Apertures	–	161 – 165
Optical Base D	U10319	155
Optical Bench K, 1000 mm	U8475240	150 – 151
Optical Bench K, 2000 mm	U8475260	150 – 151
Optical Bench K, 500 mm	U8475230	150 – 151
Optical Bench KL	U14040	184 – 187
Optical Bench N	U8470465	152
Optical Bench U, 1200 mm	U17150	153
Optical Bench U, 600 mm	U17151	153
Optical Components on Stem	–	157 – 159
Optical Components, Set	U15530	149
Optical Crystals	–	166 – 167
Optical Diffraction Elements	–	162 – 164
Optical Disc with Accessories	U17128	153
Optical Disc with Diode Laser (115 V, 50/60 Hz)	U17307-115	149
Optical Disc with Diode Laser (230 V, 50/60 Hz)	U17307-230	149
Optical Equivalent to Debye-Scherrer Interference	U19172	236
Optical Filters	–	165
Optical Lamp K	U8475400	150 – 151
Optical Lamp N (115 V, 50/60 Hz)	U8478090-115	152
Optical Lamp N (230 V, 50/60 Hz)	U8478090-230	152
Optical Lamp with Pinhole Aperture	U10354	182
Optical Lamp, Halogen	U21881	155
Optical Lamps on Stem	–	156
Optical Precision Bench D, 100 cm	U10300	154
Optical Precision Bench D, 200 cm	U10301	154
Optical Precision Bench D, 50 cm	U10302	154
Optical Rider D, 120/36	U103171	154
Optical Rider D, 120/50	U103121	154
Optical Rider D, 60/36	U103151	154
Optical Rider D, 60/50	U103101	154
Optical Rider D, 90/36	U103161	154
Optical Rider D, 90/50	U103111	154
Optical Rider K	U8475350	150 – 151
Optical Rider U, 35 mm	U17161	153
Optical Rider U, 75 mm	U17160	153
Optical Telecommunications	–	188
Optical Telecommunications Equipment Set	U22055	188
Optics Kit for Whiteboard	U14600	146
Optics on a Whiteboard	–	146 – 148
Optics Using an Optical Bench D	–	154 – 155
Optics Using an Optical Bench U	–	153
Optics with Laser Ray Box, Equipment Set	U17300	148
Orbit™ Tellurium	U19600	56
Organic Molecule Set D	W19700	248 – 249
Organic Molecule Set S	W19721	248 – 249
Organic/Inorganic Molecule Set D	W19701	248 – 249

Description	Art. No.	Page	Description	Art. No.	Page
Organic/Inorganic Molecule Set S	W19722	248 – 249	Plug-In Component System	–	206 – 209
Oscillation Tube	U14328	140	Plug-In Power Supply 3 V DC		
Oscillations	–	75 – 82	(100-240 V, 50/60 Hz)	U17309	160
Oscilloscope Probe, 100 MHz	U11800	274	Plug-In Power Supply, 12 V AC, 2000 mA		
Oscilloscopes	–	275 – 277	(115 V, 50/60 Hz)	U9004674	266
Outlet Vessel, Metal	U30084	87	Plug-In Power Supply, 12 V AC, 2000 mA		
			(230 V, 50/60 Hz)	U9004673	266
– P –			Plug-In Power Supply, 12 V AC, 500 mA		
Pair of Adaptor Cables 4-mm/2-mm Plug	U10369	128	(115 V, 50/60 Hz)	U8521380	266
Pair of Bar Magnets, 80 mm	U19550	214	Plug-In Power Supply, 12 V AC, 700 mA		
Pair of Bar Magnets, AlNiCo, 60 mm, with			(230 V, 50/60 Hz)	U8521385	266
Two Iron Yokes	U19551	214	Plumb with Line	U15015	57
Pair of Capacitor Plates 125 cm ²	U8492330	197	Pneumatic Lighter	U8741180	140
Pair of Capacitor Plates 250 cm ²	U8492320	197	PNP Transistor BC160, P4W50	U333113	208
Pair of Capacitor Plates 500 cm ²	U8492310	197	PNP Transistor, BC 560, P4W50	U333085	208
Pair of Clamps D	U8497181	230	PNP Transistor, BD 138, P4W50	U333083	208
Pair of Elastic Balls with Plotting Electrode	U8405630	66	Pockels Cell on Stem	U8557250	173
Pair of Experiment Leads, 75 cm	U13813	299	Pockels Effect	–	173
Pair of Flat Coils	U8495185	218	Pocket Measuring Tape, 2 m	U10073	50
Pair of Helmholtz Coils on Mounting Plate	U21901	220	Pocket Spectroscope	U19500	178
Pair of High-Voltage Cables, 150 cm	U13814	300	Pocket Thermometer -10 – 110°C	U14297	124 – 125
Pair of Magnetic Pucks	U40515	65	Pohl's Torsion Pendulum	U15040	81
Pair of Polarsation Filters K	U8476526	150 – 151	Polarimeter	U33400	175
Pair of Pole Shoes and Clamping Brackets D			Polarimeter Tube 100 mm	U33401	175
for Hall Effect	U8497205	230	Polarimeter Tube 200 mm	U33402	175
Pair of Pole Shoes D	U8497200	230	Polarimeter with 4 LEDs (115 V, 50/60 Hz)	U8761161-115	174
Pair of Rail Supports	U171661	153	Polarimeter with 4 LEDs (230 V, 50/60 Hz)	U8761161-230	174
Pair of Reflection Blocks with Delay Path	U100251	114	Polarisation	–	174 – 175
Pair of Safety Experiment Leads, 75 cm, Black	U13812	300	Polarisation Filter (Glass)	U40129	162
Pair of Safety Experiment Leads, 75cm, Red	U13817	300	Polarisation Filter on Stem	U22017	158
Pair of Safety Experiment Leads, 75cm, Red/Blue	U13816	300	Polarisation Filters K, Pair	U8476526	150 – 151
Pair of Tuning Forks, 440 Hz, on			Pole Shoe Fitting D	U8497220	230
Pair of Tuning Weights	U10119	109	Pole Shoes and Clamping Brackets for		
Paraffin Prism	U8557290	97	Hall Effect, Pair	U8497205	230
Parallel Light Optical Lamp N			Pole Shoes D, Pair	U8497200	230
(115 V, 50/60 Hz)	U8478080-115	152	Polyoxymethylene Test Block with		
Parallel Light Optical Lamp N			Protractor Scale	U10023	114
(230 V, 50/60 Hz)	U8478080-230	152	p-Orbitals, Set of 3	U40012	250
Pascal's Pressure Sphere	U14325	86	Potentiometer 1 k Ω , 1 W, P4W50	U333044	208
Pascal's Vane Apparatus	U15070	86	Potentiometer 10 k Ω , 1 W, P4W50	U333045	208
P-Doped Germanium on Printed Circuit Board	U8487020	264 – 265	Potentiometer 100 k Ω , 1 W, P4W50	U333047	208
Pendulum Bobs, Set of 4	U30035	75	Potentiometer 220 Ω , 3 W, P4W50	U333042	208
Pendulum Rod	U8404280	75	Potentiometer 4.7 k Ω , 1 W, P4W50	U333046	208
Pendulum Rod with Angle Sensor			Potentiometer 470 Ω , 1 W, P4W50	U333043	208
(115 V, 50/60 Hz)	U8404275-115	75	Powder Tracing, Equipment Set	U8400870	66
Pendulum Rod with Angle Sensor			Power Function Generator (115 V, 50/60 Hz)	U8533510-115	272
(230 V, 50/60 Hz)	U8404275-230	75	Power Function Generator (230 V, 50/60 Hz)	U8533510-230	272
Pendulum with Plotting Electrode	U8405640	66	Power Supplies	–	266 – 271
Periodic Table of the Elements	–	246	Power Supply Unit for Franck-Hertz		
Periodic Table of the Elements, with			Experiment (115 V, 50/60 Hz)	U8482530-115	254 – 257
Electron Configurations	U197001	246	Power Supply Unit for Franck-Hertz		
Periodic Table of the Elements, with Pictures	U197051	246	Experiment (230 V, 50/60 Hz)	U8482530-230	254 – 257
Permanent Magnet with Adjustable			Precision Dynamometer 0.1 N	U20030	52
Pole Spacing	U10370	222 – 223	Precision Dynamometer 0.2 N	U20031	52
Perrin Tube D	U19154	233	Precision Dynamometer 1 N	U20032	53, 58
Perrin Tube S	U18554	238	Precision Dynamometer 10 N	U20035	53, 58
pH Combined Electrode	U11111	211	Precision Dynamometer 100 N	U20038	52
pH Sensor	U11350	45	Precision Dynamometer 2 N	U20033	53, 58
Photo Gate	U11365	40, 49	Precision Dynamometer 20 N	U20036	52
Photo Gate Holder for Projectile Launcher	U10363	69	Precision Dynamometer 5 N	U20034	52
Photogate Holder for Pendulum	U8403955	76	Precision Dynamometer 5 N	U14293	122
Photoresistor, LDR 05, P2W19	U333048	207	Precision Hair Hygrometer	U51007	202
Phototransistor BPX43, P2W19	U333110	207	Precision Resistor 1 k Ω	U51010	202
Photovoltaics	–	30 – 31	Precision Resistor 1 M Ω	U51004	202
Physical Eye Model	W11851	191	Precision Resistor 1 Ω	U51008	202
Picket Fence	U11366	40	Precision Resistor 10 k Ω	U51011	202
Piezoelectric Charge Source	U8490210	193	Precision Resistor 10 M Ω	U51005	202
PIN Photodiode DET 10 A/M	U14039	184 – 187	Precision Resistor 10 Ω	U51009	202
PIN Photodiode DET 36 A/M	U14038	184 – 187	Precision Resistor 100 k Ω	U51006	202
Pirani Vacuum Gauge (230 V, 50/60 H)	U145051	93	Precision Resistor 100 Ω	U51013	202
Piston Vacuum Pump	U8421210	92	Precision Resistor 300 k Ω	U51030	50
Planck's Constant Apparatus			Precision Sphereometer	–	86
(115 V, 50/60 Hz)	U10700-115	252	Pressure	–	86
Planck's Constant Apparatus			Pressure Balance	U10355	86
(230 V, 50/60 Hz)	U10700-230	252	Pressure Container for Determining		
Plane Mirror	U15510	146	Weight of Air	U8412150	85
Plane Mirror	U21885	302	Pressure Sensor, \pm 100 hPa, Relative	U11321	43
Plane Mirror K	U8475180	150 – 151	Pressure Sensor, \pm 1000 hPa, Relative	U11323	43
Plane Mirror on Stem	U17112	157	Pressure Sensor, 2500 hPa, Absolute	U11320	43
Plane Parallel Plate	U15517	146	Prism Table K	U8476110	150 – 151
Plano Concave Lens, f = -400 mm	U15515	146	Prism Table on Stem	U17020	159
Plano Convex Lens, f = +400 mm	U15516	146	Prisms	–	166 – 167
Plastic Trough	T52006	132, 302	Prisms, Set of 3	U14050	166
Plate Capacitor D	U8492355	197	Probe Microphone @230	U8498283-230	106
Plate Capacitor S	U30040	197	Probe Microphone (115 V, 50/60 Hz)	U8498283-115	106
Plate for Metal Filings	W13655	291	Projectile Launcher	U10360	68
Platinum-Iridium Wire	U13915	247	Projection Screen	U17130	159
Plotter Paper, Set	U405121	65	Projection Screen K, Transparent	U8476310	150 – 151
Plug In Power Supply 24 V, 0.7 A			Projection Screen K, White	U8476320	150 – 151
(115V, 50/60 Hz)	U33200-115	81, 266	Projection Screen N	U84780301	152
Plug In Power Supply 24 V, 0.7 A			Protective Adaptor, 2-Pole	U8557001	236
(230 V, 50/60 Hz)	U33200-230	81, 266	Protective Adaptor, 3-Pole	U8557000	236
Plug-In Board for Components	U33250	206	Psycho-Acoustics	–	107
			PTC Resistor, 100 Ω , P2W19	U333050	207
			Puck Guide	U40510	65

Description	Art. No.	Page
Pulley Block with 1 Pulley	U30020	60
Pulley Block with 2 Pulleys	U30021	60
Pulley Block with 3 Pulleys	U30022	60
Pulley with Table Clamp	U30025	60
Pulleys and Block and Tackle, Experiment Set	U30028	59
Pulse box K	U8498281	106
Push Button Switch (NC) Sing. Pole P2W19	U333097	207
Push Button Switch (NO) Sing. Pole P2W19	U333096	207
Pythagorean Cup	U14350	303
- Q -		
Quincke's Resonance Tube	U8557190	103
Quinhydrone Buffer Solution	U11352	45
- R -		
Radiation Cartridge, 226Ra, 4 kBq	U8483115	29, 260
Radiation of Heat	-	133
Radioactivity	-	259 - 261
Radiography Accessories	U19207	258b
Rail Supports, Pair	U171661	153
Stereophonic Hearing	-	107
Recording Tuning Fork, c 128 Hz	U10110	108
Red LED on 3B Box	U29577	200 - 201
Redox Sensor	U11337	46
Reed Pipe	U8430160	110
Reflection Blocks with Delay Path, Pair of	U100251	114
Reflection Grating	U19525	162
Regenerative energies	-	36
Relative Pressure Sensor, ±100 hPa	U11321	43
Relative Pressure Sensor, ±1000 hPa	U11323	43
Relay	U11368	46
Relay with Change-Over Contact, P4W50	U333100	208
Replacement Circuit Board for Tube Holder S	U99999-611	241
Resistance Apparatus	U8492030	202
Resistance Bridge	U8551002	202
Resistance Decade 1 kΩ	U11183	203
Resistance Decade 1 Ω	U11180	203
Resistance Decade 10 kΩ	U11184	203
Resistance Decade 10 Ω	U11181	203
Resistance Decade 100 Ω	U11182	203
Resistance Decade, 1 Ω - 10 kΩ	U11185	203
Resistor 1 kΩ, 2 W, P2W19	U333024	206
Resistor 1 MΩ, 0.5 W, P2W19	U333040	206
Resistor 1 Ω, 2 W, P2W19	U333011	206
Resistor 1.5 kΩ, 2 W, P2W19	U333025	206
Resistor 10 kΩ, 0.5 W, P2W19	U333030	206
Resistor 10 MΩ, 0.5 W, P2W19	U333041	206
Resistor 10 Ω, 10 W, P2W19	U333013	206
Resistor 10 Ω, 2 W, P2W19	U333012	206
Resistor 100 kΩ, 0.5 W, P2W19	U333036	206
Resistor 100 Ω, 2 W, P2W19	U333018	206
Resistor 15 kΩ, 0.5 W, P2W19	U333031	206
Resistor 150 Ω, 2 W, P2W19	U333019	206
Resistor 2.2 kΩ, 2 W, P2W19	U333026	206
Resistor 22 kΩ, 0.5 W, P2W19	U333032	206
Resistor 22 Ω, 2 W, P2W19	U333015	206
Resistor 220 kΩ, 0.5 W, P2W19	U333037	206
Resistor 220 Ω, 2 W, P2W19	U333020	206
Resistor 3.3 kΩ, 2 W, P2W19	U333027	206
Resistor 33 kΩ, 0.5 W, P2W19	U333033	206
Resistor 330 kΩ, 0.5 W, P2W19	U333038	206
Resistor 330 Ω, 2 W, P2W19	U333021	206
Resistor 4.7 kΩ, 2 W, P2W19	U333028	206
Resistor 47 kΩ, 0.5 W, P2W19	U333034	206
Resistor 47 Ω, 2 W, P2W19	U333016	206
Resistor 470 kΩ, 0.5 W, P2W19	U333039	206
Resistor 470 Ω, 2 W, P2W19	U333022	206
Resistor 5, 1 Ω, 2 W, P2W19	U333014	206
Resistor 6.8 kΩ, 2 W, P2W19	U333029	206
Resistor 68 kΩ, 0.5 W, P2W19	U333035	206
Resistor 68 Ω, 2 W, P2W19	U333017	206
Resistor 680 Ω, 2 W, P2W19	U333023	206
Resonance Bowl	U30001	303
Resonance Boxes	U10120	109
Resonance Wire, Ring Shaped	U56007	100
Rheostat 1 Ω	U17350	203
Rheostat 10 Ω	U17352	203
Rheostat 100 Ω	U17354	203
Rheostat 1000 Ω	U17356	203
Rheostat 3.3 Ω	U17351	203
Rheostat 33 Ω	U17353	203
Rheostat 330 Ω	U17355	203
Rheostat 3300 Ω	U17357	203
Riders for Rulers, Set	U8401570	50
Right Angled Prism	U15520	146
Ripple Tank PM02	U219101	98
Riser Tubes for Pressure Measurement	U10003	118
Rocker Switch, Single Pole, P2W19	U333098	207
Rod Clamp with Insulator	U8713100	199
Rod Thermometer -10 - 100°C	U8451310	124 - 125
Rotary Vane Vacuum Pump PK 4 D (230 V, 50/60 Hz)	U14501	93
Rotary-Vane Vacuum Pump, One-Stage	U34010	92
Rotary-Vane Vacuum Pump, Two-Stage	U34000	92

Description	Art. No.	Page
Rotating Base for Leslie cube	U8557350	134
Rotating Object Holder on Stem	U17001	158
Rotating System on Air Bed (115 V, 50/60 Hz)	U8405680-115	72
Rotating System on Air Bed (230 V, 50/60 Hz)	U8405680-230	72
Rotation Apparatus	U8405715	73
Rotational Motion	-	72 - 73
Round Cell, 100 mm	U14313	175
Round Cell, 200 mm	U14314	175
Round-Bottomed Flask, 250 ml	U29427	302
Round-Bottomed Flask, 500 ml	U29428	302
Rowland Grating	U14424	162
Rubber Band	U56002	100
Rubber Belt for Van de Graaff Generator	U15301	192
Ruled Gratings	U14104	163
Ruler, 1 m	U8401550	50
- S -		
Safety Crocodile Clips 4 mm, Set of 6	U13820	300
Safety Experiment Leads, 75 cm, Black, Pair of	U13812	300
Safety Experiment Leads, 75 cm, Red, Pair of	U13817	300
Safety Experiment Leads, 75 cm, Red/Blue, Pair of	U13816	300
Safety Experiment Leads, 75 cm, Set of 3	U13818	300
Safety Experiment Leads, 75 cm, Set of 15	U138021	300
Safety Experiment Leads for Free Fall Apparatus, Set of 3	U13811	300
Scanning Tunnelling Microscope	U13910	247
Sound Propagation in Solid Bodies	-	107
Seals, Set of	U10402	139
SEK Base Plate	U8408035	17
SEK Electricity and Magnetism	U8506000	20 - 21
SEK Heat	U8502000	18 - 19
SEK Mechanical Oscillations and Waves (115 V, 50/60 Hz)	U61020-115	24 - 25
SEK Mechanical Oscillations and Waves (230 V, 50/60 Hz)	U61020-230	24 - 25
SEK Mechanics	U8501000	16
SEK Optics (115 V, 50/60 Hz)	U8503000-115	22 - 23
SEK Optics (230 V, 50/60 Hz)	U8503000-230	22 - 23
SEK Power Supply (115 V, 50/60 Hz)	U8498030-115	21
SEK Power Supply (230 V, 50/60 Hz)	U8498030-230	21
SEK Radioactivity	U8504000	28 - 29
SEK Solar Energy (115 V, 50/60 Hz)	U8498301-115	30 - 31
SEK Solar Energy (230 V, 50/60 Hz)	U8498301-230	30 - 31
SEK Ultrasonic Waves (115 V, 50/60 Hz)	U61010-115	26 - 27
SEK Ultrasonic Waves (230 V, 50/60 Hz)	U61010-230	26 - 27
Semi Circular Body, f = +200 mm	U15518	146
Semicircular Cell	U21887	149
Sensor Holder for Stirling Engine G	U11372	141
Sensors	-	40 - 47
Set 10 Crocodile Clips 4mm, Not Insulated	U13821	299
Set 14 Bravais Lattices	U40020	248 - 249
Set of 3 Safety Experimental Leads, 75cm	U13818	300
Set of "Conductors and Non-Conductors"	U8495350	199
Set of 10 Aluminium Plates	U11105	213
Set of 10 Beakers, Low Form	U14210	302
Set of 10 Beakers, Tall Form	U14211	302
Set of 10 Cast Iron Bolts	U8442110	130
Set of 10 CO ₂ Test Tubes, 0.03 - 1.00% by vol.	W11731	37
Set of 10 CO ₂ Test Tubes, 0.5 - 8.0% by vol.	W11732	37
Set of 10 Copper Plates	U11101	213
Set of 10 E10 Bulbs 12 V, 100 mA	U29512	199
Set of 10 E10 Bulbs 12 V, 500 mA	U29513	199
Set of 10 E10 Bulbs 3.5 V, 150 mA	U29514	199
Set of 10 E10 Bulbs 3.5 V, 200 mA	U29515	199
Set of 10 E10 Bulbs 6 V, 100 mA	U29517	199
Set of 10 E10 Bulbs 6 V, 350 mA	U29516	199
Set of 10 E10 Bulbs, 1.3 V, 60 mA	U29593	199
Set of 10 E10 Bulbs, 3.8 V, 300 mA	U29589	199
Set of 10 E10 Bulbs, 4 V, 40 mA	U29590	199
Set of 10 E10 Bulbs, 6 V, 1 A	U29592	199
Set of 10 E10 Bulbs, 6 V, 50 mA	U29591	199
Set of 10 E10 Lamp Sockets	U29509	199
Set of 10 Iron Plates	U11103	213
Set of 10 Jumpers, P2W19	U333093	209
Set of 10 O ₂ Test Tubes, 6 - 24% by vol.	W11733	37
Set of 10 Pairs of Protective Rubber Stoppers	W11734	37
Set of 10 Tracing Compasses	U19562	217
Set of 10 Watch Glass Dishes, 120 mm	U14201	302
Set of 10 Watch Glass Dishes, 80 mm	U14200	302
Set of 10 Weights, 10 g	U8404710	54
Set of 10 Weights, 20 g	U8404700	54
Set of 10 Weights, 50 g	U8404720	54
Set of 10 Wooden Rulers, 0.5 m	U30042	51
Set of 10 Wooden Rulers, 1 m	U30041	51
Set of 10 Zinc Plates	U11102	213
Set of 100 Balloons	U29496	90
Set of 100 Cuvette Cells, 4 ml	U101601	181

Description	Art. No.	Page	Description	Art. No.	Page
Set of 12 Materials with 4 Different Masses Each	U45058	85	Silicon Diode, BY 255, P2W19	U333069	207
Set of 15 Bodies with 2 Different Densities	U45059	85	Silicon photocell BPY47P, P2W19	U333111	207
Set of 15 Experiment Leads, 75 cm 1 mm ²	U13800	299	Simple Machines	–	59 – 60
Set of 15 Experiment Leads, 75 cm 2.5 mm ²	U13801	299	Sine Wave Generator	U8533550	273
Set of 15 Safety Experiment Leads, 75 cm	U138021	300	Single Breast Model with Benign Tumor	L55/1	116
Set of 1-Litre Bodies	U29812	51	Single Ray Projector	U40120	147
Set of 2 Materials with 4 Different Masses each	U45057	85	Single Slit N	U8470870	152
Set of 20 Nails for Nail Fusing Experiment	U8497331	229	Single Slits, Set of 5	U8470790	162
Set of 3 Areometers	U16106	84	Single-Throw Switch on Acrylic Base	U8495920	198
Set of 3 Carbon Configurations	U40030	248 – 249	Skin Resistance Box	U11393	44
Set of 3 Colour Filters, Primary Colours	U21878	165	Sliding Rider D	U103202	154
Set of 3 Colour Filters, Secondary Colours	U21879	165	Slit and Hole Diaphragms, Set of 5	U17040	161
Set of 3 Conductivity Standards	U11334	45	Slits and Bars on Glass Plate	U22012	164
Set of 3 Cylinders	U10026	115	Slotted Weights, 10 x 10 g, Red and Grey, Set of	U8404760	54
Set of 3 Cylinders, Equal in Mass	U8403325	84	Slotted Weights, 10 x 10 g, Set of	U30031	54
Set of 3 Cylinders, Equal in Volume	U8403315	84	Slotted Weights, 20 – 100 g, Set of	U30030	54
Set of 3 Induction Coils	U122501	226	Slotted Weights, 4 x 100 g, Red and Grey, Set of	U8404785	54
Set of 3 Monochord Strings	U15101	110	Slotted Weights, 5 x 100 g, Set of	U30033	54
Set of 3 p-Orbitals	U40012	250	Slotted Weights, 5 x 50 g, Set of	U30032	54
Set of 3 Prisms	U14050	166	Slotted Weights, 8 x 50 g, Red and Grey, Set of	U8404775	54
Set of 3 Safety Experiment Leads for Free Fall Apparatus	U13811	300	Sodium Fluorescence Tube on Furnace Wall	U8482260	258
Set of 3 Steel Balls	U8400735	67	Soft Iron Bars	U19556	215
Set of 3 Thermocouples	U8557370	295	Software for Fourier Analysis	U8511700	47
Set of 3 Weight Holders with Slotted Weights	U30019	55	Solar Energy	–	30, 120
Set of 30 Electrodes for ECG/EMG	U11398	44	Solar Energy Basic Kit	U8461200	120
Set of 4 Calorimeter Cylinders	U30070	129	Solid-State Laser Physics	–	184 – 187
Set of 4 Gratings	U19515	163	s-Orbital	U40010	250
Set of 4 Image Objects	U8476605	161	Sound	–	103 – 110
Set of 4 Pendulum Bobs	U30035	75	Sound Level Meter P5055	U11801	283
Set of 5 Carbon Plates	U11106	213	Spare Bulb for Stroboscope	U40161	285
Set of 5 Density Bodies	U8404556	83	Spare Bulbs for Halogen Lamp (230 V, 50/60 Hz)	U8476714-230	120
Set of 5 d-Orbitals	U40014	250	Spare Halogen Lamp, 12 V, 50 W	U13735	155
Set of 5 Hole Diaphragms	U8470800	161	Spare Lamp for Light Box	U30039	35
Set of 5 Metal Strips	U8497330	229	Spare Sodium Lamp	U33403	175
Set of 5 Nickel Plates	U11104	213	Spare Tube for Pneumatic Lighter	U8741185	140
Set of 5 Single Slits	U8470790	162	Spare Tube for X-Ray Apparatus	U19204	258a
Set of 5 Slit and Hole Diaphragms	U17040	161	Special Carbon Paper, Set	U405161	65
Set of 6 Safety Crocodile Clips 4 mm	U13820	300	Spectral Lamp Cd	U8476800	176
Set of 6 Steel Balls	U15014	68	Spectral Lamp He	U8476810	176
Set of 60 Ecoflam Pellets	W13654	291	Spectral Lamp Hg 100	U8476870	176
Set of 7 Colour Filters	U19530	165	Spectral Lamp Hg/Cd	U8476875	176
Set of 7 Cubes for Determining Density	U8404509	85	Spectral Lamp Na	U8476840	176
Set of 7 f-Orbitals	U40016	250	Spectral Lamp Ne	U8476850	176
Set of Apparatus for Displaying Magnetic Fields	U8491790	219	Spectral Lamp Tl	U8476855	176
Set of Bodies for Air Resistance and Buoyancy Experiments	U8404260	94	Spectrometer-Goniometer	U14416	179
Set of Components for Electronics Experiments	U8557280	209	Spectrometer-Goniometer S	U22050	179
Set of Doppler Prisms and Flow Tubes	U10002	118	Spectrometers	–	178 – 181
Set of Drawing Instruments for Whiteboard	U10045	295	Spectrometry Supplementary Set	U22056	188
Set of Experiment Leads for Electron Tube Experiments	U138101	299	Spectrophotometer S	U17310	181
Set of Fluorescence Samples	U40206	258h	Spectroscope in Cardboard Case	U21876	178
Set of Four Conductors for Biot-Savart Experiments	U8557240	221	Spectroscope in Metal Case	U21877	178
Set of Fuses	U11269	300	Spectrum Tube Air	U41810	176
Set of Helical Springs for Hooke's Law	U40816	53	Spectrum Tube Argon	U41811	176
Set of Hook Weights and Thread	U8557450	63, 295	Spectrum Tube Bromine	U41812	176
Set of Optical Components	U15530	149	Spectrum Tube Carbon Dioxide	U41813	176
Set of Plotter Paper	U405121	65	Spectrum Tube Chlorine	U41814	176
Set of Riders for Rulers	U8401570	50	Spectrum Tube Deuterium	U41815	176
Set of Seals	U10402	139	Spectrum Tube Helium	U41816	176
Set of Slotted Weights, 10 x 10 g	U30031	54	Spectrum Tube Hydrogen	U41817	176
Set of Slotted Weights, 10 x 10 g, Red and Grey	U8404760	54	Spectrum Tube Iodine	U41818	176
Set of Slotted Weights, 20 – 100 g	U30030	54	Spectrum Tube Krypton	U41819	176
Set of Slotted Weights, 4 x 100 g, Red and Grey	U8404785	54	Spectrum Tube Mercury	U41820	176
Set of Slotted Weights, 5 x 100 g	U30033	54	Spectrum Tube Neon	U41821	176
Set of Slotted Weights, 5 x 50 g	U30032	54	Spectrum Tube Nitrogen	U41822	176
Set of Slotted Weights, 8 x 50 g, Red and Grey	U8404775	54	Spectrum Tube Oxygen	U41823	176
Set of Special Carbon Paper	U405161	65	Spectrum Tube Power Supply (115V, 50/60 Hz)	U418001-115	176
Set of Test Bodies for Torsion Axle	U20051	82	Spectrum Tube Power Supply (230V, 50/60 Hz)	U418001-230	176
Set of Tuning Forks for the C-Major Scale	U10100	109	Spectrum Tube Water Vapor	U41824	176
Set of Tuning Forks, C-Major Chord, on Resonance Boxes	U10125	109	Spectrum Tube Xenon	U41825	176
Set of Weights 1 g to 1000 g	U30014	54	Spectrum Tubes and Spectrum Lamps	–	176 – 177
Set of Weights 1 g to 50 g	U30012	54	Speed of Light	–	190
Set of Weights 1 g to 500 g	U29576	55	Speed of Light Meter (115 V, 50/60 Hz)	U8476460-230	190
Set of Weights 1 g to 500 g, slotted with Holder	U300131	54	Speed of Light Meter (230 V, 50/60 Hz)	U8476460-115	190
Set of Weights 1 mg to 500 mg	U29952	55	Sphere for Weighing Gases 1000 ml	U8422050	85
Set of Weights 10 g to 1000 g	U30016	54	Spinthariscopes	U8482490	260
Set of Weights 100 g to 2000 g	U8671420	54	Spirit Lamp	U8621240	291
Set of Weights with Hooks	U29543	55	Stability Apparatus	U15033	57
Shadow Casting Bodies	U15525	146	Stable Tube-Type Thermometer -1 – 101°C	U16115	124 – 125
Shaker	U11452	218	Stainless Steel Rod 100 mm	U15000	298
Shear Modulus	–	89	Stainless Steel Rod 1000 mm	U15004	298
Silicon Diode, 1N 4007, P2W19	U333072	207	Stainless Steel Rod 1500 mm	U15005	298
			Stainless Steel Rod 250 mm	U15001	298
			Stainless Steel Rod 470 mm	U15002	298
			Stainless Steel Rod 750 mm	U15003	298
			Stainless Steel Rod, 280 mm, 10 mm diam.	U8611461	298
			Stainless Steel Rod, 400 mm, 10 mm diam.	U8611460	298
			Stand Base, A-Shaped 200 mm	U8611160	296
			Stand Base, A-Shaped 280 mm	U8611150	296

Description	Art. No.	Page
Stand for Cylindrical Coils	U8496150	220
Stand with H-Shaped Base	U8557440	296
Stands, Clamps and Accessories	–	296 – 298
Statics	–	57
Steam Engine B	U13850	145
Steam Engine G	U10055	145
Steam Generator (115 V, 50/60 Hz)	U8624650-115	131
Steam Generator(230 V, 50/60 Hz)	U8624650-230	131
Steel Balls, Set of 3	U8400735	67
Steel Balls, Set of 6	U15014	68
Steel Safe for Radioactive Materials	U8483219	261
Stefan Boltzmann Lamp	U8490050	135
Stirling Engine D	U8440450	142
Stirling Engine G	U10050	141
Stirling Engine S	U49327	143
Storage Box	U8776140	150 – 151
Storing Base for Lenses	U17120	159
Straight Conductor on Acrylic Base	U8491791	219
Striking Hammer, Hard	U10118	109
Striking Hammer, Soft	U10122	109
Stroboscope, Digital (115 V, 50/60 Hz)	U40160-115	285
Stroboscope, Digital (230 V, 50/60 Hz)	U40160-230	285
Student Experiment Kits (SEK)	–	16 – 31
Student Experiments	–	8 – 37
STUDENT Kit – Basic Set	U60011	8
STUDENT Kit – Electricity	U60070	12 – 14
STUDENT Kit – Electrostatics	U60060	14
STUDENT Kit – Heat	U60040	10
STUDENT Kit – Mechanics	U60020	9
STUDENT Kit – Optics (115 V, 50/60 Hz)	U60050-115	11
STUDENT Kit – Optics (230 V, 50/60 Hz)	U60050-230	11
Supplemental Set "Optics with Laser Ray Box"	U17301	148
Supplementary Kit for Rotating System on Air Bed	U8405690	72
Supplementary Set for Interference	U8477130	32 – 33
Supplementary Set for Polarisation	U8477140	32 – 33
Supplementary Set for Stirling Engine D	U8440455	142
Supplementary Set for Torsion Apparatus	U8557430	89
Support for Optical Bench D	U103041	155
Surface Tension	–	87
Surface Tension Ring	U8412160	87
Suspended Magnet	U8495222	214
SW Physical Pendulum Set	U61024	78 – 79
SW Sensors Set (115 V, 50/60 Hz)	U61023-115	78 – 79
SW Sensors Set (230 V, 50/60 Hz)	U61023-230	78 – 79
SW Stand Equipment Set	U61022	298
SW String Pendulum Set	U61025	78 – 79
SW Wilberforce Pendulum Set	U61021	78 – 79
Switch Box	U20612	62 – 63
Switch on 3B-Box	U29511	200 – 201
Switch, Single, P4W50	U333101	208
Swivel Joint for Optical Bench D	U10305	155
Swivel Joint with Scale	U17165	153
– T –		
Table Clamp	U13260	297
Table Top Stop Clock	U11900	49
Table-Top Power Supply	U8498305	136, 267
Tandem Pulley, 2 Pulleys	U30026	60
Tandem Pulley, 3 Pulleys	U30027	60
Ta ₂ Sample	U13913	247
TaSe ₂ Sample	U13912	247
TELTRON®	–	232 – 242
Temperature Sensor	U10368	128
Temperature Sensor, Pt100	U11330	42, 124 – 125
Temperature Sensor, Pt100 with Measurement Terminal	U11329	42, 144
Temperature Sensor, TC – K	U11331	42, 124 – 125
Tension Ring DN 10/16 KF	U14517	93
Tesla Transformer	U8496250	231
Teslameter 200 mT (115 V, 50/60 Hz)	U33110-115	286
Teslameter 200 mT (230 V, 50/60 Hz)	U33110-230	286
Teslameter E	U8533982	286
Test Bodies for Torsion Axle, Set	U20051	82
Test Vessel, Complete	U10008	112
Thermal Conductivity Equipment Kit	U45055	133
Thermal Expansion	–	130 – 132
Thermocouples, Set of 3	U8557370	295
Thermometers	–	124 – 127
Thermometer +10 – 30°C	U8451700	124 – 125
Thermometer -10 – 150°C	U40913	124 – 125
Thermometer -10°C – 200°C	U8451204	124 – 125
Thermometer -20 – 110°C	U40911	124 – 125
Thermometer -20 – 110°C / 0 – 230°F	U40915	124 – 125
Thermometer -20 – 150°C / 0 – 300°F	U40916	124 – 125
Thermometer clip	U8452570	124 – 125
Thomson Tube S	U18555	237
Thyristor, TYN 1012, P4W50	U333087	208
Tilting Rider D	U103301	154
Timer	U16100	49
Toggle Switch on Acrylic Base	U8495910	198
Torsion Apparatus	U8557300	89
Torsion Axle	U20050	82

Description	Art. No.	Page
Total Reflection Apparatus on Stem	U8474030	158
T-Piece DN 16 KF	U14512	93
T-Piece, BNC	U11261	301
Tracing Compasses, Set of 10	U19562	217
Training Oscilloscope	U8481350	243
Transformers	–	228 – 231
Transformer 12 V, 25 VA (115 V, 50/60 Hz)	U8475470-115	266
Transformer 12 V, 25 VA (230 V, 50/60 Hz)	U8475470-230	266
Transformer 12 V, 60 VA (115 V, 50/60 Hz)	U13900-115	266
Transformer 12 V, 60 VA (230 V, 50/60 Hz)	U13900-230	266
Transformer Core D	U8497180	228
Transformer Core S	U8498112	230
Transformer with Rectifier		
2/ 4/ 6/ 8/ 10/ 12/ 14 V, 5 A (115 V, 50/60 Hz)	U8521112-115	267
Transformer with Rectifier		
2/ 4/ 6/ 8/ 10/ 12/ 14 V, 5 A (230 V, 50/60 Hz)	U8521112-230	267
Transformer with Rectifier 3/ 6/ 9/ 12 V, 3 A (115 V, 50/60 Hz)	U33300-115	267
Transformer with Rectifier 3/ 6/ 9/ 12 V, 3 A (230 V, 50/60 Hz)	U33300-230	267
Transformer, Demountable	–	228 – 230
Transistor FET , BF 244, P4W50	U333086	208
Transistor NPN , BC 550, P4W50	U333084	208
Transistor NPN , BD 137, P4W50	U333082	208
Transistor NPN BC140, P4W50	U333112	208
Transistor PNP BC160, P4W50	U333113	208
Transistor PNP, BC 560, P4W50	U333085	208
Transistor PNP, BD 138, P4W50	U333083	208
Transmission Grating 300 Lines/mm	U19512	162
Transmission Grating 600 Lines/mm	U19511	162
Transparent Acrylic Plate	U8476371	197
Transport Case KL	U14049	184 – 187
Triac, BT 137/800, P4W50	U333088	208
Trigger Device for Maxwell's Wheel	U8404050	70
Triode D	U19151	234
Triode S	U18551	239
Triple/Quintuple Slit N	U8478110	152
Tripod Stand 150 mm	U13270	296
Tripod Stand 185 mm	U13271	296
Trolley Track, 1.8m	U35001	61
Tube Holder D	U191001	236
Tube Holder S	U185002	241
Tube Thermometer, Graduated -10 – 110°C	U14295	124 – 125
Tube Thermometer, not Graduated	U14296	124 – 125
Tube with 6 Induction Coils	U8511200	225
Tubing	–	298
Tubing, Silicone 6 mm	U10146	298
Tungsten Wire	U40210	56
Tuning Fork 21 Hz with Plotter Pen	U8431030	108
Tuning Fork, 2000 Hz	U10117	108
Tuning Fork, 440 Hz, on Resonance Box	U10121	108
Tuning Forks for the C-Major Scale, Set of	U10100	109
Tuning Forks, 440 Hz, on Resonance Boxes, Pair of	U10120	109
Tuning Forks, C-Major Chord, on Resonance Boxes, Set of	U10125	109
Tuning Weights, Pair	U10119	109
Turn Table	U45001	74
Two Way Ball Valve DN 16 KF	U14510	93
Two-Channel Function Generator, 20 MHz	U22065	274
Two-pole Switch	U8495901	295
Tyndall's Bar Breaker	U8442150	130
Type K/IR Thermometer	U11823	127
– U –		
U Core D	U8497215	230
Ultrasonic Adaptor Lead	U8557390	301
Ultrasonic Coupling Gel	XP999	116
Ultrasonic cw Generator with Probe	U100061	112
Ultrasonic Doppler Apparatus	U10001	117
Ultrasonic Echoscope GS200	U100102	113
Ultrasonic Motion Sensor	U11361	41
Ultrasonic Probe 1MHz GS200	U100151	114
Ultrasonic Probe 2MHz GS200	U100161	114
Ultrasonic Probe 4MHz GS200	U100171	114
Ultrasonic Probe, 2 MHz	U10016	118
Ultrasound	–	111 – 119
Ultrasound in Solids, Equipment Set	U10020	114
Ultrasound Transducer 40 kHz		
Equipment Kit	U8552003	111
Undoped Germanium on Printed Circuit Board	U8487010	264 – 265
Uniform Acceleration	–	68
Universal Areometer	U14291	84
Universal Clamp	U13255	297
Universal Holder on 3B Box	U29528	200 – 201
Universal Jaw Clamp	U13261	297
Universal Spirit Level, 250 mm	U10074	57
Unknown Resistors in 3B Box	U29807	200 – 201
USB Interface	U42056	289
USB Oscilloscope 2 x 50 MHz	U112491	276 – 277
U-Tube Manometer D	U30082	86

Description	Art. No.	Page	Description	Art. No.	Page
U-Tube Manometer S	U8410450	86	Wave Optics with Laser, Equipment Set for	U17303	169
UV A/B Sensor	U11369	42	Waveguide Optics, Equipment set	U17304	189
- V -			Waves and Particles	-	232, 240
Vacuum		90 - 91	Waves and Sound	-	96 - 119
Vacuum Bell Jar	U21851	91	Weather	-	122
Vacuum Chamber with Hand Pump	U29497	90	Weather Station, Wireless	W13620	123
Vacuum Experiment Plate	U21850	91	Wedge-Shaped Vessel	U8411130	87
Vacuum Hand Pump	U205001	92	Weight Holders with Slotted weights, Set of 3	U30019	55
Vacuum Hose, 10 mm	U10141	92, 298	Weights 1 g to 1000 g, Set of	U30014	54
Vacuum Hose, 4 mm	U10148	92, 298	Weights 1 g to 50 g, Set of	U30012	54
Vacuum Hose, 6 mm	U10147	92, 298	Weights 1 g to 500 g, Set of	U29576	55
Vacuum Hose, 8 mm	U10140	92, 298	Weights 1 g to 500 g, slotted with Holder, Set of	U300131	54
Vacuum Photocell	U8482415	253	Weights 1 mg to 500 mg, Set of	U29952	55
Vacuum Pumps	-	92 - 93	Weights 10 g to 1000 g, Set of	U30016	54
Vacuum Recipient	U8421300	91	Weights 100 g to 2000 g, Set of	U8671420	54
Vacuum Student Kit	U45052	34	Weights with Hooks, Set of	U29543	55
Van de Graaff Generator (115 V, 50/60 Hz)	U15300-115	192	Weights, 10 g, Set of 10	U8404710	54
Van de Graaff Generator (230 V, 50/60 Hz)	U15300-230	192	Weights, 20 g, Set of 10	U8404700	54
Vane Wheel	U20020	133	Weights, 50 g, Set of 10	U8404720	54
Variable g Pendulum	U8403950	76	Whiteboard 600x900 mm ²	U10030	147, 295
Variable Inductance Coil	U21903	226	Whiteboard 900x1200 mm ²	U10031	147, 295
Variable Leak Valve, DN 16 KF	U13115	93	Whiteboards	-	295
Variable-Focus Lens	U17109	157	Wick	U8621250	291
VDR Resistor, P2W19	U333109	207	Wide-Band Loudspeaker	U8432770	111
Velocity of Sound in Solid Objects	-	107	Wimshurst Machine	U15310	192
Velocity of Sound in Air	-	103	Wireless Weather Station	W13620	123
Ventilation Valve DN 16 KF	U14513	93	Wooden Blocks for Friction Experiments	U15026	58
Vernier Model	U15035	51	Wooden Rulers, 0.5 m, Set of 10	U30042	51
Vertical and Horizontal Trajectories	-	68 - 70	Wooden Rulers, 1 m, Set of 10	U30041	51
Vertical Ruler, 1 m	U8401560	50	WSe ₂ Sample	U13911	247
Vessel with Overflow, Metal	U30080	51	- X -		
Vessel with Overflow, Transparent	U8411310	51	X-Ray Apparatus (115 V, 50/60 Hz)	U192001-US	258a
Vibration Generator	U56001	100	X-Ray Apparatus (230 V, 50/60 Hz)	U192001	258a
Video Cameras	-	292 - 293	X-Ray Energy Detector	U10600	258f - g
Viscosity	-	88	X-Rays	-	258a-h
Vision Viewer	U42103	292 - 293	- Y -		
Volta's Pile on 3B Box	U29504	200 - 201	Yi Bell	U30002	303
Voltage Regulating Transformer (230 V, 50/60 Hz)	U117401-230	267	Young's Modulus Supplementary Set	U8557270	89
Voltmeter, AC	U11813	278	Young's Modulus	-	89
Voltmeter, DC	U11811	278	- Z -		
Volumetric Dilatometer	U14225	132	Zener Diode, ZPD 18, P2W19	U333078	207
- W -			Zener Diode, ZPD 3.3, P2W19	U333073	207
Waltenhofen's Pendulum	U8497500	226	Zener Diode, ZPD 6.2, P2W19	U333075	207
Warning Notice: "Radioactive"	U8483218	261	Zener Diode, ZPD 9.1, P2W19	U333074	207
Watch Glass Dishes, 120 mm, Set of 10	U14201	302	Zener Diode, ZPY 5.6, P2W19	U333076	207
Watch Glass Dishes, 80 mm, Set of 10	U14200	302	Zener Diode, ZPY 8.2, P2W19	U333077	207
Water Wave Channel	U8431411	99	Zero Point Galvanometer CA 403	U11170	279
Water Waves	-	98	Zinc Plates, Set of 10	U11102	213
Water-Jet Pump	U16050	92	Zinc Sample for Hall Effect	U8557410	265
Watt's Governor	U8403115	73			
Wave Machine, Manual	U8431805	102			
Wave Optics	-	96 - 97			

Art. No.	Page	Art. No.	Page	Art. No.	Page	Art. No.	Page	Art. No.	Page
F15	191	U10029	115	U10141	92, 298	U10353	182	U10700-115	252
L55/1	116	U10030	147, 295	U10146	298	U10354	182	U10700-230	252
T52006	132, 302	U10031	147, 295	U10147	92, 298	U10355	86	U10710	140
U10001	117	U10045	295	U10148	92, 298	U10360	68	U10800-115	210
U10002	118	U10050	141	U101601	181	U10361	68	U10800-230	210
U10003	118	U10055	145	U102301	289	U10362	69	U109501	120
U10004	116	U10060	143	U10260	122	U10363	69	U109552	36
U10005	117	U10061	143	U10300	154	U10365	128	U11010	52
U100061	112	U10070	50	U10301	154	U10366	128	U11011	52
U10007	112	U10071	50	U10302	154	U10367	128	U11012	52
U10008	112	U10072	50	U103041	155	U10368	128	U11013	52
U10009	112	U10073	50	U10305	155	U10369	128	U11025	53
U100102	113	U10074	57	U103101	154	U10370	222 - 223	U11026	53
U100151	114	U10100	109	U103111	154	U10371	222 - 223	U11027	53
U10016	118	U10110	108	U103121	154	U10372	222 - 223	U11040	170
U100161	114	U10115	108	U103151	154	U10375	227	U11051	194
U100171	114	U10116	108	U103161	154	U104001	138	U11052	194
U10018	116	U10117	108	U103171	154	U10401	139	U11053	194
U10019	118	U10118	109	U10319	155	U10402	139	U11055	298
U10020	114	U10119	109	U103202	154	U10530	184	U11060	171
U10022	114	U10120	109	U103301	154	U10610	123	U11065	213
U10023	114	U10121	108	U10331	155	U10630	119	U11066	213
U100251	114	U10122	109	U10345	160	U10631	119	U11100	213
U10026	115	U10125	109	U10350	183	U10632	119	U11101	213
U10027	115	U10140	92, 298	U10351	183	U10633	119	U11102	213

Art. No.	Page	Art. No.	Page	Art. No.	Page	Art. No.	Page	Art. No.	Page
U11103	213	U11803	283	U14040	184 – 187	U15300-115	192	U18557	239
U11104	213	U11804	283	U14044	184 – 187	U15300-230	192	U18558	239
U11105	213	U11806	280	U14046	184 – 187	U15301	192	U18560	256 – 257
U11106	213	U11807.1	280	U14047.1	184 – 187	U15310	192	U18565	256 – 257
U11110	211	U11808.2	281	U14049	184 – 187	U15321	199	U18570	240
U11111	211	U11809.1	280	U14050	166	U15350	218	U18571.1	240
U11112	175	U11810	278	U14051	166	U15351	218	U18575	245
U11151.1	29, 259	U11811	278	U14052	166	U15400	131	U18580	242
U11165	276 – 277	U11812	278	U14053	167	U15405	131	U186501-115	256 – 257
U11166	276 – 277	U11813	278	U14085	184	U15420	137	U186501-230	256 – 257
U11167	276 – 277	U11814	278	U14090	83	U15425-115	63, 94	U188031-115	262 – 263
U11170	279	U11815.2	127	U14100	163	U15425-230	63, 94	U188031-230	262 – 263
U11175	275	U11816.1	127	U14101	163	U15500	170	U188501	262 – 263
U11180	203	U11817	127	U14102	163	U15510	146	U189021	262 – 263
U11181	203	U11818	127	U14103	163	U15511	146	U191001	236
U11182	203	U11819	122	U14104	163	U15515	146	U191051	236
U11183	203	U11820.1	204	U14106	163	U15516	146	U19106	236
U11184	203	U11821.1	204	U14107	162	U15517	146	U191501	234
U11185	203	U11823	127	U14108	163	U15518	146	U19151	234
U11190	203	U11824.1	281	U14200	302	U15520	146	U19152	233
U11191	203	U11826.1-230	283	U14201	302	U15525	146	U19153	233
U11230-230	274	U11827-115	270	U14205	301, 302	U15530	149	U19154	233
U11234-230	275	U11827-230	270	U14206	302	U16050	92	U19155	232
U11249.1	276 – 277	U11853	124 – 125	U14210	302	U16100	49	U19157	234
U11255	301	U11854	124 – 125	U14211	302	U16101	126	U19170	235
U11257	301	U11855	124 – 125	U14220	84	U16102	122	U19171.1	232
U11258	301	U11875-115	290	U14224	195, 302	U16106	84	U19172	236
U11259	301	U11875-230	290	U14225	132	U16115	124 – 125	U19500	178
U11260	301	U11876	290	U14260	88	U16120	124 – 125	U19511	162
U11261	301	U11900	49	U14290	84	U17001	158	U19512	162
U11269	300	U11901	49	U14291	84	U17010	159	U19515	163
U11275	282	U11902	49	U14293	122	U17020	159	U19520	162
U11276	282	U11922	166	U14295	124 – 125	U17040	161	U19525	162
U11277	282	U11983.1	70	U14296	124 – 125	U17101	157	U19530	165
U11300-115	39	U12250.1	226	U14297	124 – 125	U17102	157	U19550	214
U11300-230	39	U12252	220	U14300	135	U17103	157	U19551	214
U11300ip-115	39	U12253	220	U14313	175	U17104	157	U19553	214
U11300ip-230	39	U13109	251	U14314	175	U17105	157	U19555	214
U11305-115	46	U13115	93	U14318	132	U17106	157	U19556	215
U11305-230	46	U13250	297	U14321	87	U17107	157	U19557	215
U11310	38	U13252	297	U14325	86	U17108	157	U19560	218
U11315	43	U13253	297	U14327	140	U17109	157	U19561	217
U11320	43	U13255	297	U14328	140	U17110	157	U19562	217
U11321	43	U13256	297	U14330	213	U17111	157	U19563	215
U11323	43	U13257	297	U14331	212	U17112	157	U19600	56
U11325	43	U13260	297	U14332	212	U17120	159	U19700.1	246
U11329	42, 144	U13261	297	U14340	133	U17128	153	U19705.1	246
U11330	42, 124 – 125	U13265	296	U14350	303	U17130	159	U20020	133
U11331	42, 124 – 125	U13270	296	U14380	242	U17140	155	U20030	52
U11334	45	U13271	296	U14390	174	U17150	153	U20031	52
U11335	45	U13735	155	U14400.2-115	139	U17151	153	U20032	53, 58
U11336	43	U13760	299	U14400.2-230	139	U17160	153	U20033	53, 58
U11337	46	U13761	299	U14415	179	U17161	153	U20034	52
U11350	45	U13800	299	U14416	179	U17165	153	U20035	53, 58
U11351	45	U13801	299	U14424	162	U17166.1	153	U20036	52
U11352	45	U13802.1	300	U14501	93	U17205	55	U20037	53
U11354	41	U13810.1	299	U14505.1	93	U17206	83	U20038	52
U11359	42	U13811	300	U14510	93	U17207	83	U20050	82
U11360	42	U13812	300	U14511	93	U17209	222	U20051	82
U11361	41	U13813	299	U14512	93	U17210.1	140	U20500.1	92
U11362	41	U13814	300	U14513	93	U17250	193	U20550	214
U11363	41	U13816	300	U14514	93	U17300	148	U20570	214
U11364	44	U13817	300	U14515	93	U17301	148	U20610	62 – 63
U11365	40, 49	U13818	300	U14516	93	U17302-115	148	U20611	62 – 63
U11366	40	U13820	300	U14517	93	U17302-230	148	U20612	62 – 63
U11367	41	U13821	299	U14518	93	U17303	169	U20700-115	251
U11368	46	U13850	145	U14600	146	U17304	189	U20700-230	251
U11369	42	U13851	145	U15000	298	U17305	189	U210051-115	285
U11371	41	U13852	145	U15001	298	U17306	148	U210051-230	285
U11372	141	U13900-115	266	U15002	298	U17307-115	149	U21603.1	217
U11375	43	U13900-230	266	U15003	298	U17307-230	149	U21827-230	177
U11376	46	U13910	247	U15004	298	U17308	160	U21828-230	177
U11377	46	U13911	247	U15005	298	U17309	160	U21829-230	177
U11380-115	205	U13912	247	U15014	68	U17310	181	U21831-230	177
U11380-230	205	U13913	247	U15015	57	U17350	203	U21832-230	177
U11392	44	U13914	247	U15020	296	U17351	203	U21833-230	177
U11393	44	U13915	247	U15021	296	U17352	203	U21835	159
U11396	44	U14000.1	166	U15022	296	U17353	203	U21840	156
U11398	44	U14005	166	U15026	58	U17354	203	U21850	91
U11451	218	U14010	166	U15027	53	U17355	203	U21851	91
U11452	218	U14015	166	U15028	53	U17356	203	U21853	91
U11705-115	270	U14020	167	U15030	50	U17357	203	U21854	91
U11705-230	270	U14021	184 – 187	U15033	57	U17450	278	U21870	162
U11710-115	270	U14022	184 – 187	U15035	51	U17451	278	U21871	163
U11710-230	270	U14024	184 – 187	U15036	84	U18500.1	241	U21872	163
U117301-230	268	U14025	184 – 187	U15037	84	U18505.1	241	U21873	163
U11736.1	270	U14026	184 – 187	U15038	84	U18550.1	239	U21874	163
U117401-230	267	U14027	184 – 187	U15039	84	U18551	239	U21876	178
U117601-115	268	U14028	184 – 187	U15040	81	U18552	238	U21877	178
U117601-230	268	U14029	184 – 187	U15070	86	U18553	238	U21878	165
U11800	274	U14038	184 – 187	U15100	110	U18554	238	U21879	165
U11801	283	U14039	184 – 187	U15101	110	U18555	237	U21880	149

Art. No.	Page	Art. No.	Page	Art. No.	Page	Art. No.	Page	Art. No.	Page
U21881	155	U30001	303	U333043	208	U40170	126	U52010	74
U21883	171	U30002	303	U333044	208	U40173	126	U52011	57
U21885	302	U30010	90	U333045	208	U40205	56	U55001	108
U21887	149	U30011	35	U333046	208	U40210	56	U56001	100
U21900	217	U30012	54	U333047	208	U40275	190	U56002	100
U21901	220	U300131	54	U333048	207	U40276	190	U56003	100
U21903	226	U30014	54	U333049	207	U405001-115	64	U56004	139
U21905-115	176	U30015	60	U333050	207	U405002-230	64	U56005	101
U21905-230	176	U30016	54	U333051	206	U40510	65	U56006	101
U21906	176	U30019	55	U333052	206	U405121	65	U56007	100
U219101	98	U30020	60	U333053	206	U40513	65	U58010	212
U22000	156	U30021	60	U333054	206	U40514	65	U58011	212
U22001	156	U30022	60	U333055	206	U40515	65	U58020	87
U22002	156	U30025	60	U333056	206	U405161	65	U58021	87
U22010	158	U30026	60	U333057	206	U40550	70	U58030	132
U22011	164	U30027	60	U333058	206	U40800	49	U58031	133
U22012	164	U30028	59	U333059	206	U40801	49	U60011	8
U22014	164	U30030	54	U333060	206	U40810	52	U60020	9
U22015	164	U30031	54	U333061	206	U40811	52	U60040	10
U22017	158	U30032	54	U333062	206	U40812	52	U60050-115	11
U22018	160	U30033	54	U333063	206	U40813	52	U60050-230	11
U22019	165	U30034	99	U333064	206	U40814	52	U60060	14
U22020	165	U30035	75	U333065	206	U40815	52	U60070	12 – 14
U22021	165	U30039	35	U333066	206	U40816	53	U61010-115	26
U22025	164	U30040	197	U333067	206	U40875	83	U61010-230	26
U22026	164	U30041	51	U333068	206	U409001	130	U61020-115	24
U22027	161	U30042	51	U333069	207	U409051	133	U61020-230	24
U22028	180 – 181	U30045	77	U333070	207	U40911	124 – 125	U61021	78 – 79
U22029	180 – 181	U30048	220	U333071	207	U40913	124 – 125	U61022	298
U22031	180 – 181	U30065	222	U333072	207	U40915	124 – 125	U61023-115	78 – 79
U22050	179	U30066	225	U333073	207	U40916	124 – 125	U61023-230	78 – 79
U22055	188	U30070	129	U333074	207	U418001-115	176	U61024	78 – 79
U22056	188	U30071	129	U333075	207	U418001-230	176	U61025	78 – 79
U22058	172 – 173	U30072	129	U333076	207	U41810	176	U8400040	48
U22060	276 – 277	U30073	129	U333077	207	U41811	176	U8400735	67
U22065	274	U30074	129	U333078	207	U41812	176	U8400830	67
U287020	161	U30075	129	U333079	207	U41813	176	U8400870	66
U287050	161	U30080	51	U333080	207	U41814	176	U8400930	69
U29025	290	U30082	86	U333081	207	U41815	176	U8401010	53
U29310	215	U30084	87	U333082	208	U41816	176	U8401550	50
U29427	302	U30086	227	U333083	208	U41817	176	U8401560	50
U29428	302	U30723	294	U333084	208	U41818	176	U8401570	50
U29453	302	U33000-115	271	U333085	208	U41819	176	U8402501	52
U29491	51	U33000-230	271	U333086	208	U41820	176	U8402502	52
U29496	90	U33010-115	271	U333087	208	U41821	176	U8402505	52
U29497	90	U33010-230	271	U333088	208	U41822	176	U8402510	52
U29504	200 – 201	U33020-115	270	U333089	208	U41823	176	U8403000-115	80
U29509	199	U33020-230	270	U333090	208	U41824	176	U8403000-230	80
U29510	200 – 201	U33030-115	269	U333091	207	U41825	176	U8403115	73
U29511	200 – 201	U33030-230	269	U333092	207	U42000	288	U8403315	84
U29512	199	U33035-115	231, 269	U333093	209	U42007	288	U8403325	84
U29513	199	U33035-230	231, 269	U333094	209	U42010	288	U8403950	76
U29514	199	U33070-230	275	U333095	209	U42047	55	U8403955	76
U29515	199	U33110-115	286	U333096	207	U42048-230	289	U8404050	70
U29516	199	U33110-230	286	U333097	207	U42049-230	289	U8404248	95
U29517	199	U33200-115	81, 266	U333098	207	U42050-230	289	U8404250	94
U29518	200 – 201	U33200-230	81, 266	U333099	208	U42056	289	U8404260	94
U29524	200 – 201	U33250	206	U333100	208	U42060	288	U8404261	94
U29526	200 – 201	U33300-115	267	U333101	208	U42061	288	U8404275-115	75
U29527	200 – 201	U33300-230	267	U333102	209	U42102	292 – 293	U8404275-230	75
U29528	200 – 201	U333011	206	U333103	207	U42103	292 – 293	U8404280	75
U29529	200 – 201	U333012	206	U333106	206	U42104	292 – 293	U8404300	95
U29530	200 – 201	U333013	206	U333107	207	U450001	74	U8404509	85
U29538	227	U333014	206	U333108	207	U45001	74	U8404550	51
U29543	55	U333015	206	U333109	207	U45011	102	U8404556	83
U29555	170	U333016	206	U333110	207	U45012	102	U8404700	54
U29563	122	U333017	206	U333111	207	U45052	34	U8404710	54
U29564	301	U333018	206	U333112	208	U45053	86	U8404720	54
U29576	55	U333019	206	U333113	208	U45054	90	U8404760	54
U29577	200 – 201	U333020	206	U333114	209	U45055	133	U8404775	54
U29578	200 – 201	U333021	206	U33400	175	U45056	84	U8404785	54
U29579	200 – 201	U333022	206	U33401	175	U45057	85	U8405120	58
U29587	170	U333023	206	U33402	175	U45058	85	U8405630	66
U29589	199	U333024	206	U33403	175	U45059	85	U8405640	66
U29590	199	U333025	206	U34000	92	U45060	34	U8405680-115	72
U29591	199	U333026	206	U34010	92	U45060-4	34	U8405680-230	72
U29592	199	U333027	206	U35001	61	U46000	261	U8405690	72
U29593	199	U333028	206	U40010	250	U46010	261	U8405715	73
U29595	200 – 201	U333029	206	U40012	250	U49327	143	U8405820	53
U29622	51	U333030	206	U40014	250	U51001	195	U8405830	99
U29625	50	U333031	206	U40016	250	U51004	202	U8405840	53
U29627	126	U333032	206	U40020	248 – 249	U51005	202	U8408035	17
U29802	200 – 201	U333033	206	U40030	248 – 249	U51006	202	U8408305	70
U29803	200 – 201	U333034	206	U40110	146	U51007	202	U8409250	58
U29804	200 – 201	U333035	206	U40113	146	U51008	202	U8409270	57
U29805	200 – 201	U333036	206	U40120	147	U51009	202	U8410355	83
U29806	200 – 201	U333037	206	U40121	147	U51010	202	U8410450	86
U29807	200 – 201	U333038	206	U40122	147	U51011	202	U8410620	87, 301
U29812	51	U333039	206	U40129	162	U51012	202	U8411130	87
U29948	123	U333040	206	U40160-115	285	U51013	202	U8411310	51
U29952	55	U333041	206	U40160-230	285	U52004	57	U8412150	85
U300001	303	U333042	208	U40161	285	U52006	74	U8412160	87

Art. No.	Page	Art. No.	Page	Art. No.	Page	Art. No.	Page	Art. No.	Page
U8421210	92	U8476460-115	190	U8495490	198	U8521131-115	268	U8624650-230	131
U8421300	91	U8476460-230	190	U8495505	198	U8521131-230	268	U8671420	54
U8422050	85	U8476515	150 – 151	U8495515	198	U8521371-115	271	U8713100	199
U8422090	67	U8476526	150 – 151	U8495527	198	U8521371-230	271	U8724980	295
U8430160	110	U8476600	162	U8495532	198	U8521380	266	U8741180	140
U8430185	110	U8476605	161	U8495537	198	U8521385	266	U8741185	140
U8430290	110	U8476630	150 – 151	U8495540	198	U8521400-115	269	U8761161-115	174
U8430310	110	U8476655	163	U8495550	198	U8521400-230	269	U8761161-230	174
U8430320	110	U8476665	163	U8495610	198	U8530501-115	287	U8776140	150 – 151
U8430330	110	U8476675	150 – 151	U8495901	295	U8530501-230	287	U9004673	266
U8430340	110	U8476713-230	120	U8495910	198	U8531050	281	U9004674	266
U8431030	108	U8476714-230	120	U8495920	198	U8531401-115	287	U99999-611	241
U8431216	110	U8476730	167	U8495930	198	U8531401-230	287	UL18575	245
U8431411	99	U8476800	176	U8496150	220	U8531408-115	194	UL29510	200 – 201
U8431776	101	U8476810	176	U8496175	220	U8531408-230	194	W11730	37
U8431805	102	U8476840	176	U8496250	231	U8531420	194	W11731	37
U8432680	111	U8476850	176	U8496255	231	U8532126	194	W11732	37
U8432770	111	U8476855	176	U8496270	224	U8532131	193	W11733	37
U8432845	103	U8476870	176	U8496320	225	U8532161	287	W11734	37
U8432850	103	U8476875	176	U8496420	168	U8533015-115	196	W11851	191
U8440012	15	U8477120-115	32 – 33	U8496460	194	U8533015-230	196	W13620	123
U8440450	142	U8477120-230	32 – 33	U8496816	88, 301	U8533341-115		W13623	123
U8440455	142	U8477130	32 – 33	U8497180	228		49, 259, 284	W13650-230	291
U8440600-115	144	U8477140	32 – 33	U8497181	230	U8533341-230		W13651-230	291
U8440600-230	144	U84780301	152	U8497200	230		49, 259, 284	W13653	291
U8441010	129	U8478080-115	152	U8497205	230	U8533370-115	285	W13654	291
U8441020	129	U8478080-230	152	U8497215	230	U8533370-230	285	W13655	291
U8441050	128	U8478090-115	152	U8497220	230	U8533380	40, 49	W16003	191
U8441301	121, 134	U8478090-230	152	U8497310	229	U8533381-115	40	W19700	248 – 249
U8442110	130	U8478110	152	U8497320	229	U8533381-230	40	W19701	248 – 249
U8442120	130	U8481320	243	U8497330	229	U8533430	259	W19721	248 – 249
U8442150	130	U8481350	243	U8497331	229	U8533510-115	272	W19722	248 – 249
U8442200	131	U8481425	245	U8497390	229	U8533510-230	272	W30600-230	294
U8442250	131	U8481430	244	U8497406	228	U8533550	273	W30614	156
U8442500	130	U8481500	225, 244	U8497410	228	U8533600-115	272	W499912	292 – 293
U8442610	301	U8481531	224	U8497420-115	228	U8533600-230	272	XP999	116
U8442620	301	U8482170	254 – 255	U8497420-230	228	U8533982	286		
U8442640	301	U8482230	254 – 255	U8497430	228	U8533997	286		
U8442835	134	U8482240	254 – 255	U8497440	228	U8533999	286		
U8451204	124 – 125	U8482260	258	U8497450	228	U8551002	202		
U8451310	124 – 125	U8482415	253	U8497460	228	U8552001	60		
U8451700	124 – 125	U8482445	253	U8497470	229	U8552003	111		
U8452570	124 – 125	U8482460	252	U8497500	226	U8552330	101		
U8460500-115	121	U8482490	260	U8497700	204	U85560081	100		
U8460500-230	121	U8482530-115		U8497740	199	U8556012	227		
U8461200	120		254 – 257	U8498030-115	21	U8556020	74		
U8461300	121	U8482530-230		U8498030-230	21	U8557000	236		
U8470110	152		254 – 257	U8498065	230	U8557001	236		
U8470120	152	U8482550-115		U8498070	230	U8557100	193		
U8470130	152		254 – 255	U8498080	230	U8557110	193		
U8470140	152	U8482550-230		U8498085	230	U8557120	193		
U8470350	152		254 – 255	U8498090	230	U8557150	260		
U8470465	152	U8482590-115	258	U8498112	230	U8557170	77		
U8470790	162	U8482590-230	258	U8498280	104 – 105	U8557180-115	107		
U8470800	161	U8483115	29, 260	U8498281	106	U8557180-230	107		
U8470870	152	U8483218	261	U8498282	104 – 105	U8557190	103		
U8472345	150 – 151	U8483219	261	U8498283-115	106	U8557210	67		
U8472580	174	U8483220	260	U8498283-230	106	U8557220	298		
U8472660	178	U8487000	264 – 265	U8498285-115	106	U8557240	221		
U8473155	177, 253	U8487010	264 – 265	U8498285-230	106	U8557250	173		
U8473200-230	156	U8487020	264 – 265	U8498287	106	U8557260	89		
U8473210-230	156	U8487030	264 – 265	U8498288-115	273	U8557270	89		
U8474000	158	U8490050	135	U8498288-230	273	U8557280	209		
U8474015	158	U8490210	193	U8498290	136	U8557290	97		
U8474030	158	U8491500	192	U8498291	136	U8557300	89		
U8474050	159	U8491790	219	U8498292	136	U8557320	107		
U8474060	168	U8491791	219	U8498293	71	U8557330	279		
U8475180	150 – 151	U8491792	219	U8498294-115	271	U8557340	76		
U8475205	150 – 151	U8491793	219	U8498294-230	271	U8557350	134		
U8475230	150 – 151	U8491810	214	U8498299-115	135	U8557370	295		
U8475240	150 – 151	U8491820	214	U8498299-230	134	U8557380	279		
U8475260	150 – 151	U8491900	216	U8498301-115	30 – 31	U8557390	301		
U8475350	150 – 151	U8491925	218	U8498301-230	30 – 31	U8557400	265		
U8475400	150 – 151	U8492030	202	U8498303	31	U8557410	265		
U8475410	150 – 151	U8492310	197	U8498304	31	U8557420	265		
U8475470-115	266	U8492320	197	U8498305	136, 267	U8557430	89		
U8475470-230	266	U8492330	197	U8498307	104 – 105	U8557440	296		
U84755401	150 – 151	U8492341	197	U8498308	104 – 105	U8557500	215		
U8475550	150 – 151	U8492350	194	U8500944	167	U8557450	63, 295		
U8475830	302	U8492355	197	U8501000	16	U8557460	295		
U8475901	150 – 151	U8493600-115	96 – 97	U8502000	18 – 19	U8557470	221		
U8475911	150 – 151	U8493600-230	96 – 97	U8503000-115	22 – 23	U8611150	296		
U8475921	150 – 151	U8495185	218	U8503000-230	22 – 23	U8611160	296		
U8475925	150 – 151	U8495210	214	U8504000	28 – 29	U8611200	296		
U8475931	150 – 151	U8495222	214	U8506000	20 – 21	U8611210	296		
U8475941	150 – 151	U8495245	216	U8511200	225	U8611460	298		
U8475951	150 – 151	U8495258	217	U8511700	47	U8611461	298		
U8475961	150 – 151	U8495310	198	U8521105-115	268	U8613283	295		
U8476110	150 – 151	U8495320	198	U8521105-230	268	U8621240	291		
U8476310	150 – 151	U8495350	199	U8521112-115	267	U8621250	291		
U8476320	150 – 151	U8495420	198	U8521112-230	267	U8624110-230	291		
U8476371	197	U8495460	198	U8521121-230	269	U8624650-115	131		

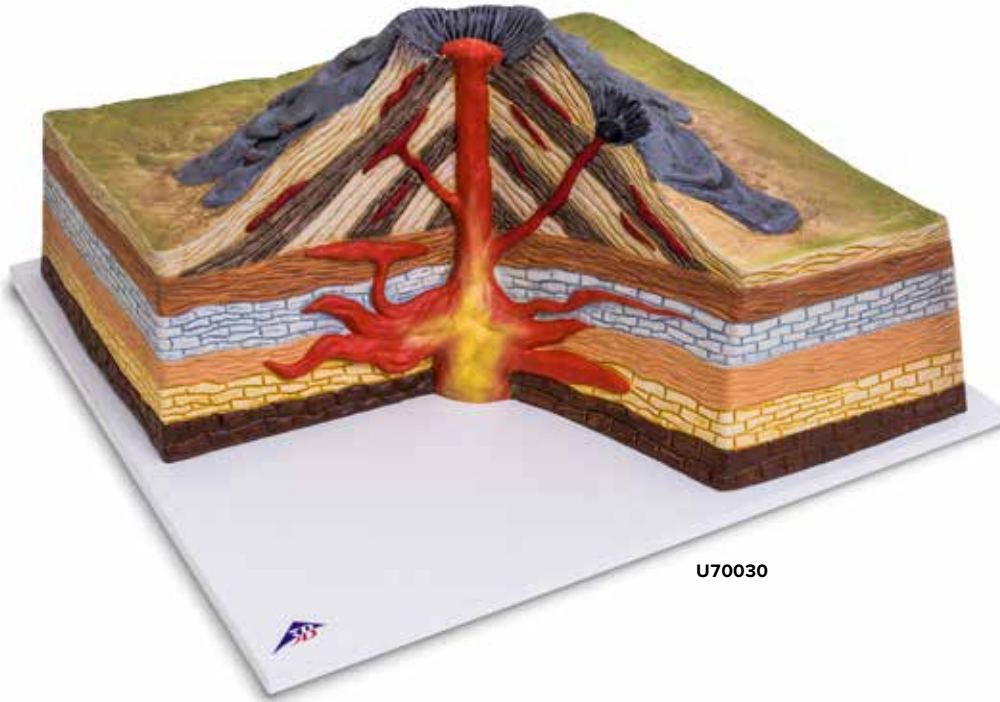

U70030

Stratovolcano

This hand-painted model of a stratovolcano with a section removed shows the path of liquid magma through the earth's interior to the exterior.

Material: PVC
 Dimensions: 47x35x19 cm
 Weight: 2.40 kg

U70030

Set of three volcanic rocks

Set of three vulcanite rocks consisting of three little bags, each containing ten walnut-sized pieces of lava rock, obsidian and pumice stone.

U72035



U72035



Mid-Atlantic Ridge

This model shows the S-shaped course in 3D of the volcanic mountain range produced by tectonic shifts in the Atlantic Ocean.

Size at the equator: 1:320.000.000
 Material: PVC
 Dimensions: 64x48x8 cm
 Weight: 6.5 kg

U70020

U70020



Collection of 24 rocks

The collections contain 24 frequently-occurring examples of various stone and mineral groups. The examples are approx. 3x3x3 cm³ to 5x5x5 cm³ in size, and come in a robust box that includes numbering, labels and information booklet.



Collection of 24 volcanic rocks and minerals

The collection contains volcanic rocks and minerals

Volcanic rocks: basalt, phonolite, pitchstone, rhyolite

Lava: Lava from Vesuvius, basaltic lava and rhyolitic lava

Pyroclasts: lapilli, volcanic ash, pumice stone
Minerals: anorthite, anorthoclase, augite, cristobalite, hauyne, leucite, natrolite, nepheline, pickeringite, sanidine, sulphur, thaumasite, tridymite, obsidian

U72010



Collection of 24 rocks

The collection contains frequently occurring examples of metamorphic, sedimentary and magmatic rocks as well as important examples of industrial rocks.

Magmatic rocks, plutonites: foyaite, gabbro, granite, granodiorite, larvikite and monzonite
 Magmatic rocks, vulcanites: basalt, pumice stone, phonolite, rhyolite

Sedimentary rocks: breccia, dolomite, gypsum, limestone, chalk, quartzite and sandstone

Metamorphic rocks: amphibolite, eclogite, mica schist, gneiss, marble, phyllite and serpentinite

U72015



Collection of 24 minerals

The collection contains examples of ten classes of minerals: elements, sulphides, halogenides, oxides, carbonates, borates, sulphates, silicates, phosphates and organic compounds.

1. Elements: graphite and sulphur

2. Sulphides: bournonite, galenite and pyrite

3. Halogenides: fluorite and halite

4. Oxides: hematite, quartz and rutile

5. Carbonates: calcite and dolomite

6. Borates: ludwigite

7. Sulphates: barite, coelestine and gypsum

8. Phosphates, arsenates and vanadates: apatite and vanadite

9. Silicates and germanates: actinolite, amazonite, muscovite, sodalite and talc

10. Organic compound: copal

U72020

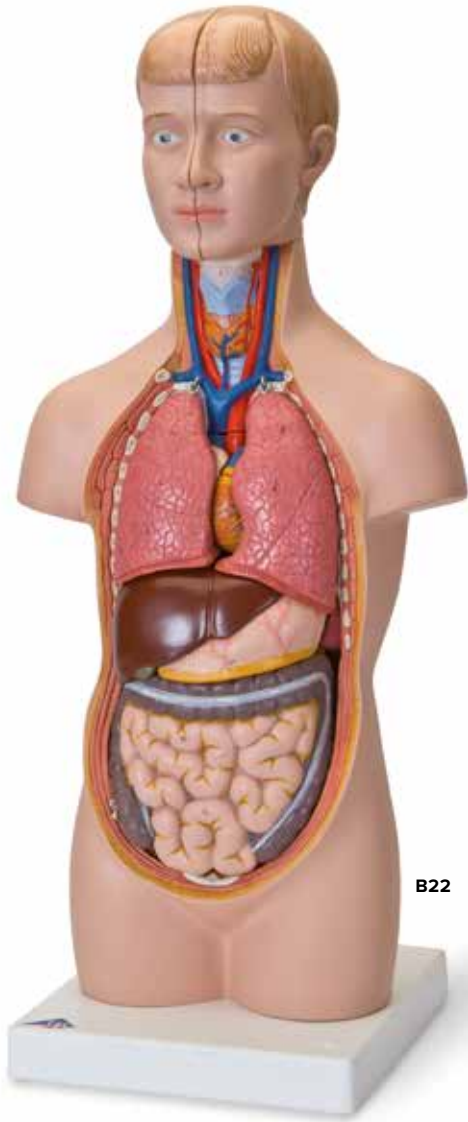

Mini Torso, 12-part

This torso is approximately half life size. Even small hands can quickly disassemble it, removing:

- 2-head halves
- Brain half
- 2 lungs
- 2-part heart
- Stomach
- Liver with gall bladder
- 2-part intestinal tract

54x24x18 cm; 1,89 kg

B22



Eye, 5 times full size, 6-part

This model dissects into:

- Both halves of sclera with cornea and eye muscle attachments
- Both halves of the choroid with iris and retina
- Lens
- Vitreous humour

On base. 9x9x15 cm; 0.1 kg

F15



Anthropological Skull – La Chapelle-aux-Saints

Cast from a reconstruction of the La Chapelle-aux-Saints skull, the model skull is an accurate copy of one belonging to a 50-55 year old male Neanderthal from ancient Europe of the species Homo (sapiens) neanderthalensis. Early man. Discovered in southern France Discovery: 1908; Age: Approximately 35,000 to 45,000 years. 22x16x22.5 cm; 0.9 kg

VP751/1



W16133

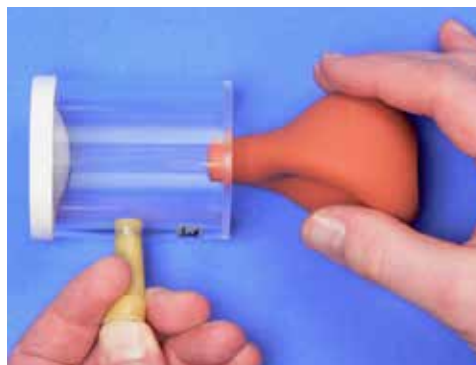

Pressure equalisation in the middle ear

This functional model shows the pressure equalising mechanism of the middle ear via the auditory tube. Bulging out or denting in of the eardrum and the subsequent equalisation of the pressure are demonstrated. Delivered with replacement membrane and teachers' manual. 16x13x12 cm, 0.2 kg

W16133

The Plant Cell

magnified 500,000-1,000,000 times

The two-piece model presents the structure of a typical plant cell with cytoplasm and cell organelles, as viewed from an electron microscope. For better illustration, all important organelles are raised and displayed in colour, e.g.:

- Cell wall
 - Cell membrane
 - Nucleus
 - Smooth Endoplasmic Reticulum
 - Rough Endoplasmic Reticulum
 - Ribosomes
 - Chloroplasts
 - Mitochondria
 - Dictyosomes/Golgi apparatus
- 20x14x32 cm; 0.8 kg

R05



R05

miniDNA™ 22 Layer Molecular Model

The miniDNA™ system comprises abstract shaped colour coded parts to represent the nitrogenous bases, pentagonal sugar and pyramidal phosphate parts required to make the Double helix model of DNA.

Contents: 11 Thymine (orange), 11 Adenine (blue) 11 Guanine (green), 11 Cytosine (yellow), 44 Deoxyribose (red), 44 Phosphate (purple)

Supplied with assembly instructions and its own stand. Packed in a plastic box. 44 cm; diam 11 cm

W19762

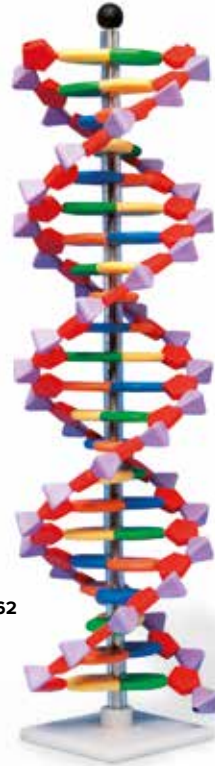

W19762



W59558

The Life of the Honeybee – Apis cerana

These vividly illustrative embedded specimens give your students an excellent insight into the world of the honeybee. Included are high quality specimens of 1. Egg, 2. Larva, 3. Pupa, 4 Adult (Worker), 5 Adult (Drone), 6. Adult (Queen), 7. The Base of Nest, 8. Worker Comb, 9. Queen Comb, 10. Bee Pollen, 11. Honey, 12. Wax.

165x80x25 mm; 150 g
W59558



T21019

Cherry Blossom with Fruit (Prunus Avium)

This model shows the blossom of the sweet cherry (3-parts) enlarged 7 times as well as a cherry fruit enlarged 3 times. The cherry blossom can be split into two halves to reveal the removable ovary with style and stigma.

32,5 cm; 0,6 kg
T21019

Fire Salamander (Salamandra salamandra)

A salamander which will be particularly loved by younger students. The fire salamander is painted with stunning realism and its identifying characteristics are clear to see. It is a life-size facsimile modelled on natural background.

VN700



VN700



W19927



DNA Extraction from Onion

With this easy test on the theme of cellular biology and genetics, you can isolate chromosomal DNA from an onion without a long preparation time, during a class. Your students will learn thanks to this experiment about the basic process of DNA extraction. Everything is included in the kit so that 5 groups can work at the same time. This effective classroom experiment with a high DNA yield will provide enjoyment for your students.

Contents for 15 experiments:

80 ml extraction buffer, 500 mg protease mix, 15 flat-bottomed tubes, 15 round paper filters, 5 funnels, 15 wooden picks, experiment instructions (multilingual).

Dimensions: 20.5x20.5x10.5 cm

Weight: 534 g

W19927

Monocular Course Microscope Model 300 (230 V, 50/60 Hz)

The model 300 course microscope meets all the requirements for high-quality biology lessons. It is characterised by its ease of use and its fine mechanical and optical qualities. It is equipped with an object stage, 4-objective revolver with DIN achromatic objectives featuring 4x, 10x, 40x, 100x magnification and an Abbe condenser.

U30705-230



U30705-230

Dissecting instruments

This first-rate dissecting set contains top-quality stainless steel instruments in an attractive vinyl case.

- 1 pair of scissors, pointed, 10 cm
 - 1 pair of forceps, pointed, 13 cm
 - 1 dissecting needle, 13.5 cm
 - 1 scalpel blade holder n° 4
 - 5 replacement scalpel blades n° 11
- 18x8x3 cm, 0,15 kg

W11609



W11609

3B Scientific® Physics Production in Germany, Klingenthal

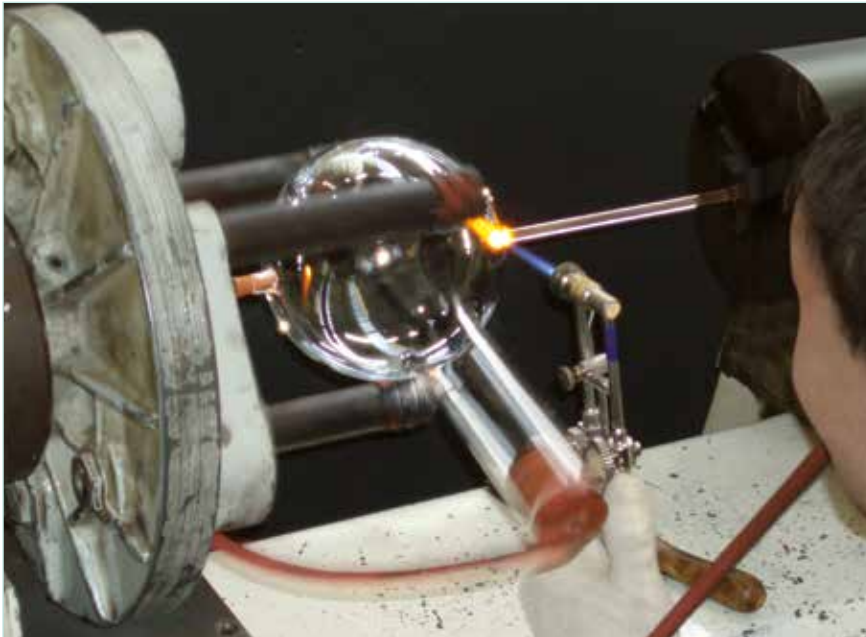

Manufacturing a TELTRON® electron tube at 3B Scientific in Germany

Electron tubes are produced at only a very small number of places in the world. Only specially trained technicians with many years of experience have the skills that are needed for this technologically advanced manufacturing process, which ensures that every TELTRON® electron tube that you receive from us will have the same consistently high quality.



Assembly production at the CNC Processing Centre

The universally recognised high quality of the teaching equipment produced is achieved through a combination of modern process technology with the best traditional craftsmanship. The skills and facilities of the CNC Processing Centre in Klingenthal guarantee not only the mechanical precision that is essential for high-quality physical instruments, but also cost-effective series production with consistently high quality.



A CAD/CAM workstation

A direct extension from the principles of CAD (Computer Aided Design) is CAM (Computer Aided Manufacturing), here shown being applied to controlling a flat-bed milling machine. This manufacturing technology makes it possible to fulfil special project requirements with speed and with the usual high precision.

► Maltese Cross Tube S

Highly evacuated electron tube with divergent electron gun, fluorescent screen and Maltese cross. For demonstrating the straight line propagation of electrons in the absence of any electric or magnetic field by projecting the shadow of a Maltese cross onto the fluorescent screen and for introducing students to electron optics.

Please see page 238

